



Chipsmall Limited consists of a professional team with an average of over 10 year of expertise in the distribution of electronic components. Based in Hongkong, we have already established firm and mutual-benefit business relationships with customers from,Europe,America and south Asia,supplying obsolete and hard-to-find components to meet their specific needs.

With the principle of “Quality Parts,Customers Priority,Honest Operation,and Considerate Service”,our business mainly focus on the distribution of electronic components. Line cards we deal with include Microchip,ALPS,ROHM,Xilinx,Pulse,ON,Everlight and Freescale. Main products comprise IC,Modules,Potentiometer,IC Socket,Relay,Connector.Our parts cover such applications as commercial,industrial, and automotives areas.

We are looking forward to setting up business relationship with you and hope to provide you with the best service and solution. Let us make a better world for our industry!



Contact us

Tel: +86-755-8981 8866 Fax: +86-755-8427 6832

Email & Skype: info@chipsmall.com Web: www.chipsmall.com

Address: A1208, Overseas Decoration Building, #122 Zhenhua RD., Futian, Shenzhen, China





Is Now Part of



ON Semiconductor®

To learn more about ON Semiconductor, please visit our website at

www.onsemi.com

ON Semiconductor and the ON Semiconductor logo are trademarks of Semiconductor Components Industries, LLC dba ON Semiconductor or its subsidiaries in the United States and/or other countries. ON Semiconductor owns the rights to a number of patents, trademarks, copyrights, trade secrets, and other intellectual property. A listing of ON Semiconductor's product/patent coverage may be accessed at www.onsemi.com/site/pdf/Patent-Marking.pdf. ON Semiconductor reserves the right to make changes without further notice to any products herein. ON Semiconductor makes no warranty, representation or guarantee regarding the suitability of its products for any particular purpose, nor does ON Semiconductor assume any liability arising out of the application or use of any product or circuit, and specifically disclaims any and all liability, including without limitation special, consequential or incidental damages. Buyer is responsible for its products and applications using ON Semiconductor products, including compliance with all laws, regulations and safety requirements or standards, regardless of any support or applications information provided by ON Semiconductor. "Typical" parameters which may be provided in ON Semiconductor data sheets and/or specifications can and do vary in different applications and actual performance may vary over time. All operating parameters, including "Typicals" must be validated for each customer application by customer's technical experts. ON Semiconductor does not convey any license under its patent rights nor the rights of others. ON Semiconductor products are not designed, intended, or authorized for use as a critical component in life support systems or any FDA Class 3 medical devices or medical devices with a same or similar classification in a foreign jurisdiction or any devices intended for implantation in the human body. Should Buyer purchase or use ON Semiconductor products for any such unintended or unauthorized application, Buyer shall indemnify and hold ON Semiconductor and its officers, employees, subsidiaries, affiliates, and distributors harmless against all claims, costs, damages, and expenses, and reasonable attorney fees arising out of, directly or indirectly, any claim of personal injury or death associated with such unintended or unauthorized use, even if such claim alleges that ON Semiconductor was negligent regarding the design or manufacture of the part. ON Semiconductor is an Equal Opportunity/Affirmative Action Employer. This literature is subject to all applicable copyright laws and is not for resale in any manner.

FIN1047

3.3V LVDS 4-Bit Flow-Through High Speed Differential Driver

General Description

This quad driver is designed for high speed interconnects utilizing Low Voltage Differential Signaling (LVDS) technology. The driver translates LVTTTL signal levels to LVDS levels with a typical differential output swing of 350mV which provides low EMI at ultra low power dissipation even at high frequencies. This device is ideal for high speed transfer of clock and data.

The FIN1047 can be paired with its companion receiver, the FIN1048, or any other LVDS receiver.

Features

- Greater than 400Mbps data rate
- Flow-through pinout simplifies PCB layout
- 3.3V power supply operation
- 0.4 ns maximum differential pulse skew
- 1.7 ns maximum propagation delay
- Low power dissipation
- Power-Off protection
- Meets or exceeds the TIA/EIA-644 LVDS standard
- Pin compatible with equivalent RS-422 and LVPECL devices
- 16-Lead SOIC and TSSOP packages save space

Ordering Code:

Order Number	Package Number	Package Description
FIN1047M	M16A	16-Lead Small Outline Integrated Circuit (SOIC), JEDEC MS-012, 0.150" Narrow
FIN1047MTC	MTC16	16-Lead Thin Shrink Small Outline Package (TSSOP), JEDEC MO-153, 4.4mm Wide

Devices also available in Tape and Reel. Specify by appending the suffix letter "X" to the ordering code.

Connection Diagram

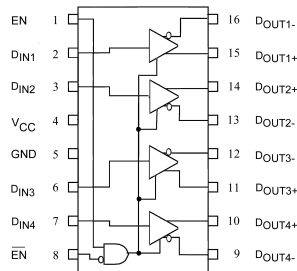

Pin Descriptions

Pin Name	Description
D _{IN1} , D _{IN2} , D _{IN3} , D _{IN4}	LVTTTL Data Inputs
D _{OUT1+} , D _{OUT2+} , D _{OUT3+} , D _{OUT4+}	Non-Inverting Driver Outputs
D _{OUT1-} , D _{OUT2-} , D _{OUT3-} , D _{OUT4-}	Inverting Driver Outputs
EN	Driver Enable Pin
$\overline{\text{EN}}$	Inverting Driver Enable Pin
V _{CC}	Power Supply
GND	Ground

Truth Table

Inputs			Outputs	
EN	$\overline{\text{EN}}$	D _{IN}	D _{OUT+}	D _{OUT-}
H	L or OPEN	H	H	L
H	L or OPEN	L	L	H
H	L or OPEN	OPEN	L	H
X	H	X	Z	Z
L or OPEN	X	X	Z	Z

H = HIGH Logic Level L = LOW Logic Level
X = Don't Care Z = High Impedance

Absolute Maximum Ratings(Note 1)

Supply Voltage (V_{CC})	-0.5V to +4.6V
DC Input Voltage (V_{IN})	-0.5V to +6V
DC Input Voltage (V_{OUT})	-0.5V to 4.6V
Driver Short Circuit Current (I_{OSD})	Continuous
Storage Temperature Range (T_{STG})	-65°C to +150°C
Max Junction Temperature (T_J)	150°C
Lead Temperature (T_L) (Soldering, 10 seconds)	260°C
ESD (Human Body Model)	≥ 9000V
ESD (Machine Model)	≥ 1200V

Recommended Operating Conditions

Supply Voltage (V_{CC})	3.0V to 3.6V
Input Voltage (V_{IN})	0 to V_{CC}
Operating Temperature (T_A)	-40°C to +85°C

Note 1: The "Absolute Maximum Ratings": are those values beyond which damage to the device may occur. The databook specifications should be met, without exception, to ensure that the system design is reliable over its power supply, temperature and output/input loading variables. Fairchild does not recommend operation of circuits outside databook specification.

DC Electrical Characteristics

Over supply voltage and operating temperature ranges, unless otherwise specified

Symbol	Parameter	Test Conditions	Min	Typ (Note 2)	Max	Units	
V_{OD}	Output Differential Voltage	$R_L = 100\Omega$, Driver Enabled, See Figure 1	250	340	450	mV	
ΔV_{OD}	V_{OD} Magnitude Change from Differential LOW-to-HIGH			1.4	25	mV	
V_{OS}	Offset Voltage			1.125	1.25	1.375	V
ΔV_{OS}	Offset Magnitude Change from Differential LOW-to-HIGH				1.2	25	mV
V_{OH}	HIGH Output Voltage	$V_{IN} = V_{CC}$		1.4	1.6	V	
V_{OL}	LOW Output Voltage	$V_{IN} = 0V$	0.9	1.05		V	
I_{OFF}	Power Off Output Current	$V_{CC} = 0V$, $V_{OUT} = 0V$ or 3.6V	-20		20	μA	
I_{OS}	Short Circuit Output Current	$V_{OUT} = 0V$, Driver Enabled		-3	-6	mA	
		$V_{OD} = 0V$, Driver Enabled		-3.5	-6		
V_{IH}	Input HIGH Voltage		2.0		$V_{CC} + 1.0$	V	
V_{IL}	Input LOW Voltage (Note 3)		GND		0.8	V	
I_{IN}	Input Current	$V_{IN} = 0V$ or V_{CC}	-20		20	μA	
I_{OZ}	Disabled Output Leakage Current	$V_{OUT} = 0V$ or 4.6V	-20		20	μA	
$I_{I(OFF)}$	Power-Off Input Current	$V_{CC} = 0V$, $V_{IN} = 0V$ or 3.6V	-20		20	μA	
V_{IK}	Input Clamp Voltage	$I_{IK} = -18$ mA	-1.5	-0.7		V	
I_{CC}	Power Supply Current	No Load, $V_{IN} = 0V$ or V_{CC} , Driver Enabled		5	8	mA	
		$R_L = 100\Omega$, Driver Disabled		1.7	4		
		$R_L = 100\Omega$, $V_{IN} = 0V$ or V_{CC} , Driver Enabled		16	22		
$I_{PU/PD}$	Output Power Up/Power Down High Z Leakage Current	$V_{CC} = 0V$ or 1.5V	-20		20	μA	

Note 2: All typical values are at $T_A = 25^\circ C$ and with $V_{CC} = 3.3V$.

Note 3: For transient conditions when $t \leq 5$ ns and $I_{IN} \leq -100$ mA, $V_{ILmin} = -1.0V$.

AC Electrical Characteristics

Over supply voltage and operating temperature ranges, unless otherwise specified

Symbol	Parameter	Test Conditions	Min	Typ (Note 4)	Max	Units
t_{PLHD}	Differential Propagation Delay LOW-to-HIGH	$R_L = 100\ \Omega$, $C_L = 10\ \text{pF}$, See Figure 2 (Note 8), and Figure 3	0.6	1.1	1.7	ns
t_{PHLD}	Differential Propagation Delay HIGH-to-LOW		0.6	1.2	1.7	ns
t_{TLHD}	Differential Output Rise Time (20% to 80%)		0.4		1.2	ns
t_{THLD}	Differential Output Fall Time (80% to 20%)		0.4		1.2	ns
$t_{SK(P)}$	Pulse Skew $ t_{PLH} - t_{PHL} $				0.4	ns
$t_{SK(LH)}$	Channel-to-Channel Skew (Note 5)			0.05	0.3	ns
$t_{SK(HL)}$	Channel-to-Channel Skew (Note 5)				0.3	ns
$t_{SK(PP)}$	Part-to-Part Skew (Note 6)			1.0	ns	
f_{MAX}	Maximum Frequency (Note 7)	$R_L = 100\ \Omega$, See Figure 6 (Note 8)	200	250		MHz
t_{ZHD}	Differential Output Enable Time from Z to HIGH	$R_L = 100\ \Omega$, $C_L = 10\ \text{pF}$, See Figure 4 (Note 8), and Figure 5		1.7	5.0	ns
t_{ZLD}	Differential Output Enable Time from Z to LOW			1.7	5.0	ns
t_{HZD}	Differential Output Disable Time from HIGH to Z			2.7	5.0	ns
t_{LZD}	Differential Output Disable Time from LOW to Z			2.7	5.0	ns
C_{IN}	Input Capacitance			4.2		pF
C_{OUT}	Output Capacitance			5.2		pF

Note 4: All typical values are at $T_A = 25^\circ\text{C}$ and with $V_{CC} = 3.3\text{V}$.

Note 5: $t_{SK(LH)}$, $t_{SK(HL)}$ is the skew between specified outputs of a single device when the outputs have identical loads and are switching in the same direction.

Note 6: $t_{SK(PP)}$ is the magnitude of the difference in propagation delay times between any specified terminals of two devices switching in the same direction (either LOW-to-HIGH or HIGH-to-LOW) when both devices operate with the same supply voltage, same temperature, and have identical test circuits.

Note 7: f_{MAX} criteria: Input $t_R = t_F < 1\ \text{ns}$, 0V to 3V, 50% Duty Cycle; Output $V_{OD} > 250\ \text{mV}$, 45% to 55% Duty Cycle; all switching in phase channels.

Note 8: Test Circuits in Figures 2, 4, 6 are simplified representations of test fixture and DUT loading.

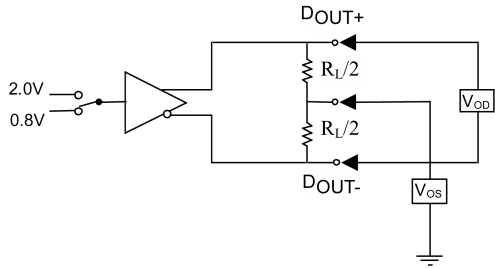
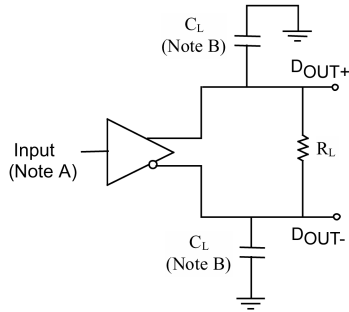

FIGURE 1. Differential Driver DC Test Circuit



Note A: All input pulses have frequency = 10 MHz, t_R or t_F = 1 ns
Note B: C_L includes all fixture and instrumentation capacitance

FIGURE 2. Differential Driver Propagation Delay and Transition Time Test Circuit

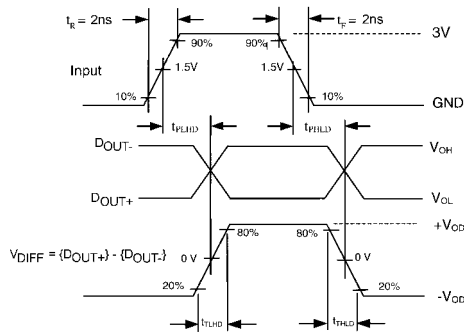
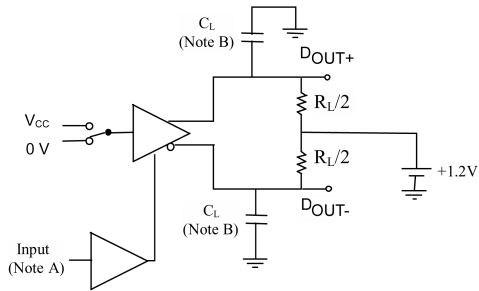

FIGURE 3. AC Waveforms



Note B: All input pulses have the frequency = 10 MHz, t_R or t_F = 1 ns
Note A: C_L includes all fixture and instrumentation capacitance

FIGURE 4. Differential Driver Enable and Disable Test Circuit

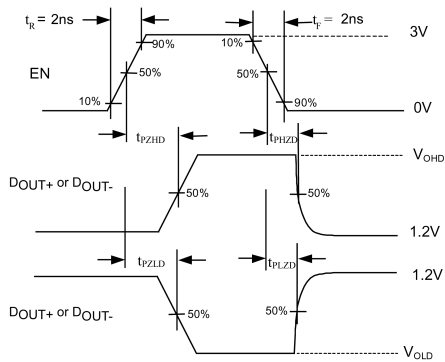

FIGURE 5. Enable and Disable AC Waveforms

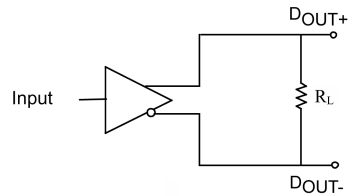

FIGURE 6. f_{MAX} Test Circuit

DC / AC Typical Performance Curves

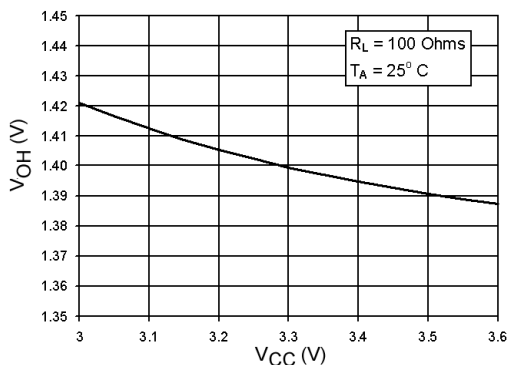

FIGURE 7. Output High Voltage vs. Power Supply Voltage

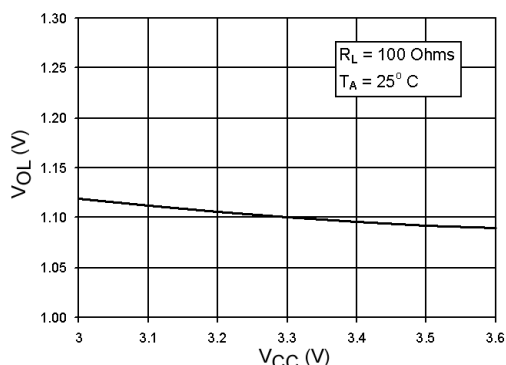

FIGURE 8. Output Low Voltage vs. Power Supply Voltage

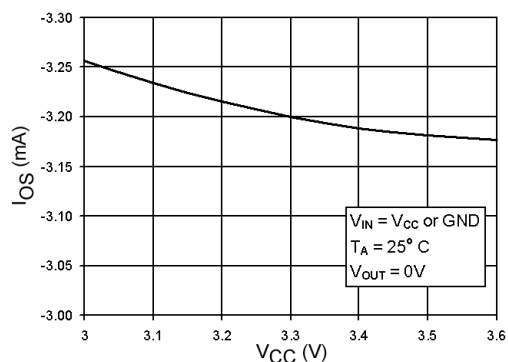

FIGURE 9. Output Short Circuit Current vs. Power Supply Voltage

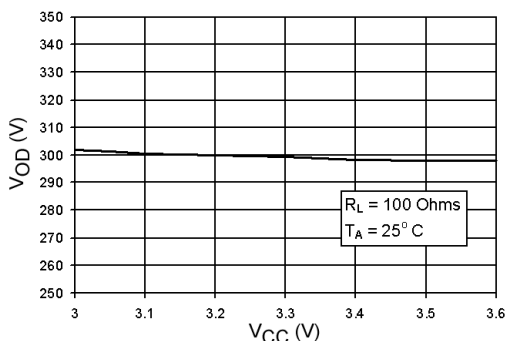

FIGURE 10. Differential Output Voltage vs. Power Supply Voltage

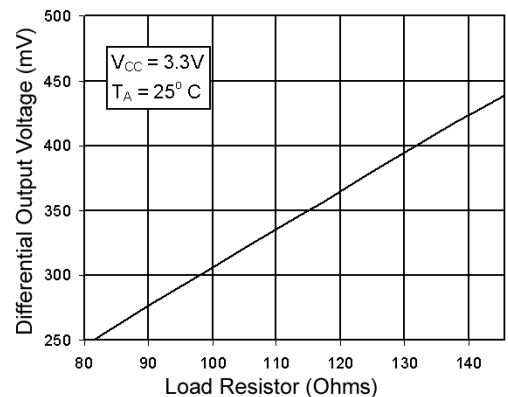

FIGURE 11. Differential Output Voltage vs. Load Resistor

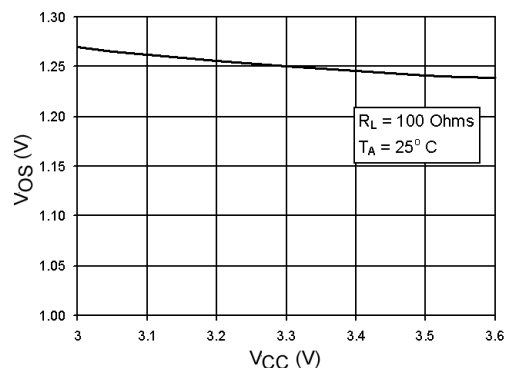

FIGURE 12. Offset Voltage vs. Power Supply Voltage

DC / AC Typical Performance Curves (Continued)

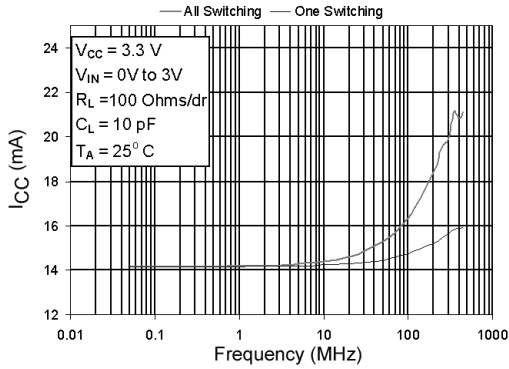

FIGURE 13. Power Supply Current vs. Frequency

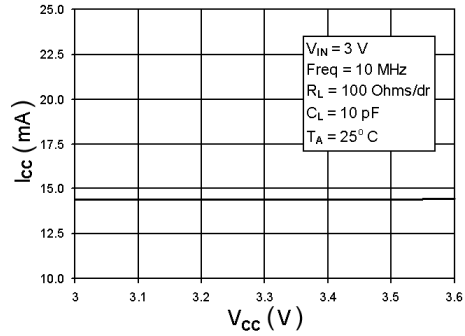

FIGURE 14. Power Supply Current vs. Power Supply Voltage

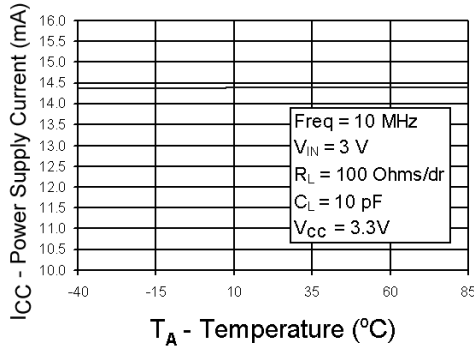

FIGURE 15. Power Supply Current vs. Ambient Temperature

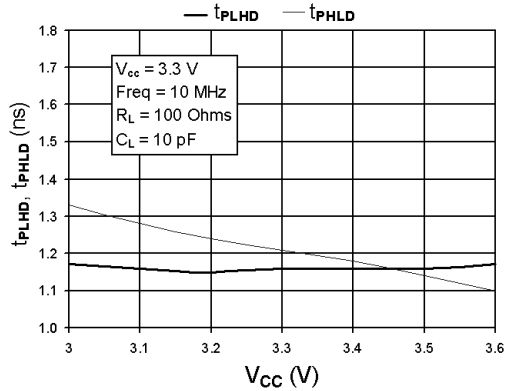

FIGURE 16. Differential Propagation Delay vs. Power Supply Voltage

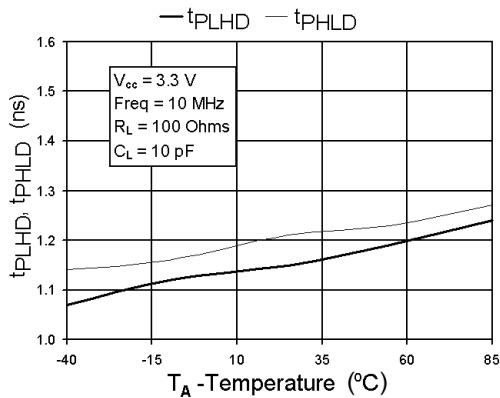

FIGURE 17. Differential Propagation Delay vs. Ambient Temperature

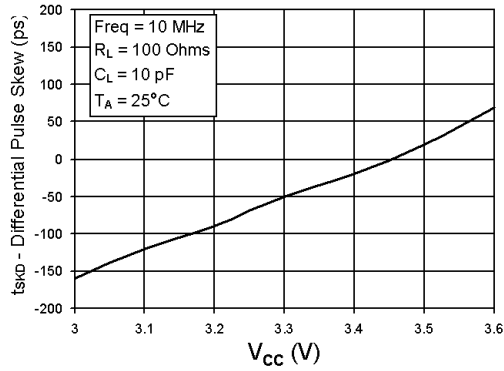

FIGURE 18. Differential Pulse Skew ($t_{PLH} - t_{PHL}$) vs. Power Supply Voltage

DC / AC Typical Performance Curves (Continued)

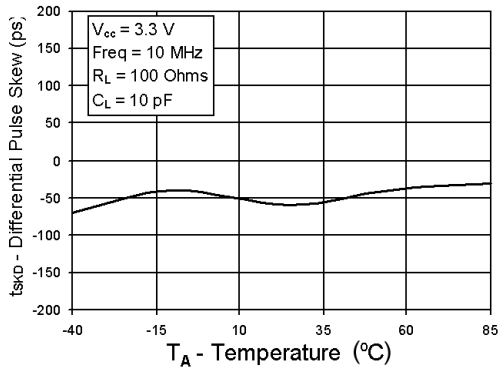

FIGURE 19. Differential Pulse Skew ($t_{PLH} - t_{PHL}$) vs. Ambient Temperature

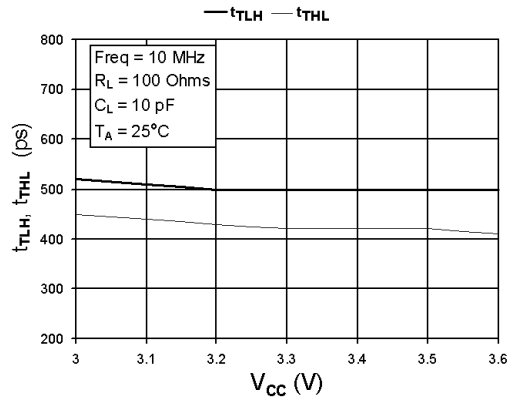

FIGURE 20. Transition Time vs. Power Supply Voltage

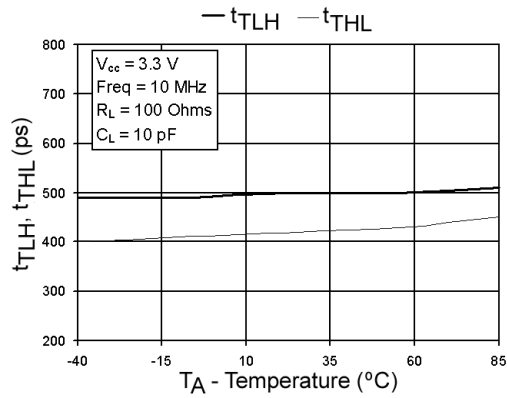
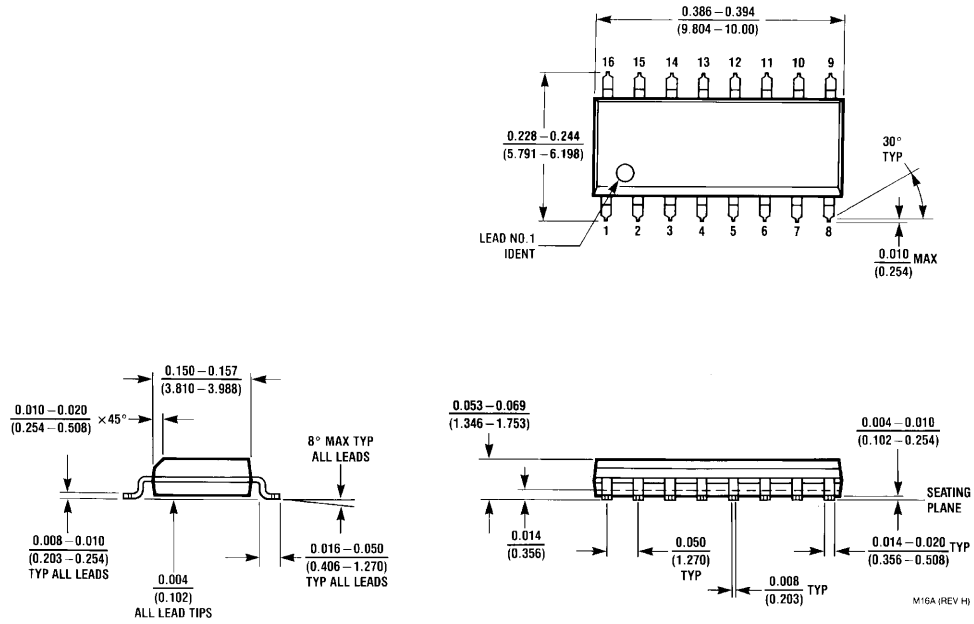

FIGURE 21. Transition Time vs. Ambient Temperature

Physical Dimensions inches (millimeters) unless otherwise noted



16-Lead Small Outline Integrated Circuit (SOIC), JEDEC MS-012, 0.150" Narrow Package Number M16A

Physical Dimensions inches (millimeters) unless otherwise noted (Continued)

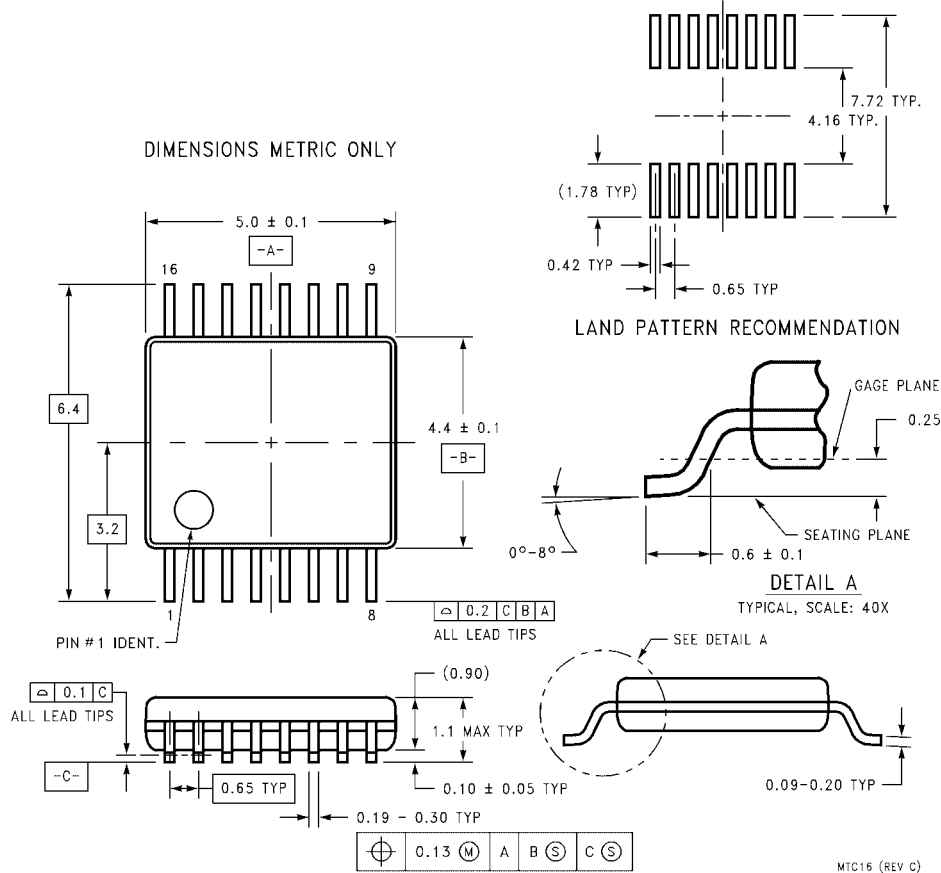

**16-Lead Thin Shrink Small Outline Package (TSSOP), JEDEC MO-153, 4.4mm Wide
Package Number MTC16**

Fairchild does not assume any responsibility for use of any circuitry described, no circuit patent licenses are implied and Fairchild reserves the right at any time without notice to change said circuitry and specifications.

LIFE SUPPORT POLICY

FAIRCHILD'S PRODUCTS ARE NOT AUTHORIZED FOR USE AS CRITICAL COMPONENTS IN LIFE SUPPORT DEVICES OR SYSTEMS WITHOUT THE EXPRESS WRITTEN APPROVAL OF THE PRESIDENT OF FAIRCHILD SEMICONDUCTOR CORPORATION. As used herein:

1. Life support devices or systems are devices or systems which, (a) are intended for surgical implant into the body, or (b) support or sustain life, and (c) whose failure to perform when properly used in accordance with instructions for use provided in the labeling, can be reasonably expected to result in a significant injury to the user.
2. A critical component in any component of a life support device or system whose failure to perform can be reasonably expected to cause the failure of the life support device or system, or to affect its safety or effectiveness.

www.fairchildsemi.com

ON Semiconductor and  are trademarks of Semiconductor Components Industries, LLC dba ON Semiconductor or its subsidiaries in the United States and/or other countries. ON Semiconductor owns the rights to a number of patents, trademarks, copyrights, trade secrets, and other intellectual property. A listing of ON Semiconductor's product/patent coverage may be accessed at www.onsemi.com/site/pdf/Patent-Marking.pdf. ON Semiconductor reserves the right to make changes without further notice to any products herein. ON Semiconductor makes no warranty, representation or guarantee regarding the suitability of its products for any particular purpose, nor does ON Semiconductor assume any liability arising out of the application or use of any product or circuit, and specifically disclaims any and all liability, including without limitation special, consequential or incidental damages. Buyer is responsible for its products and applications using ON Semiconductor products, including compliance with all laws, regulations and safety requirements or standards, regardless of any support or applications information provided by ON Semiconductor. "Typical" parameters which may be provided in ON Semiconductor data sheets and/or specifications can and do vary in different applications and actual performance may vary over time. All operating parameters, including "Typicals" must be validated for each customer application by customer's technical experts. ON Semiconductor does not convey any license under its patent rights nor the rights of others. ON Semiconductor products are not designed, intended, or authorized for use as a critical component in life support systems or any FDA Class 3 medical devices or medical devices with a same or similar classification in a foreign jurisdiction or any devices intended for implantation in the human body. Should Buyer purchase or use ON Semiconductor products for any such unintended or unauthorized application, Buyer shall indemnify and hold ON Semiconductor and its officers, employees, subsidiaries, affiliates, and distributors harmless against all claims, costs, damages, and expenses, and reasonable attorney fees arising out of, directly or indirectly, any claim of personal injury or death associated with such unintended or unauthorized use, even if such claim alleges that ON Semiconductor was negligent regarding the design or manufacture of the part. ON Semiconductor is an Equal Opportunity/Affirmative Action Employer. This literature is subject to all applicable copyright laws and is not for resale in any manner.

PUBLICATION ORDERING INFORMATION

LITERATURE FULFILLMENT:

Literature Distribution Center for ON Semiconductor
19521 E. 32nd Pkwy, Aurora, Colorado 80011 USA
Phone: 303-675-2175 or 800-344-3860 Toll Free USA/Canada
Fax: 303-675-2176 or 800-344-3867 Toll Free USA/Canada
Email: orderlit@onsemi.com

N. American Technical Support: 800-282-9855 Toll Free
USA/Canada
Europe, Middle East and Africa Technical Support:
Phone: 421 33 790 2910
Japan Customer Focus Center
Phone: 81-3-5817-1050

ON Semiconductor Website: www.onsemi.com
Order Literature: <http://www.onsemi.com/orderlit>
For additional information, please contact your local
Sales Representative