



Chipsmall Limited consists of a professional team with an average of over 10 year of expertise in the distribution of electronic components. Based in Hongkong, we have already established firm and mutual-benefit business relationships with customers from,Europe,America and south Asia,supplying obsolete and hard-to-find components to meet their specific needs.

With the principle of “Quality Parts,Customers Priority,Honest Operation,and Considerate Service”,our business mainly focus on the distribution of electronic components. Line cards we deal with include Microchip,ALPS,ROHM,Xilinx,Pulse,ON,Everlight and Freescale. Main products comprise IC,Modules,Potentiometer,IC Socket,Relay,Connector.Our parts cover such applications as commercial,industrial, and automotives areas.

We are looking forward to setting up business relationship with you and hope to provide you with the best service and solution. Let us make a better world for our industry!



## Contact us

Tel: +86-755-8981 8866 Fax: +86-755-8427 6832

Email & Skype: info@chipsmall.com Web: www.chipsmall.com

Address: A1208, Overseas Decoration Building, #122 Zhenhua RD., Futian, Shenzhen, China





## Features

Package	<p>φ3 flush mount through-hole type          Lens color : Pale Red, Clear</p>
Product features	<ul style="list-style-type: none"> <li>• Blowhole-free structure              Blowhole is a type of defect which mostly occurs in direct mounting LED. Moisture absorbed by PCB during soldering, might get vaporization and puncture holes in solder.              Blowhole-free is a new structure which can prevent the occurrence of blowhole.</li> <li>• Lead-free soldering compatible</li> <li>• RoHS compliant</li> </ul>

## Recommended Applications

- Communication Machine, Electric Household Appliances, OA/FA, Other General Applications



## 【 Product Overview 】

Die Material	AlGaInP
Emitting Colpr	Red
Resin Color	Pale Red, Clear

## 【 Absolute Maximum Ratings 】

(Ta=25°C)

ITEM	SYMBOL	MAXIMUM RATINGS	UNITS	
Power Dissipation	$P_d$	125	mW	
Forward Current	$I_F$	50	mA	
Repetitive Peak Forward Current	$I_{FRM}$	100	mA	Notes1
$I_F$ Derate Linearly from "25°C"	$\Delta I_F$	0.67	mA/°C	
$I_{FRM}$ Derate Linearly from "25°C"	$\Delta I_{FRM}$	1.33	mA/°C	
Reverse Voltage	$V_R$	5	V	
Operating Temperature	$T_{opr}$	-40 ~ +85	°C	
Storage Temperature	$T_{stg}$	-40 ~ +100	°C	
Electrostatic Discharge Threshold "HBM"	ESD	1,000	V	Notes2
Soldering Temperature "Dip Soldering"	$T_{sld}$	265	°C	Notes3

Note 1  $I_{FRM}$  Conditions : Pulse Width  $\leq 1ms$  , Duty  $\leq 1/20$

Note 2 ESD testing method : EIAJ4071/300(304) Human Body Model(HBM) 1.5k $\Omega$  ,100pF

Note 3 Please refer to Page 9, Handling precaution of Flush mount LED Lamp,Soldering precaution for details.



## 【 Electro and Optical Characteristics 】

(Ta=25°C)

ITEM	SYMBOL	CONDITIONS	MIN.	TYP.	MAX.	UNITS
Forward Voltage	$V_F$	$I_F = 20\text{mA}$	1.8	2.2	2.5	V
Reverse Current	$I_R$	$V_R = 5\text{V}$	-	-	100	$\mu\text{A}$
Luminous Intensity	$I_V$	$I_F = 20\text{mA}$	500	1,000	-	mcd
Peak Wavelength	$\lambda_p$	$I_F = 20\text{mA}$	-	635	-	nm
Dominant Wavelength	$\lambda_d$	$I_F = 20\text{mA}$	618	625	630	nm
Spectral Line Half Width	$\Delta\lambda$	$I_F = 20\text{mA}$	-	20	-	nm

## 【 Sorting chart For Luminous Intensity 】

LEDs shall be sorted out into the following 6 ranks of Luminous Intensity.

Rank	$I_V$ (mcd)		Condiiton
	MIN.	MAX.	
A	500	1,000	$I_F = 20\text{mA}$ $T_a = 25^\circ\text{C}$
B	700	1,400	
C	1,000	2,000	
D	1,400	2,800	
E	2,000	4,000	
F	2,800	-	

## 【 Rank Marking 】

Luminous Intensity rank is indicated by lot number on the product label.

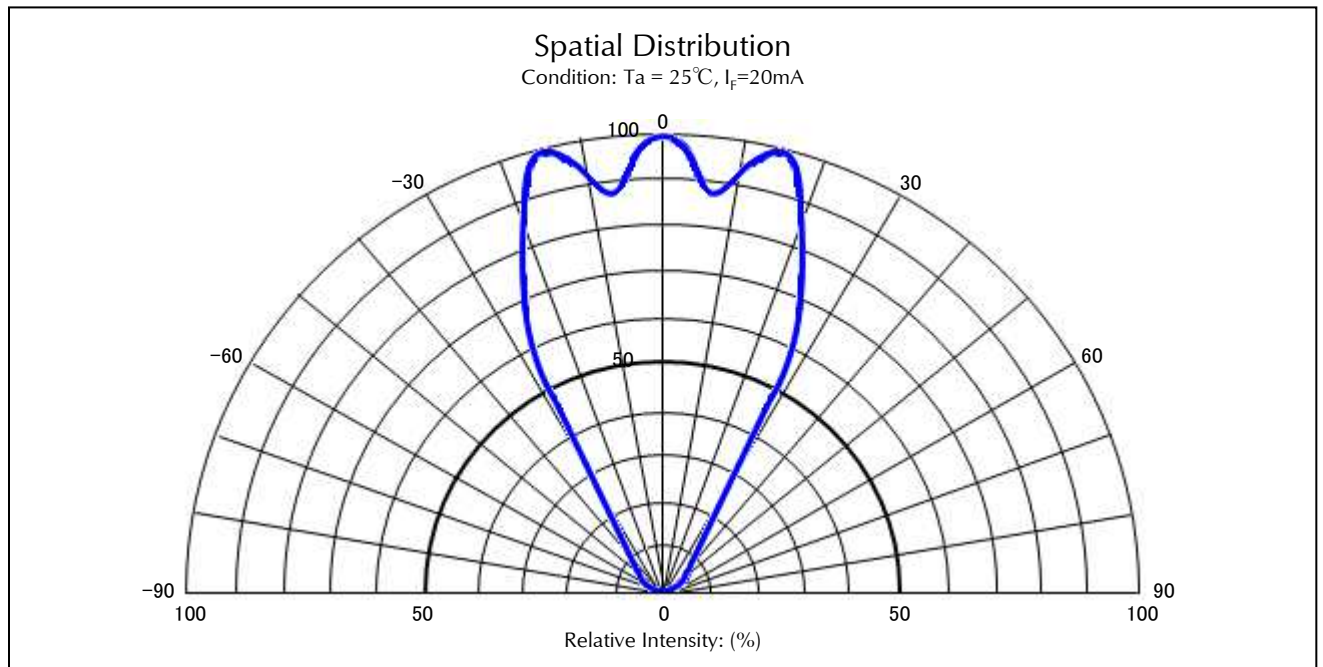
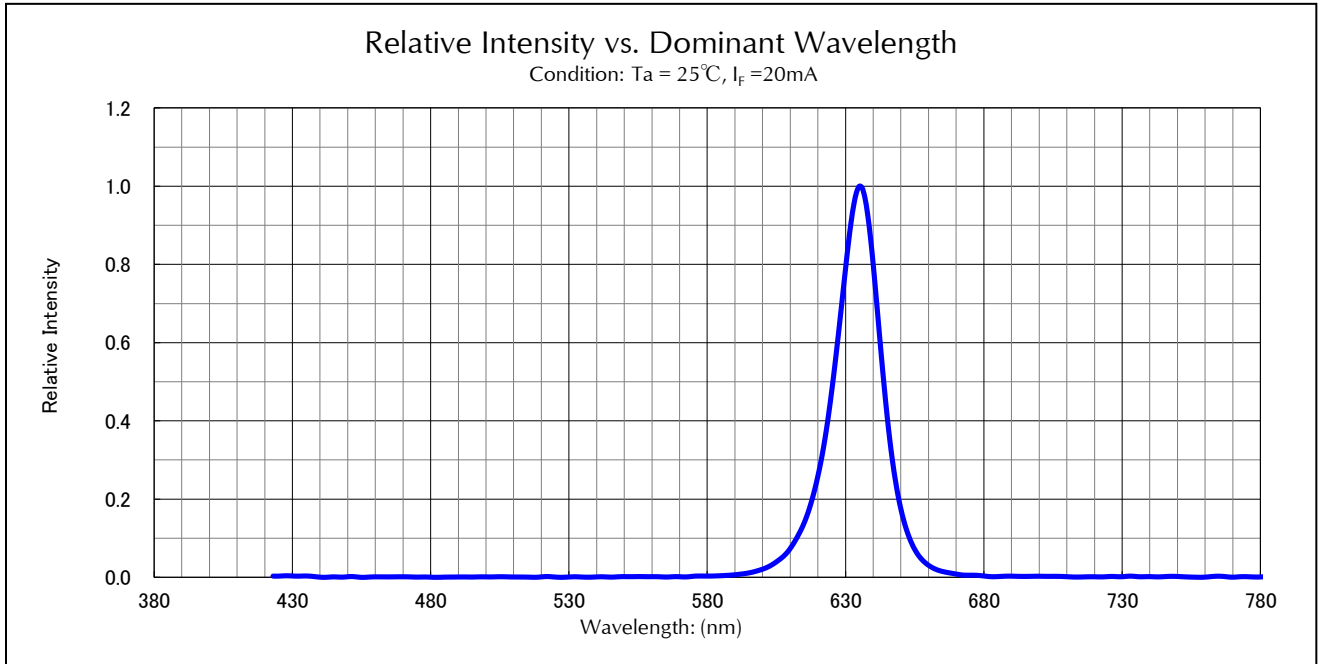

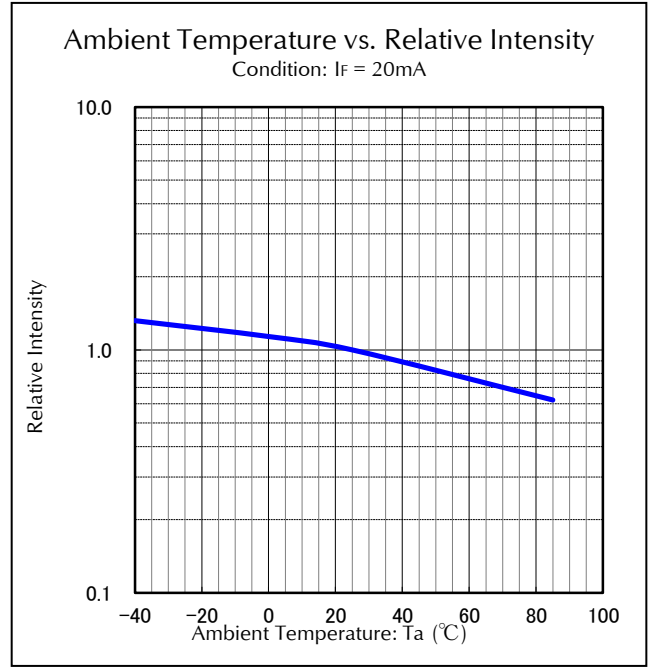
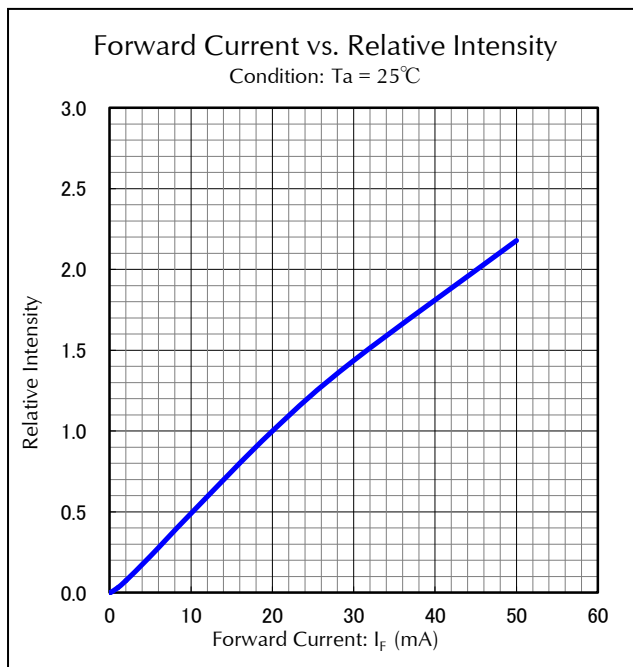
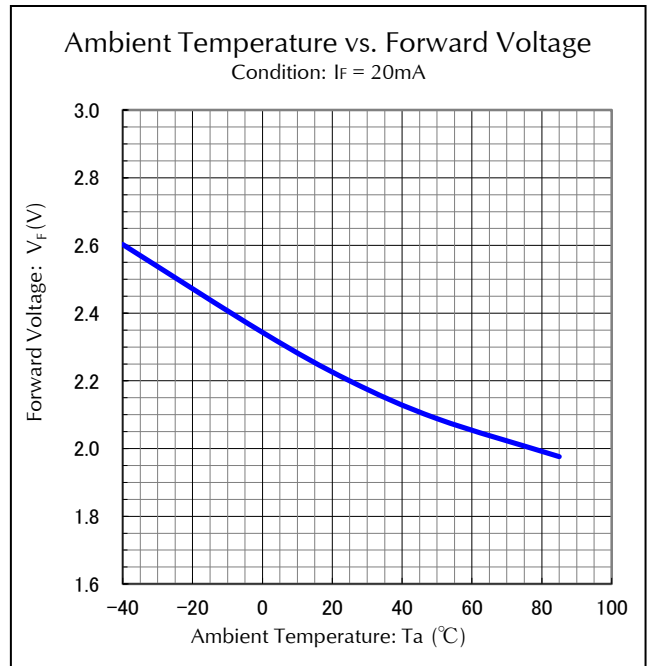
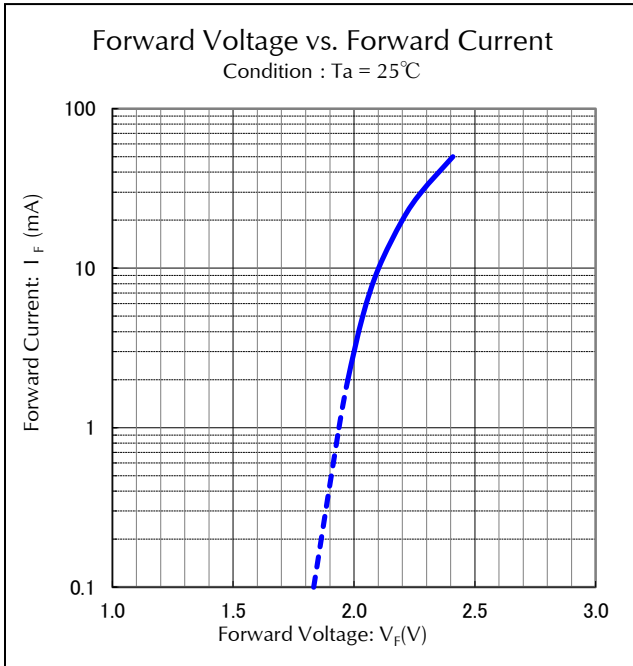

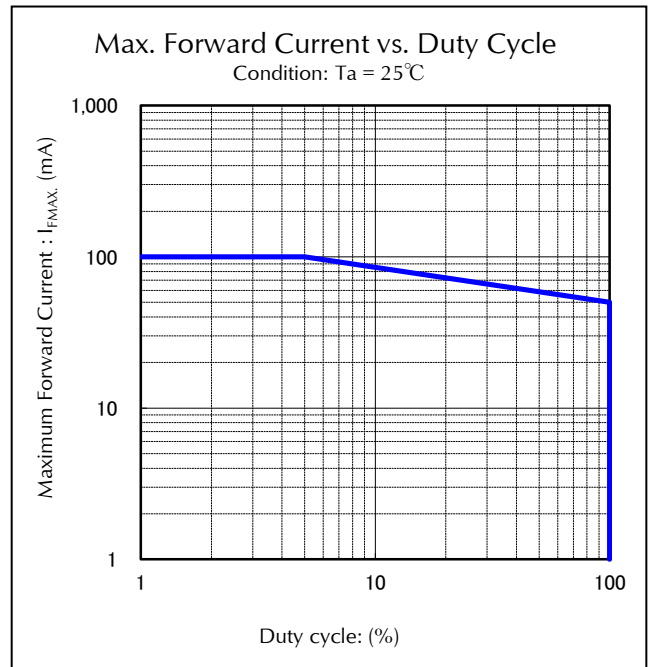
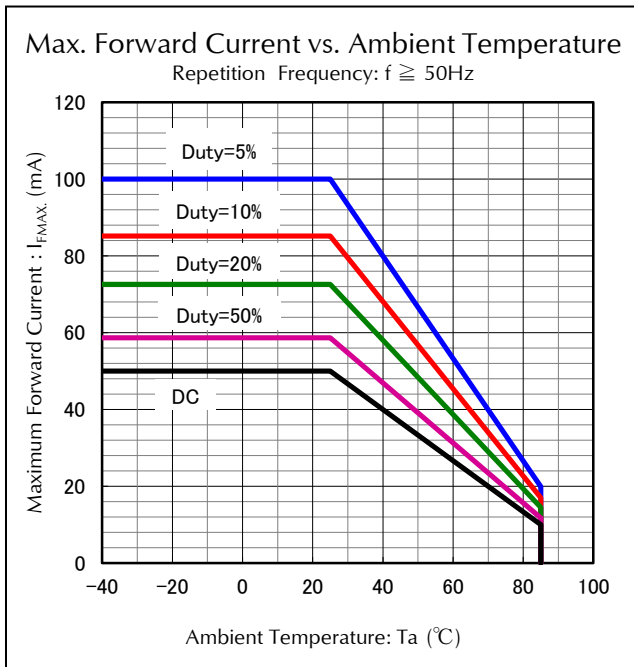
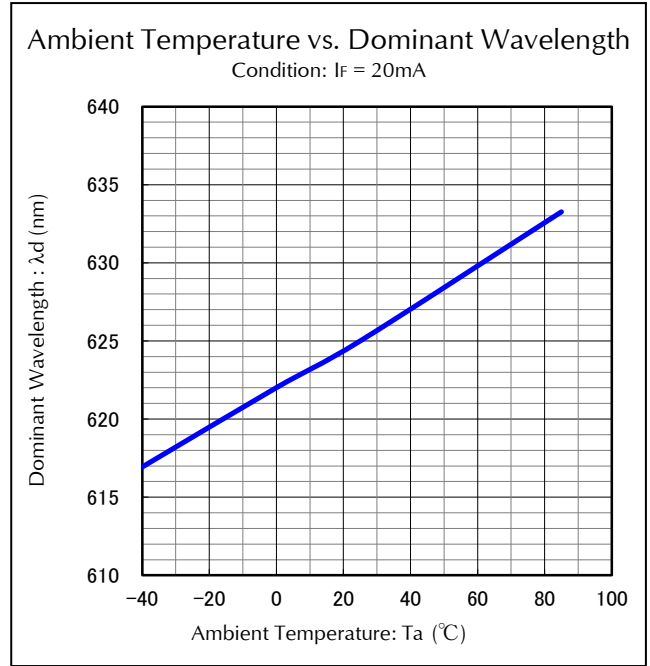
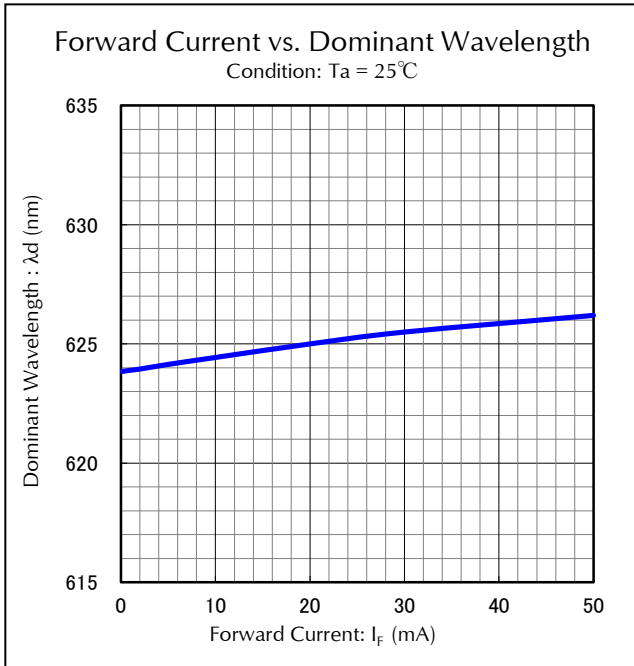



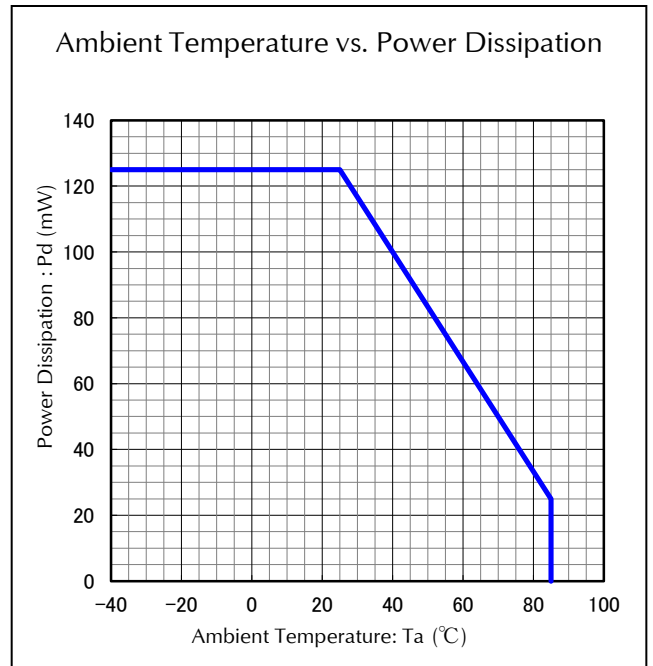
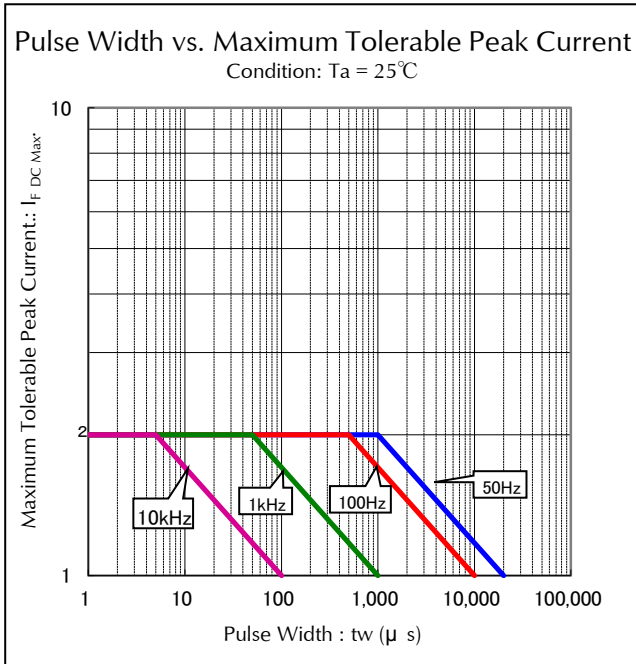

# Soldering Conditions

FKR3C64X-H

## 1 Soldering Precaution

- 1) Please avoid dipping the resin directly into the solder bath.
- 2) Please do not apply the heat of 100 °C or more to the resin.
- 3) Any shock or vibration to the LED resin body should be avoided after soldering for the resin is soft and easily to be damaged until it return to room temperature.
- 4) Heating up for temporarily fix of other surface-mounting device should be done under 100°C. Avoid any pressure to the frame and resin part of LED.
- 5) The tie-bar cutting part might get oxidized because iron has been exposed. Please avoid soldering on the tie-bar part, because the solderability decreases when oxidization occurs. When the soldering part and die-bar cutting part overlaps, please confirm the solderability before using.

## 2 Recommendation Condition of Soldering

### 1) Soldering iron

Temperature at tip of iron : 400°C MAX.

Soldering time : 3s MAX.

※Position : At least 1.6mm away from the root of lead

The number of manual soldering process shall be 2 times Max.

Cooling process to room temp. is required between first and second manual soldering process.

### 2) Dip Soldering

Pre-heating : Resin surface temperature should be set under 100°C.

Bath temperature : 265°C MAX.

Dipping time : 5s MAX.

※Position : At least 1.6mm away from the root of lead.

The number of dip soldering process shall be 2 times Max.

Cooling process to room temp. is required between first and second dip soldering process.

※Soldering positioning

Note Through hole board is not recommended because soldering position will become 0 mm.

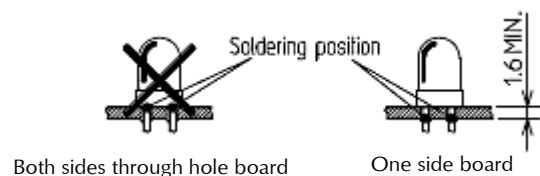

### 3) Reflow Soldering

Not recommended

(However, if LED lamp and other electronic components are soldered together and the temperature of resin can be controlled within 100°C, reflow soldering is acceptable.)

## 【 1. Cleaning 】

- 1) Some chemicals could corrode, oxidize cloud or crack the optical characteristics of the lens.  
Please review the reference chat below carefully before cleaning.

Solvent	Adaptability
Isopropyl alcohol	○
Pure water	○
Acetone	×
Thinner	×

NOTE   •Dipping time: 3 minutes MAX.(at room temperature)  
          •If pure water is used, please refer to 4).

- 2) Effect of ultrasonic cleaning on the LED will vary on such factors as the oscillator output, capacity ,size of P.C.B and LED mounting method, etc.  
Cleaning should be done after confirming that there is no problem during actual usage with ultrasonic cleaning .
- 3) Freon substitute detergent could corrode, oxidize, cloud or crack the resin of LED, please ensure that there is no problem before using it.
- Freon substitute detergent
- Clean through-750H
  - Pine alpha ST-100S
- 4) If water needs to be used for cleaning, please use pure water(not tap water), and completely dry the component.

## 【 2. Lead Forming 】

- 1) The lead frame should be bent at a point 1.6mm away from the root of lead.  
Please perform at room temperature.
- 2) During forming, a jig or radio pliers should be firmly fixed to the root of lead, to which no mechanical stress should be applied.
- 3) All forming must be performed prior to soldering.
- 4) Forming pitch should be adjusted to the device insertion hole-pitch on the PCB.
- 5) Please avoid bending at the tie-bar part of lead during foaming because there is possibility that the stable forming shape can not be formed.

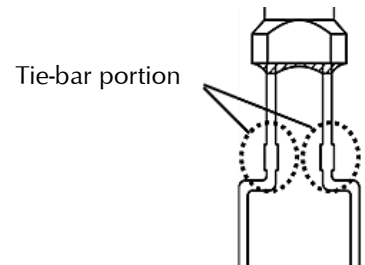

## 【 3. LED Mounting method 】

- 1) Please avoid excessive stress to lead frames during mounting. Mounting should be performed at room temperature.
- 2) To determine mount positions of LEDs using a case, please take into account the dimensions of the casing, board, device to avoid excessive stress on the lead.
- 3) Please fix the LED within the casing using the lead, and do not use adhesives, resin, or any other materials to fix the LED position.
- 4) With regard to using an inserter (automation), please adjust the insertion pressure to the lowest possible setting, and minimize the clinch angle as for as it can hold the component.

<ex.> Clinch angle : Cathode 15° MIN.  
Anode 45° MIN.

Pusher pressure : 0.2MPa MAX.

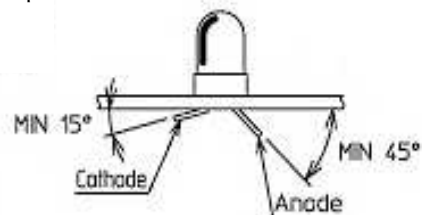

Lead width	Holes between pitches on board
0.4mm	φ0.7~1.0mm

## 【 Basic design 】

### 1.1 Designing for Safety

All LED Lamps are designed to operate without failure in recommended usage conditions. However, all semiconductor components are prone to unexpected malfunctions and failures. Please take the necessary precautions to prevent fire, injury and other damage should any malfunction or failure arise.

### 1.2 Absolute Maximum Rating

Absolute Maximum Ratings are set to prevent LED Lamps from failing due to excess stress (temperature, current, voltage, etc.). Usage conditions must not exceed the ratings for a moment, nor do reach one items of Absolute Maximum Rating simultaneously.

### 1.3 Actual Usage Design

- 1) In order to ensure high reliability from LED lamps, variable factors that arise in actual usage conditions should be taken in account for designing.( Derating of TYP., MAX Forward Voltage, etc.)
- 2) Please insert straight protective resistors into the circuit in order to stabilize LED lamp operation and also to prevent the device from igniting due to excess current. If LEDs need to be used in a matrix circuit, a fully understanding of LEDs' characteristics is required for designing..
- 3) This LED lamps should be used with current of 2mA or more. If using LED lamps with current over 2 mA, it might vary considerably in chromaticity, luminous intensity, forward current. So current of 2mA or more is recommended considering the optimization of product selection and protective resistors.

## 【 The others 】

- 1) Once the package is open, please use as soon as possible, as keeping an opened package for a long time could cause the lead frame to oxidize. For storage, please avoid wetness and humidity, while taking care to avoid condensation caused by rapid temperature changes.
- 2) In case of product failures, the lot number on the product package label will be helpful in speeding up our response action.
- 3) Please refrain from looking directly at the light source of LED Lamp at high output, as it may harm your vision.
- 4) Stanley LED Lamps have semiconductor characteristics and are designed to ensure high reliability. However, the performance may vary depending on usage conditions
- 5) Please check the actual performance in the assembly because the Specification Sheets are described for single LED.
- 6) The products are manufactured to be used for ordinary electronic equipment. Please contact our sales staff beforehand when exceptional quality and reliability are required, and the failure or malfunction of the products might directly jeopardize life or health ( such as for airplanes, aerospace, transport equipment, medical applications, nuclear reactor control systems and so on).
- 7) If the actual using condition is different from Stanley's recommended conditions on this specification, please verify LED lamp's performance under actual conditions to ensure there is no problem before actual use.
- 8) The formal specification sheets shall be valid only by exchange of documents signed by both parties.

# Packaging Specifications

FKR3C64X-H

## 【 Package 】

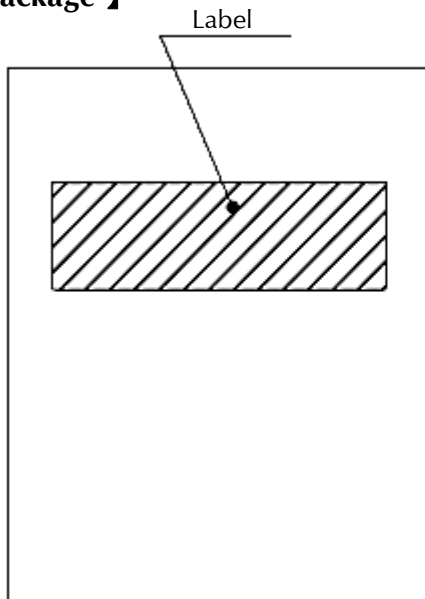

Front side

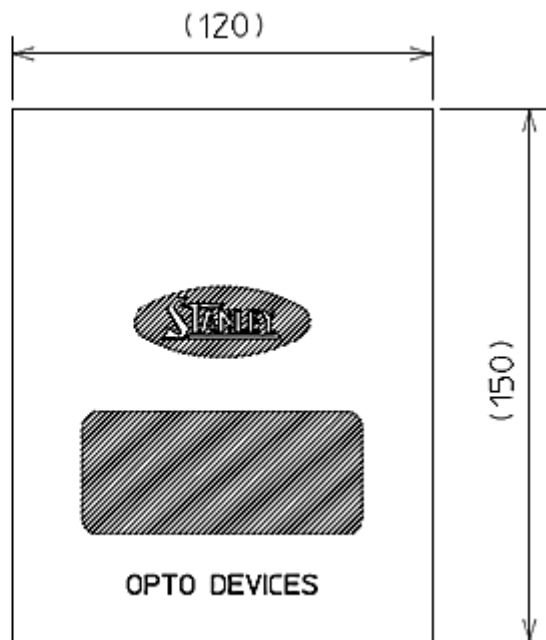

Back side

## 【 Label Specification 】

[acc.to JIS-X0503(Code-39)]

### Product label

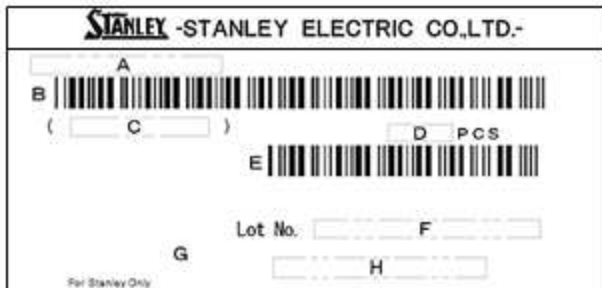

- A. Parts number
- B. Bar-code for parts number
- C. Parts code (In-house identification code for each parts number)
- D. Packed parts quantity
- E. Bar-Code for packed parts quantity
- F. Lot number & Rank  
(refer to Lot Number Notational System for details )
- G. QR-Code for internal management
- ★ H. Customer Parts number

Note "★" only appears when customer parts number is different form Stanley parts number.



## Packaging Specifications

---

### 【 Package 】

1. Package conditions: Clear plastic bag , 200pcs. / bag.
2. Warranty period: Within 12 months under following conditions.  
Un-opened, at normal temperature / Normal relative humidity ( +5~+30°C / 70%Rh.max. ).

#### Note1

The solderability of terminals of LED might decrease if above warranty period expired.

#### Note2

Terminals of LED might get oxidized which will decrease the solderability of terminals if the products are stored with cardboard and rubber. The products should be isolated from these in keeping.

#### Note3

Due to convenience of shipping and transportation, Stanley use cardboard box to shipping products during transportation. Cardboard contains sulfur element which will corrode silver plating. Please take the products out of the cardboard box for long term storage.

#### Note4

Excess press to the package bag which might deform the lead part of LEDs should be avoided.

# Packaging Specifications

## FKR3C64X-H

### 3. Inner Packing Box.

Box Type	Outline dimension L × W × H ( mm )	Box Type	Outline dimension L × W × H ( mm )
A1	195 × 117 × 38	B2	310 × 225 × 105
A4	304 × 224 × 46	B3	495 × 230 × 150
HEAD	390 × 210 × 65		

- Note
- The above measures are all reference values.
  - The box is selected out of the above table by shipping quantity and product size.
  - Package materials are filled into the box to keep products from moving.

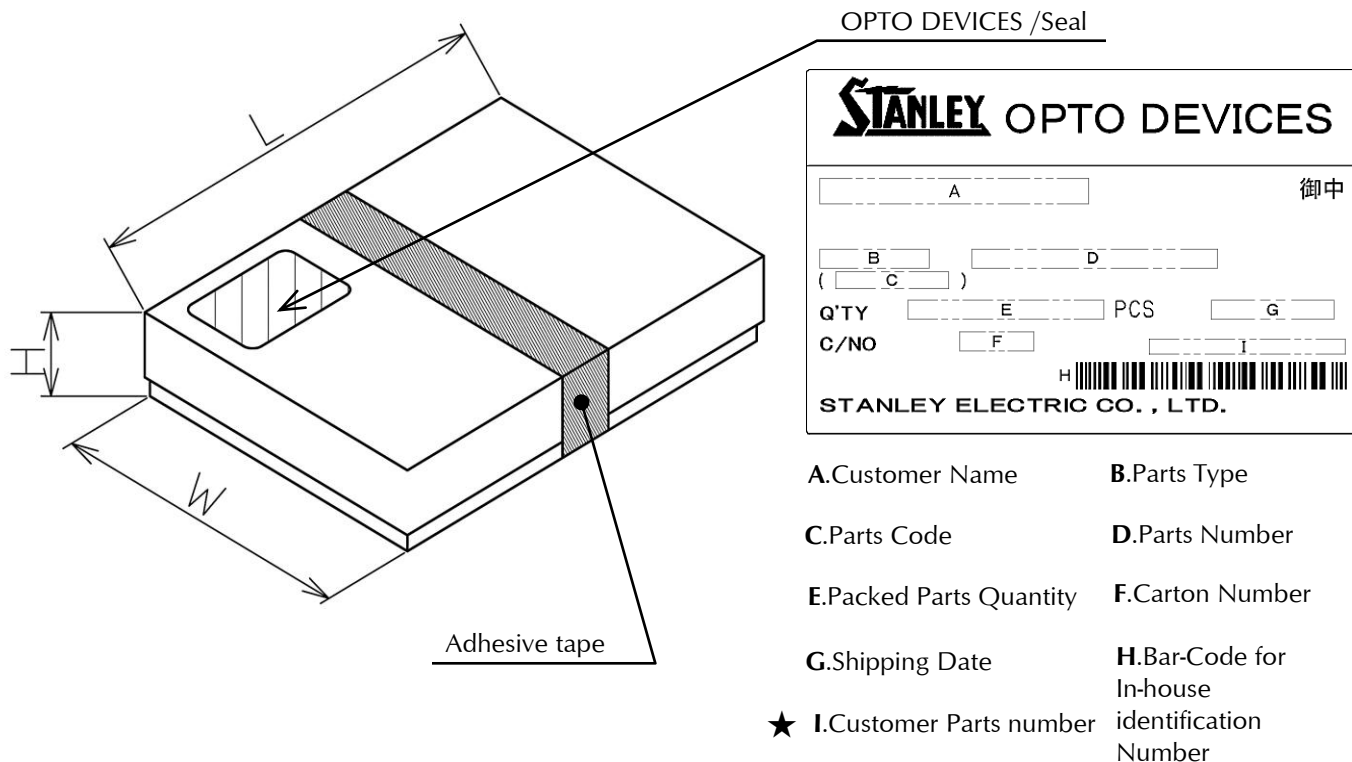

- Notes
- The above figure is a representative example. The way that how adhesive tape is applied differs by the box type.
  - "★" only appears when customer parts number is different from Stanley parts number.

# Packaging Specifications

FKR3C64X-H

## 4. Outer packing box.

Box Type	Outline dimension L × W × H ( mm )	Box Type	Outline dimension L × W × H ( mm )
HEAD	390 × 210 × 65	G1	480 × 340 × 225
G4	320 × 230 × 150	LED-C	505 × 255 × 315
2P	410 × 150 × 230	G2	480 × 340 × 320
SH-1	510 × 255 × 165	10P	400 × 335 × 450
5P	400 × 335 × 225		

- Note
- The above measure are all reference value.
  - The box is selected out of the above table by shipping quantity and product size.
  - Package materials are filled into the box to keep products form moving

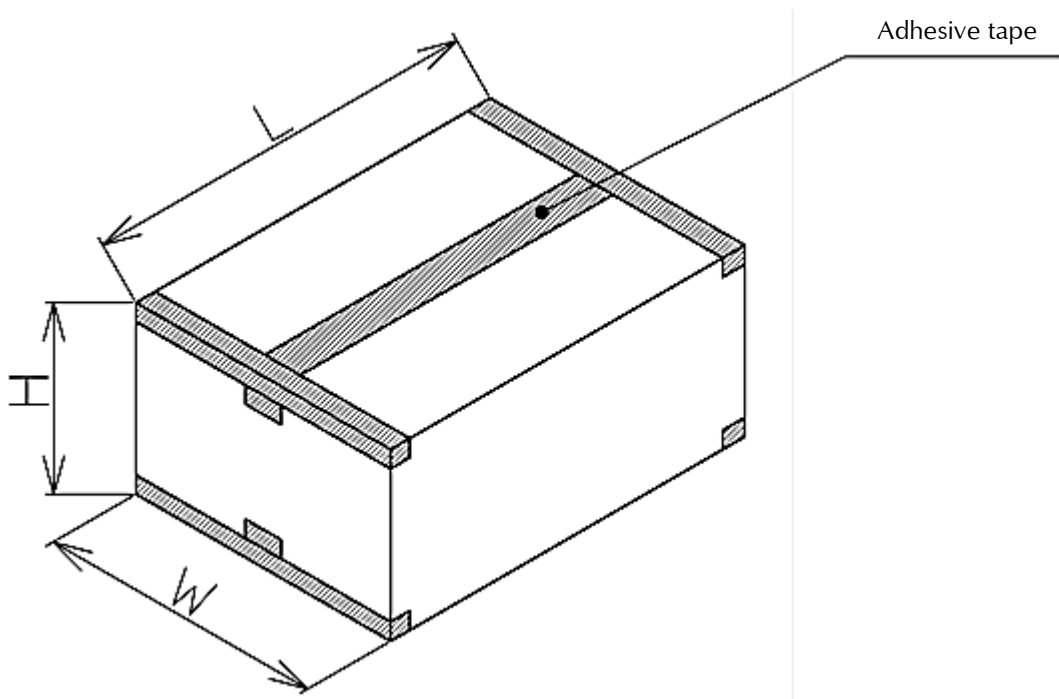

- Note a. The above figure is a representative example. The way that how adhesive tape is applied on the box differs by the box type.

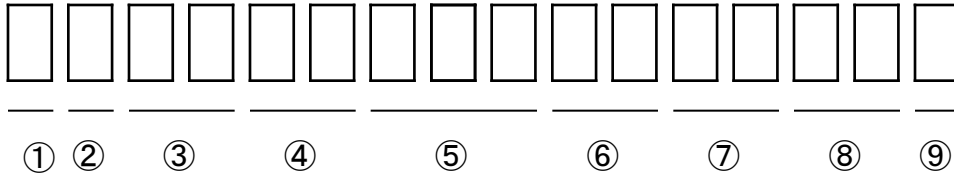

① - 1digit : Production Location (Mark identify alphabet)

② - 1digit : Production Year (Last digit of Production Year 2009→9,2010→0,2011→1,···)

③ - 2digit : Production Month (Jan. to Sep. , should be 01,02,03,·····)

④ - 2digit : Production Date

⑤ - 3digit : Serial Number

⑥ - 2digit : Tape and Reel following Number

⑦ - 2digit : Luminous Intensity Rank.

(If luminous intensity rank is 1 digit, "-" shall be dashed on the place for the second digit.  
If there is no identified intensity rank, "- ." is used to indicate.)

⑧ - 2digit : Chromaticity Rank

(If chromaticity rank is 1 digit, "-" shall be dashed on the place for the second digit.  
If there is no identified intensity rank, "- ." is used to indicate.)

⑨ - 1digit : Option Rank (Stanley normally print "-" to indicate)

# Correspondence to RoHS•ELV instruction

FKR3C64X-H

This product is in compliance with RoHS•ELV.

Prohibition substance and it's criteria value of RoHS•ELV are as follows.

- RoHS instruction ..... Refer to following (1)~(6).
- ELV instruction ..... Refer to following (1)~(4).

	Substance Group Name	Criteria Value
(1)	Lead and its compounds	1,000ppm Max
(2)	Cadmium and its compounds	100ppm Max
(3)	Mercury and its compounds	1,000ppm Max
(4)	Hexavalent chromium	1,000ppm Max
(5)	PBB	1,000ppm Max
(6)	PBDE	1,000ppm Max

# Reliability Testing Result

FKR3C64X-H

## 1. Reliability Testing Result

Testing Items	Applicable Standard	Testing Conditions
Room Temp. Operating Life	EIAJ ED-4701/100(101)	Ta = 25°C, I <sub>F</sub> = Maximum Rated Current, t = 1,000h
Resistance to Soldering Heat	EIAJ ED-4701/300(302)	260 ± 5°C, 10s, 3mm from package base
Temperature Cycling	EIAJ ED-4701/100(105)	Minimum Rated Storage Temp.(30min) ~ Normal Temp.(15min) ~ Maximum Rated Storage Temp.(30min) ~ Normal Temp.(15min) 5 cycles
Wet High Temp. Storage Life	EIAJ ED-4701/100(103)	Ta = 60±2°C, RH = 90±5%, t = 1,000h
High Temp. Storage Life	EIAJ ED-4701/200(201)	Ta = Maximum Rated Storage Temp.
Low Temp. Storage Life	EIAJ ED-4701/200(202)	Ta = Minimum Rated Storage Temp.
Lead Tension	EIAJ ED-4701/400(401)	10N, 10s, 1time
Vibration, Variable Frequency	EIAJ ED-4701/400(403)	98.1m/s <sup>2</sup> (10G), 100 ~ 2KHz sweep for 20min., XYZ each direction, 2h of each direction

## 2. Failure Criteria

Items	Symbol	Conditions	Failure criteria
Luminous Intensity	I <sub>V</sub>	Ta=25°C I <sub>F</sub> =20mA	Testing Min. Value < Spec. Min. Value x 0.5
Forward Voltage	V <sub>F</sub>	Ta=25°C I <sub>F</sub> =20mA	Testing Max. Value ≥ Spec. Max. Value x 1.2
Reverse Current	I <sub>R</sub>	Ta=25°C V <sub>R</sub> =4V	Testing Max. Value ≥ Spec. Max. Value x 2.5
Cosmetic Appearance	-	-	Occurrence of notable decoloration, deformation and cracking



## Special Notice to Customers Using the Products and Technical Information Shown in This Data Sheet

- 1) The technical information shown in the data sheets are limited to the typical characteristics and circuit examples of the referenced products. It does not constitute the warranting of industrial property nor the granting of any license.
- 2) For the purpose of product improvement, the specifications, characteristics and technical data described in the data sheets are subject to change without prior notice. Therefore it is recommended that the most updated specifications be used in your design.
- 3) When using the products described in the data sheets, please adhere to the maximum ratings for operating voltage, heat dissipation characteristics, and other precautions for use. We are not responsible for any damage which may occur if these specifications are exceeded.
- 4) The products that have been described to this catalog are manufactured so that they will be used for the electrical instrument of the benchmark (OA equipment, telecommunications equipment, AV machine, home appliance and measuring instrument).  
The application of aircrafts, space borne application, transportation equipment, medical equipment and nuclear power control equipment, etc. needs a high reliability and safety, and the breakdown and the wrong operation might influence the life or the human body. Please consult us beforehand if you plan to use our product for the usages of aircrafts, space borne application, transportation equipment, medical equipment and nuclear power control equipment, etc. except OA equipment, telecommunications equipment, AV machine, home appliance and measuring instrument.
- 5) In order to export the products or technologies described in this data sheet which are under the "Foreign Exchange and Foreign Trade Control Law," it is necessary to first obtain an export permit from the Japanese government.
- 6) No part of this data sheet may be reprinted or reproduced without prior written permission from Stanley Electric Co., Ltd.
- 7) The most updated edition of this data sheet can be obtained from the address below:  
<http://www.stanley-components.com/en/>