



Chipsmall Limited consists of a professional team with an average of over 10 year of expertise in the distribution of electronic components. Based in Hongkong, we have already established firm and mutual-benefit business relationships with customers from,Europe,America and south Asia,supplying obsolete and hard-to-find components to meet their specific needs.

With the principle of “Quality Parts,Customers Priority,Honest Operation,and Considerate Service”,our business mainly focus on the distribution of electronic components. Line cards we deal with include Microchip,ALPS,ROHM,Xilinx,Pulse,ON,Everlight and Freescale. Main products comprise IC,Modules,Potentiometer,IC Socket,Relay,Connector.Our parts cover such applications as commercial,industrial, and automotives areas.

We are looking forward to setting up business relationship with you and hope to provide you with the best service and solution. Let us make a better world for our industry!



Contact us

Tel: +86-755-8981 8866 Fax: +86-755-8427 6832

Email & Skype: info@chipsmall.com Web: www.chipsmall.com

Address: A1208, Overseas Decoration Building, #122 Zhenhua RD., Futian, Shenzhen, China





FL6L52070L

Silicon P-channel MOSFET(FET)
Silicon epitaxial planar type(SBD)

For switching
For DC-DC Converter

■ Features

- Low drain-source ON resistance : $R_{DS(on)}$ typ. = 300 m Ω ($V_{GS} = -4.0$ V)
- Low drive voltage : 2.5 V drive
- Halogen-free / RoHS compliant
(EU RoHS / UL-94 V-0 / MSL:Level 1 compliant)

■ Marking Symbol Y4

■ Packaging

Embossed type (Thermo-compression sealing) 10 000 pcs / reel (standard)

■ Absolute Maximum Ratings $T_a = 25$ °C

項目		Symbol	Rating	Unit
FET	Drain to Source Voltage	VDS	-20	V
	Gate to Source Voltage	VGS	±12	V
	Drain current	ID	-1.0	A
	Peak drain current	IDp	-4.0	A
	Channel temperature	Tch	150	°C
SBD	Reverse voltage	VR	20	V
	Forward current (Average)	IF(AV)	700	mA
	Junction temperature	Tj	125	°C
Overall	Total power dissipation ^{*1}	PD	540	mW
	Operating ambient temperature	Topr	-40 to +85	°C
	Storage temperature	Tstg	-55 to +125	°C

Note: *1 Glass epoxy board (25.4 x 25.4 x t0.8 mm) coated with copper foil, which has more than 300mm².
PD absolute maximum rating without a heat sink: 150 mW

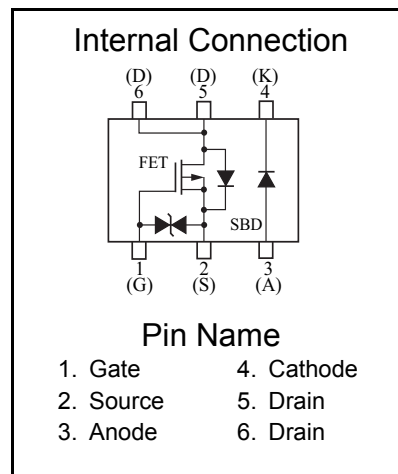
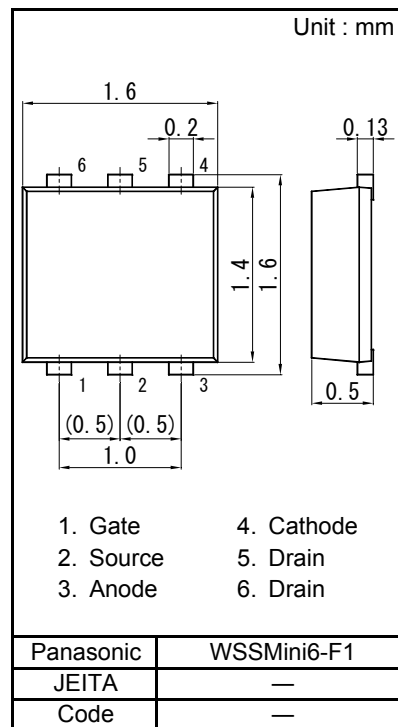

■ Electrical Characteristics Ta = 25 °C ± 3 °C
 FET (P-ch.)

Parameter	Symbol	Conditions	Min	Typ	Max	Unit
Drain-source surrender voltage	VDSS	ID = -1.0 mA, VGS = 0 V	-20			V
Drain-source cutoff current	IDSS	VDS = -20 V, VGS = 0 V			-1.0	μA
Gate-source cutoff current	IGSS	VGS = ±10 V, VDS = 0 V			±10	μA
Gate threshold voltage	VTH	ID = -1.0 mA, VDS = -10 V	-0.45	-1.0	-1.5	V
Drain-source ON resistance *1	RDS(on)1	ID = -0.5 A, VGS = -4.0 V		300	420	mΩ
	RDS(on)2	ID = -0.5 A, VGS = -2.5 V		420	560	
Forward transfer admittance *1	Yfs	ID = -0.5 A, VDS = -10 V, f = 1 kHz	1.0			S
Short-circuit input capacitance (Common source)	Ciss	VDS = -10 V, VGS = 0 V, f = 1 MHz		80		pF
Short-circuit output capacitance (Common source)	Coss			12		
Reverse transfer capacitance (Common source)	Crss			12		
Turn-on delay time *2	td(on)	VDD = -15 V, VGS = 0 to -4.0 V		12		ns
Rise time *2	tr	ID = -0.5 A		6		
Turn-off delay time *2	td(off)	VDD = -15 V, VGS = -4.0 to 0 V		17		ns
Fall time *2	tf	ID = -0.5 A		10		

Note: 1. Measuring methods are based on JAPANESE INDUSTRIAL STANDARD JIS C 7030 Measuring methods for transistors.

2. *1 Pulse measurement

*2 Measurement circuit for Turn-on Delay Time/Rise Time/Turn-off Delay Time/Fall Time

SBD

Parameter	Symbol	Conditions	Min	Typ	Max	Unit
Forward voltage	VF1	IF = 10 mA			0.4	V
	VF2	IF = 500 mA			0.55	
Reverse current	IR1	VR = 5 V			1	μA
	IR2	VR = 10 V			10	

Note: Measuring methods are based on JAPANESE INDUSTRIAL STANDARD JIS C 7031 Measuring methods for diodes.

*2 Measurement circuit for Turn-on Delay Time/Rise Time/Turn-off Delay Time/Fall Time

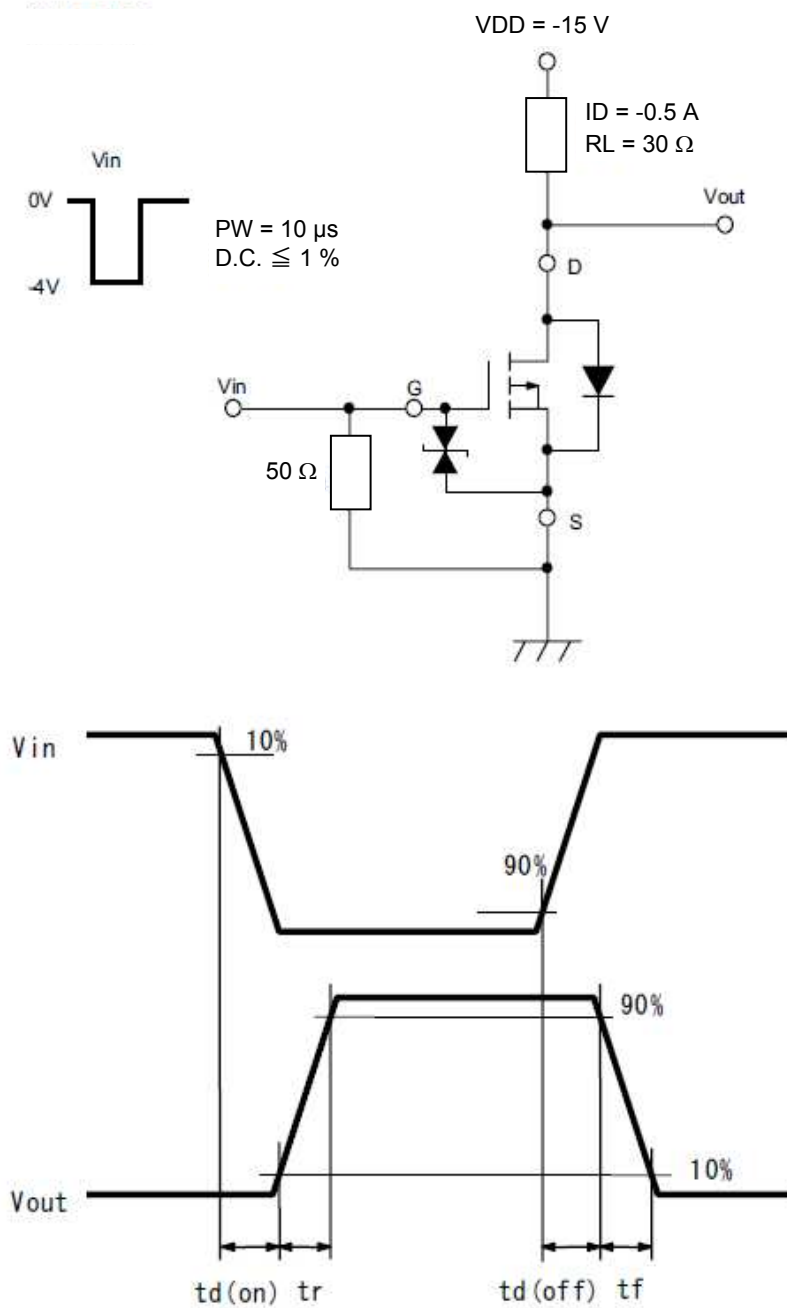



Technical Data (reference)

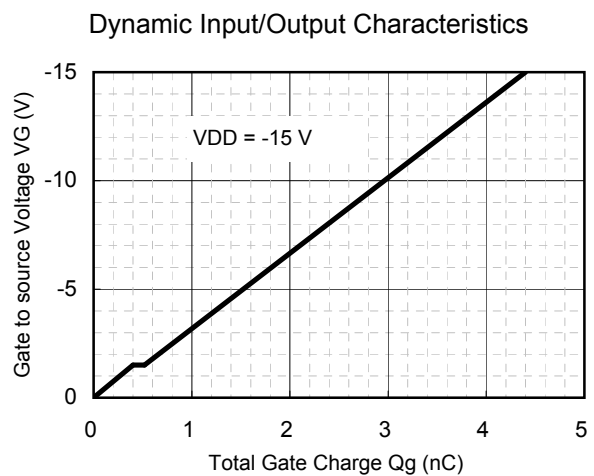
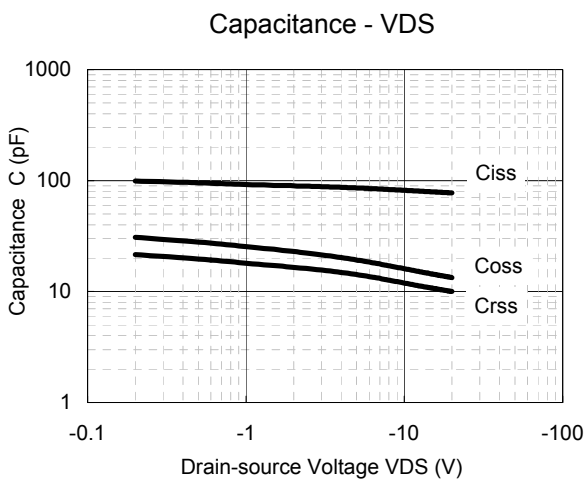
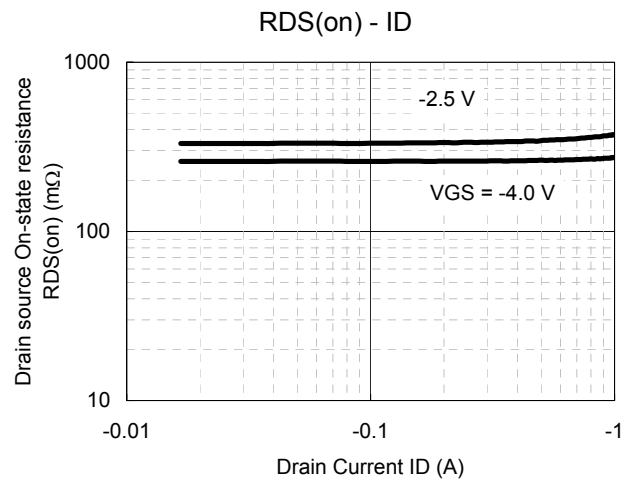
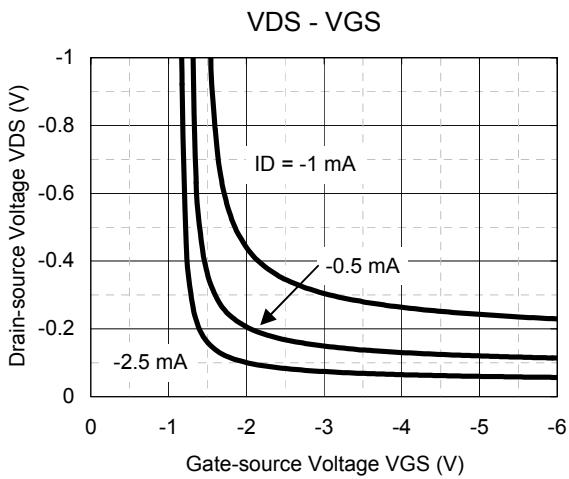
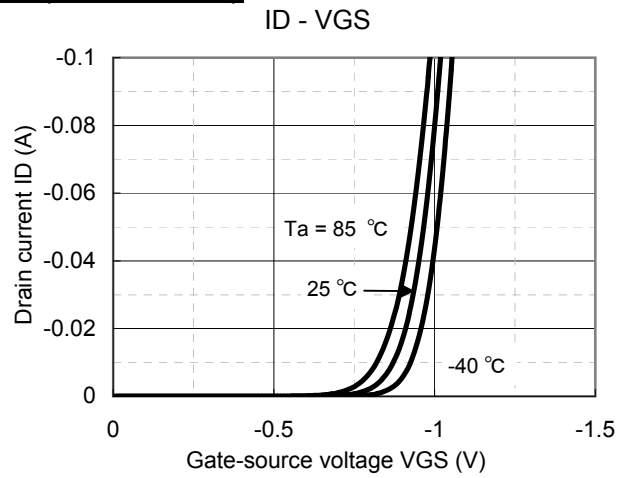
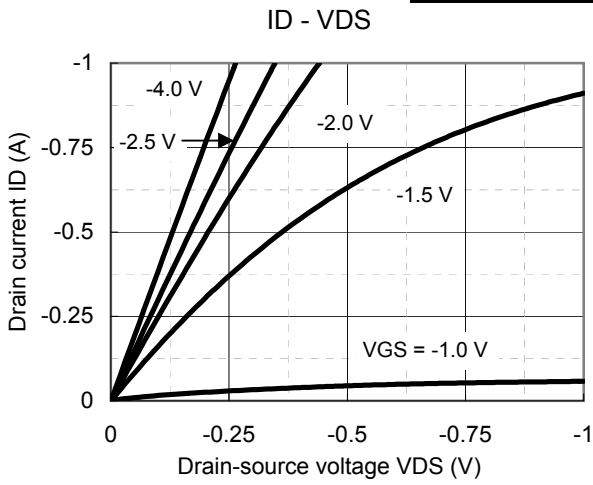

Technical Data (reference)

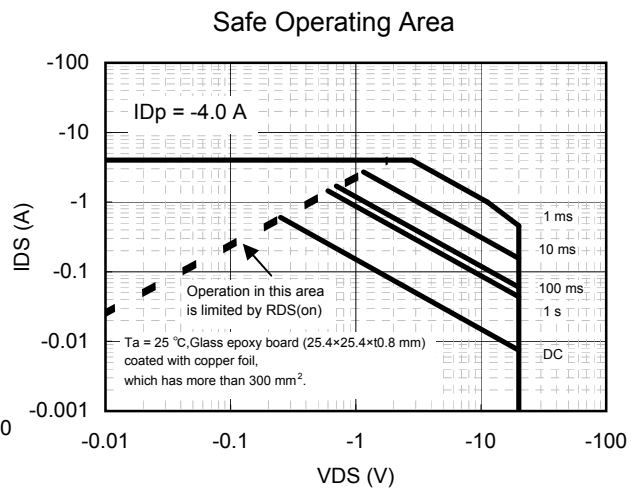
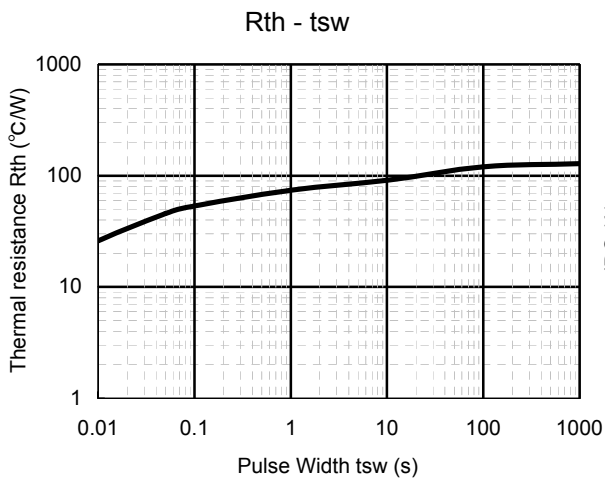
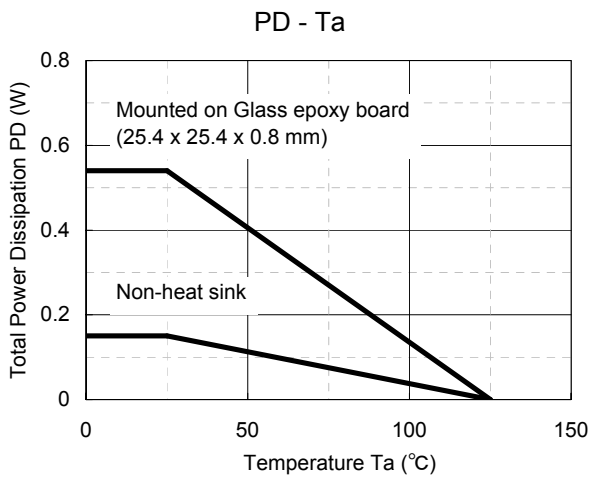
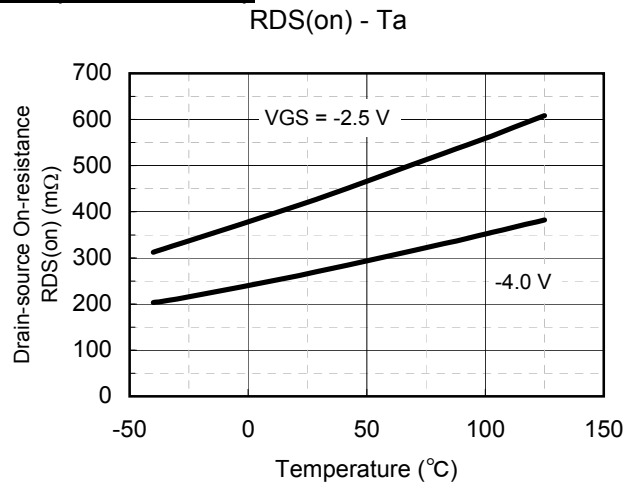
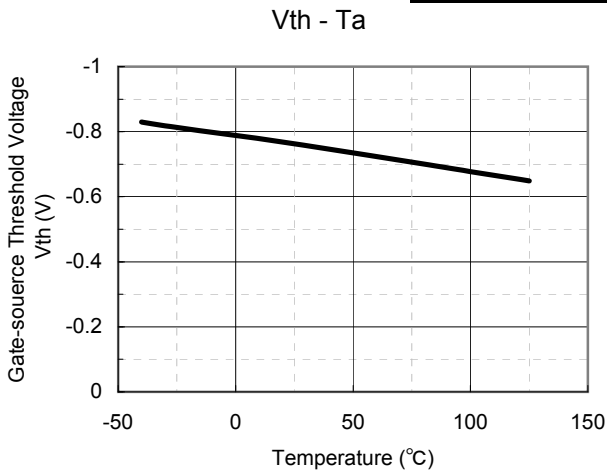

WSSMini6-F1

Unit: mm

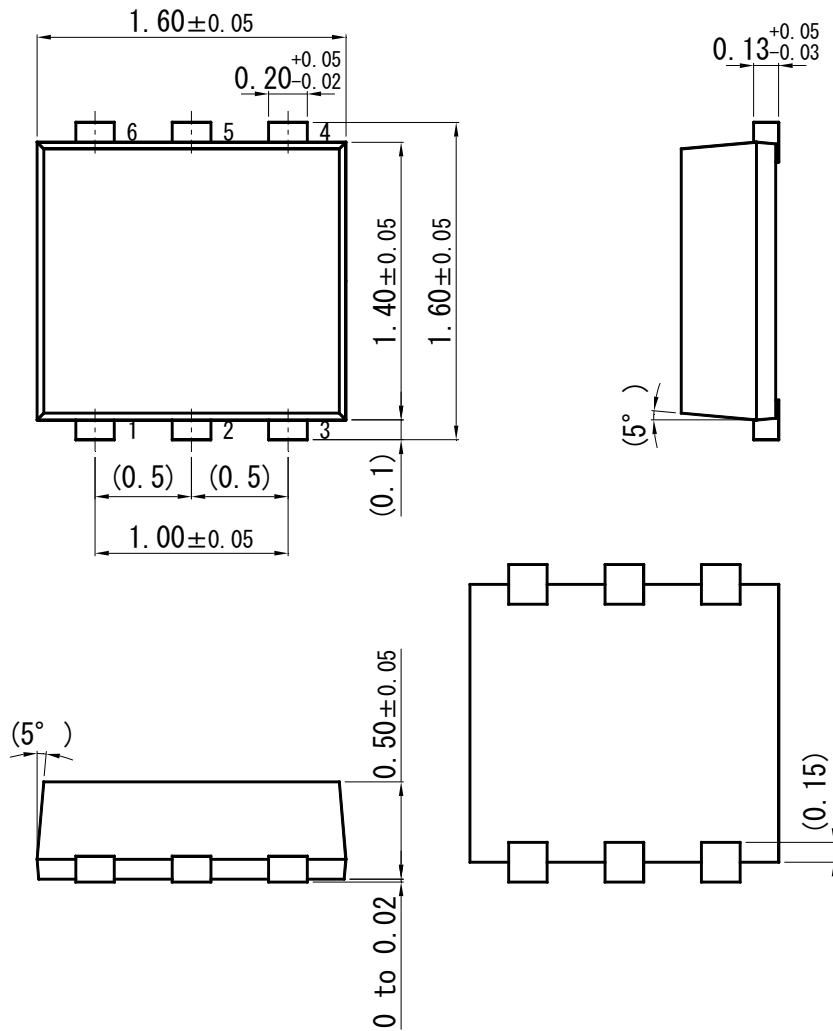

■ Land Pattern (Reference) (Unit : mm)

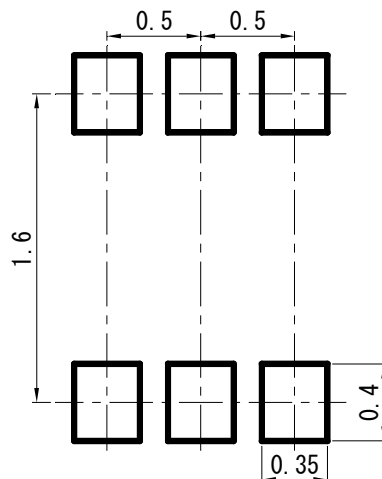

Request for your special attention and precautions in using the technical information and semiconductors described in this book

- (1) If any of the products or technical information described in this book is to be exported or provided to non-residents, the laws and regulations of the exporting country, especially, those with regard to security export control, must be observed.
- (2) The technical information described in this book is intended only to show the main characteristics and application circuit examples of the products. No license is granted in and to any intellectual property right or other right owned by Panasonic Corporation or any other company. Therefore, no responsibility is assumed by our company as to the infringement upon any such right owned by any other company which may arise as a result of the use of technical information described in this book.
- (3) The products described in this book are intended to be used for general applications (such as office equipment, communications equipment, measuring instruments and household appliances), or for specific applications as expressly stated in this book.
Consult our sales staff in advance for information on the following applications:
 - Special applications (such as for airplanes, aerospace, automotive equipment, traffic signaling equipment, combustion equipment, life support systems and safety devices) in which exceptional quality and reliability are required, or if the failure or malfunction of the products may directly jeopardize life or harm the human body.It is to be understood that our company shall not be held responsible for any damage incurred as a result of or in connection with your using the products described in this book for any special application, unless our company agrees to your using the products in this book for any special application.
- (4) The products and product specifications described in this book are subject to change without notice for modification and/or improvement. At the final stage of your design, purchasing, or use of the products, therefore, ask for the most up-to-date Product Standards in advance to make sure that the latest specifications satisfy your requirements.
- (5) When designing your equipment, comply with the range of absolute maximum rating and the guaranteed operating conditions (operating power supply voltage and operating environment etc.). Especially, please be careful not to exceed the range of absolute maximum rating on the transient state, such as power-on, power-off and mode-switching. Otherwise, we will not be liable for any defect which may arise later in your equipment.
Even when the products are used within the guaranteed values, take into the consideration of incidence of break down and failure mode, possible to occur to semiconductor products. Measures on the systems such as redundant design, arresting the spread of fire or preventing glitch are recommended in order to prevent physical injury, fire, social damages, for example, by using the products.
- (6) Comply with the instructions for use in order to prevent breakdown and characteristics change due to external factors (ESD, EOS, thermal stress and mechanical stress) at the time of handling, mounting or at customer's process. When using products for which damp-proof packing is required, satisfy the conditions, such as shelf life and the elapsed time since first opening the packages.
- (7) This book may be not reprinted or reproduced whether wholly or partially, without the prior written permission of our company.