



Chipsmall Limited consists of a professional team with an average of over 10 year of expertise in the distribution of electronic components. Based in Hongkong, we have already established firm and mutual-benefit business relationships with customers from,Europe,America and south Asia,supplying obsolete and hard-to-find components to meet their specific needs.

With the principle of “Quality Parts,Customers Priority,Honest Operation,and Considerate Service”,our business mainly focus on the distribution of electronic components. Line cards we deal with include Microchip,ALPS,ROHM,Xilinx,Pulse,ON,Everlight and Freescale. Main products comprise IC,Modules,Potentiometer,IC Socket,Relay,Connector.Our parts cover such applications as commercial,industrial, and automotives areas.

We are looking forward to setting up business relationship with you and hope to provide you with the best service and solution. Let us make a better world for our industry!



Contact us

Tel: +86-755-8981 8866 Fax: +86-755-8427 6832

Email & Skype: info@chipsmall.com Web: www.chipsmall.com

Address: A1208, Overseas Decoration Building, #122 Zhenhua RD., Futian, Shenzhen, China



STEP 5

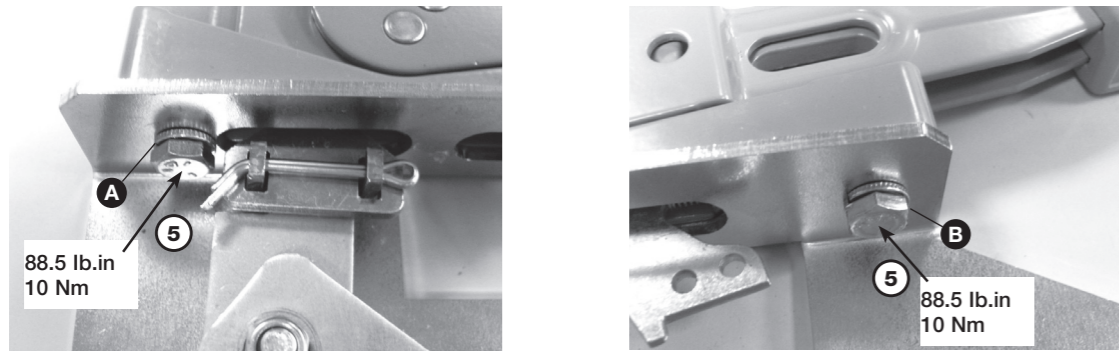
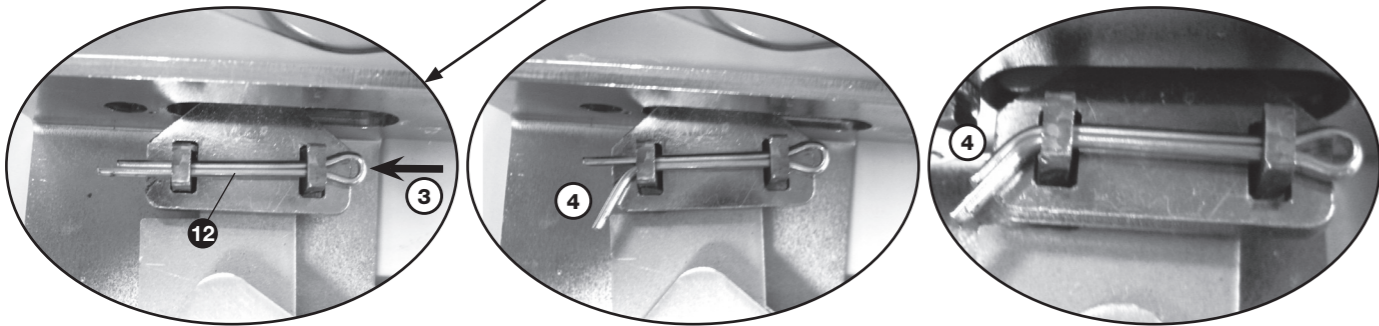
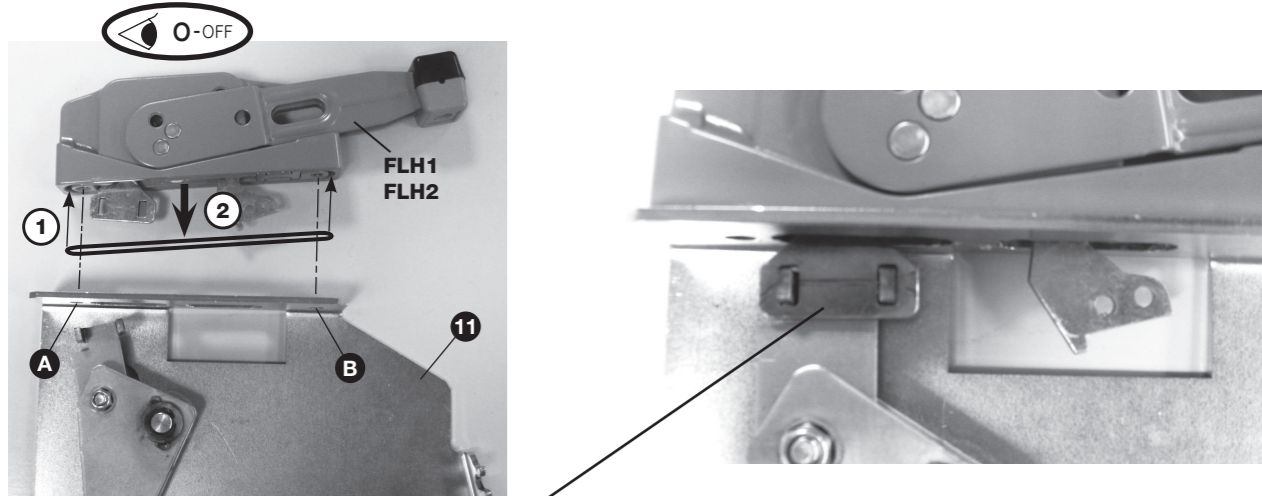

STEP 6

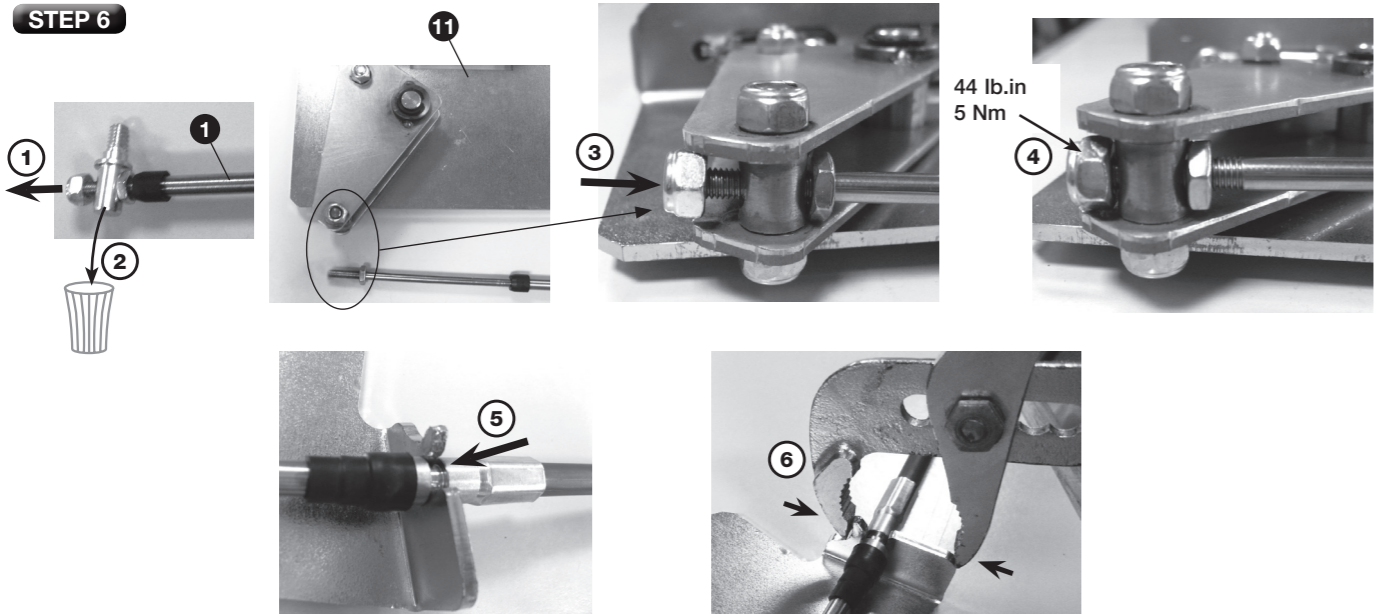

COOPER

Bussmann™

CABLE FLANGE FOR UL98 FUSIBLE DISCONNECT SWITCHES

⚠ DANGER / DANGER / PELIGRO

HAZARDOUS VOLTAGE

- This equipment must be installed and serviced only by qualified electrical personnel.
- Turn off all power supplying this equipment before working on or inside equipment.
- Always use a properly rated voltage sensing device to confirm power is OFF.
- Replace all devices, doors, and covers before turning on power to this equipment.
- Maintain electrical clearances between cable and live parts.

Failure to follow these instructions will result in death or serious injury.

TENSION DANGEREUSE

- L'installation et l'entretien de cet appareil ne doivent être effectués que par du personnel qualifié.
- Coupez l'alimentation de cet appareil avant d'y travailler.
- Utilisez toujours un dispositif de détection de tension à valeur nominale approprié pour confirmer que toute alimentation est coupée.
- Remplacez tous les dispositifs, les portes et les couvercles avant de mettre cet appareil sous tension.
- Maintenez les distances d'isolement électrique entre le câble et les pièces sous tension.

Si ces précautions ne sont pas respectées, cela entraînera la mort ou des blessures graves.

TENSION PELIGROSA

- Solamente el personal de mantenimiento eléctrico especializado deberá instalar y prestar servicios de mantenimiento a este equipo.
- Desenergice el equipo antes de realizar cualquier trabajo en él.
- Siempre utilice un dispositivo detector de tensión adecuado para confirmar la desenergización del equipo.
- Vuelva a colocar todos los dispositivos, las puertas y las cubiertas antes de energizar este equipo.
- Mantenga un espacio adecuado para la instalación eléctrica entre el cable y las piezas energizadas.

El incumplimiento de estas precauciones podrá causar la muerte o lesiones serias.

USED WITH
UTILISEES AVEC
UTILIZACIÓN CON

RDF30J-2	RDF60J-2-COMP	RDF60J-2	RDF100J-2	RDF200J-2
RDF30J-3	RDF60J-3-COMP	RDF60J-3	RDF100J-3	RDF200J-3
RDF30J-4	RDF60J-4-COMP	RDF60J-4	RDF100J-4	RDF200J-4

Dual dimensions in/mm
Double dimensions in/mm
Doble dimensiones in/mm

FLC36
FLC60
FLC120

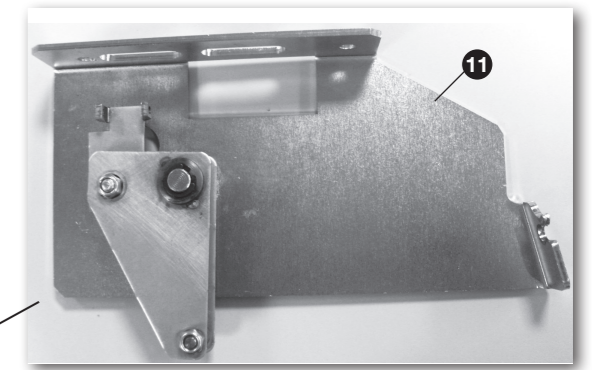

FLCM

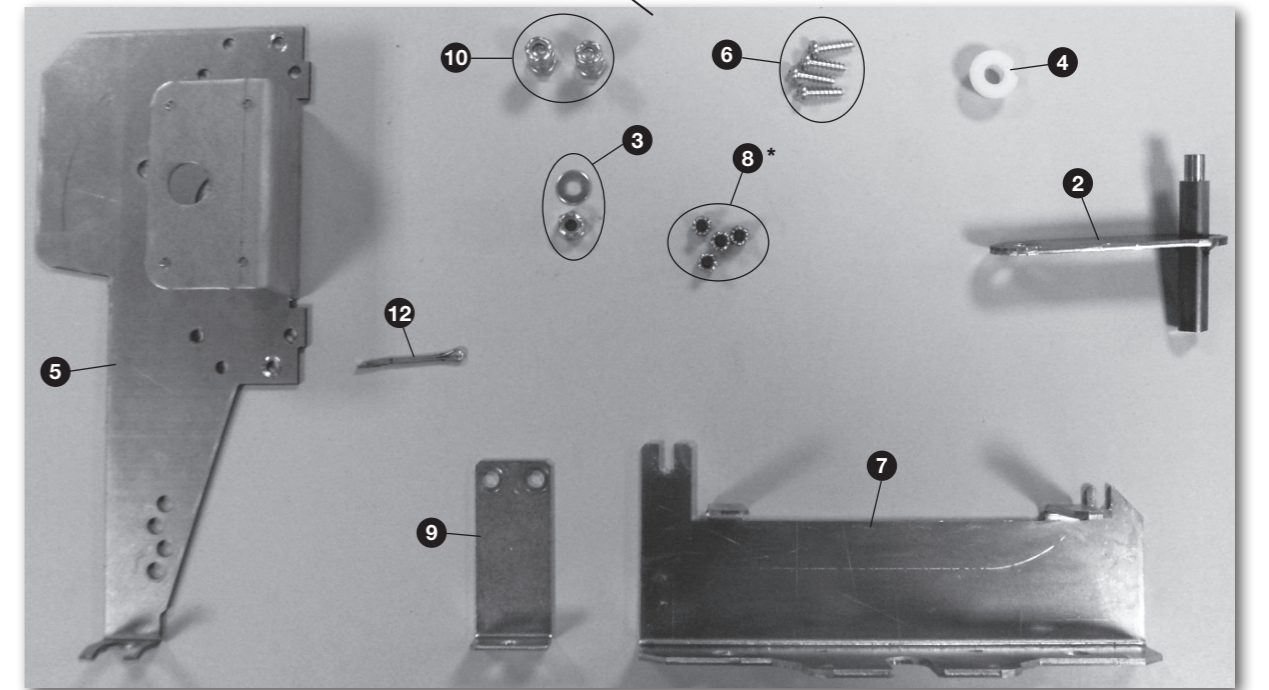

STEP 1

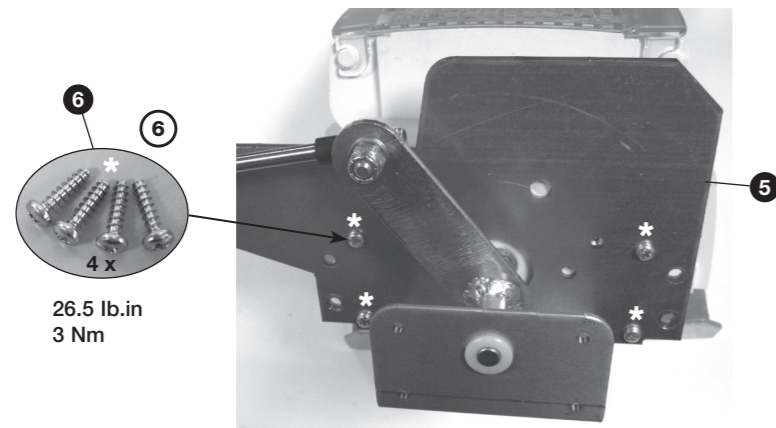
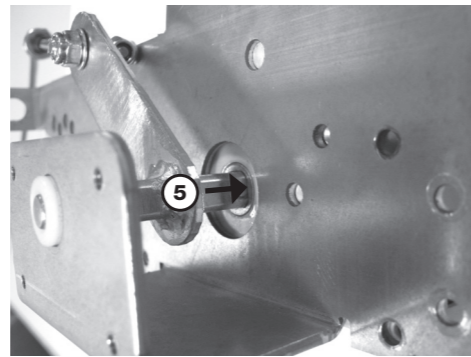
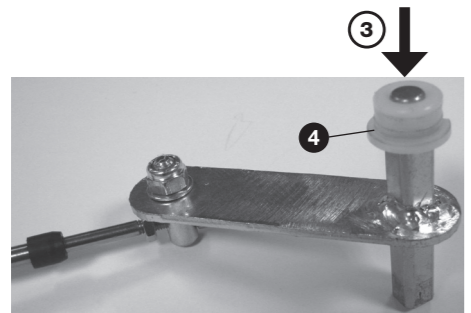
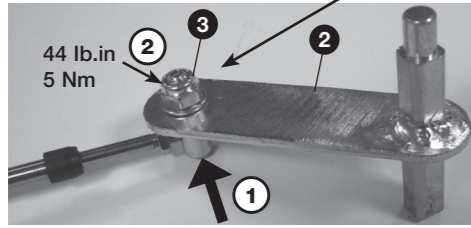
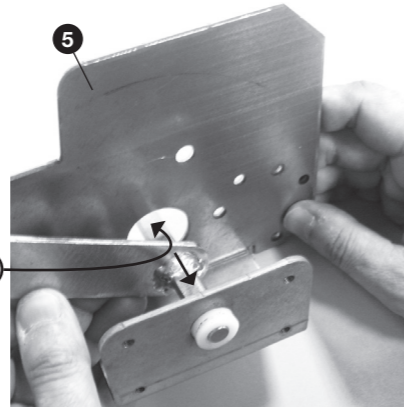
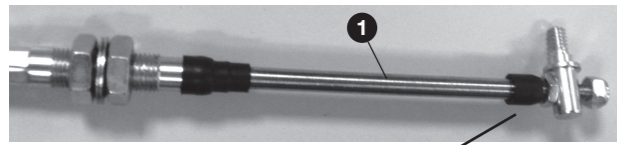

STEP 2

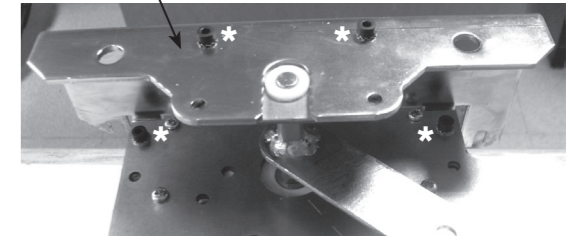
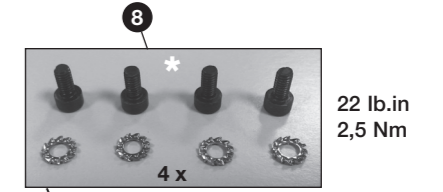
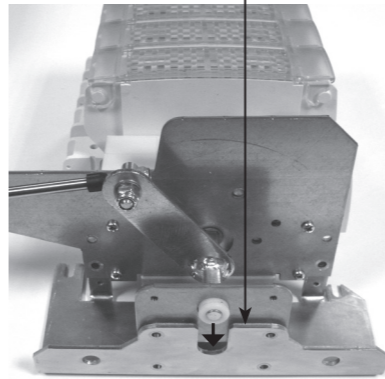
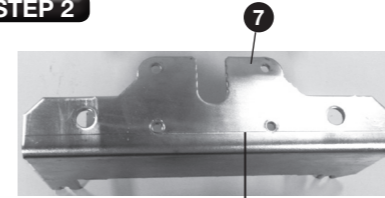

STEP 3

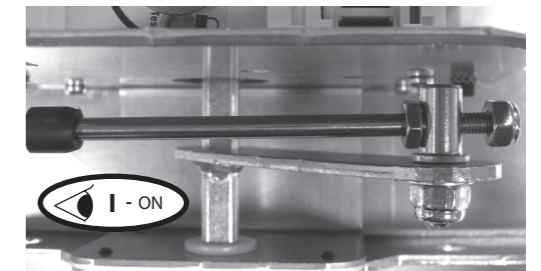
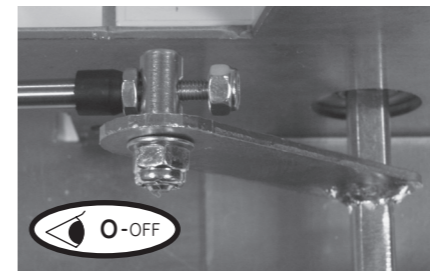
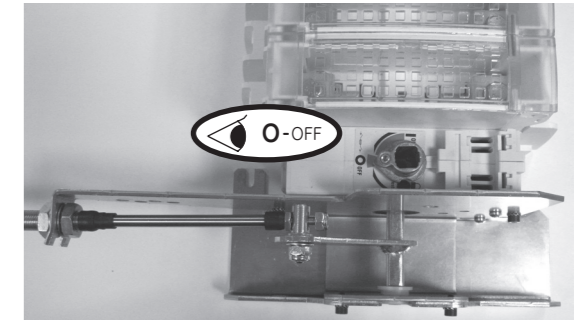
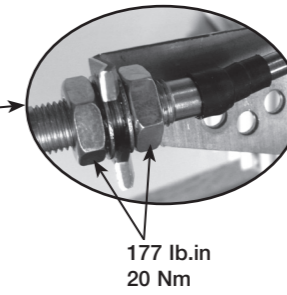
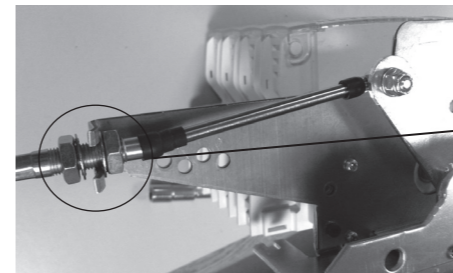

STEP 4

