



Chipsmall Limited consists of a professional team with an average of over 10 year of expertise in the distribution of electronic components. Based in Hongkong, we have already established firm and mutual-benefit business relationships with customers from,Europe,America and south Asia,supplying obsolete and hard-to-find components to meet their specific needs.

With the principle of "Quality Parts,Customers Priority,Honest Operation,and Considerate Service",our business mainly focus on the distribution of electronic components. Line cards we deal with include Microchip,ALPS,ROHM,Xilinx,Pulse,ON,Everlight and Freescale. Main products comprise IC,Modules,Potentiometer,IC Socket,Relay,Connector.Our parts cover such applications as commercial,industrial, and automotives areas.

We are looking forward to setting up business relationship with you and hope to provide you with the best service and solution. Let us make a better world for our industry!



## Contact us

Tel: +86-755-8981 8866 Fax: +86-755-8427 6832

Email & Skype: info@chipsmall.com Web: www.chipsmall.com

Address: A1208, Overseas Decoration Building, #122 Zhenhua RD., Futian, Shenzhen, China



THIS COPY IS PROVIDED ON A RESTRICTED BASIS AND IS NOT TO BE USED IN ANY WAY DETRIMENTAL TO THE INTERESTS OF PANDUIT CORP.

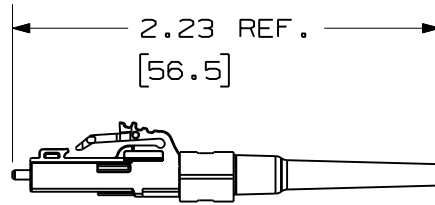

PANDUIT PART NUMBER	FIBER TYPE
FLCSMC5* <sup>1</sup> ** <sup>2</sup>	50/125um MULTIMODE
FLCSMC6* <sup>1</sup> ** <sup>2</sup>	62.5/125um MULTIMODE
FLCSMCX* <sup>1</sup> ** <sup>2</sup>	50/125um OM3 MULTIMODE
FLCSSC* <sup>1</sup> ** <sup>2</sup>	9/125um SINGLEMODE

\*<sup>1</sup> ALPHA KEY DESIGNATOR (SEE TABLE 2, SHEET 2)  
 \*\*<sup>2</sup> KEY COLOR DESIGNATOR (SEE TABLE 2, SHEET 2)

NOTES:

- SEE CATALOG FOR ADDITIONAL PART NUMBER SUFFIXES TO INDICATE COLOR AND/OR PACKAGE QUANTITY.
- ACCEPTS 50/125um, 62.5/125um, 50/125 OM3 MULTIMODE OR 9/125um SINGLEMODE 900um BUFFERED GLASS OPTICAL FIBER.
- FULLY COMPLIES WITH THE FIBER OPTIC CONNECTOR PERFORMANCE REQUIREMENTS AS SPECIFIED BY TIA/EIA-568-B.3.
- MATERIAL:  
 BODY/HARDWARE: PLASTIC  
 BOOT: THERMOPLASTIC RUBBER  
 FERRULE: ZIRCONIA CERAMIC
- ALL MATERIALS AND COMPONENTS USED MEET THE MATERIAL RESTRICTIONS OF RoHS, (EUROPEAN DIRECTIVE 2002/95/EC ON THE RESTRICTION OF HAZARDOUS SUBSTANCES) AS PROPOSED BY THE RoHS TECHNICAL ADAPTATION COMMITTEE.
- DIMENSIONS IN BRACKETS ARE METRIC [mm].

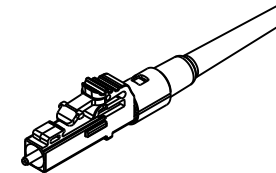
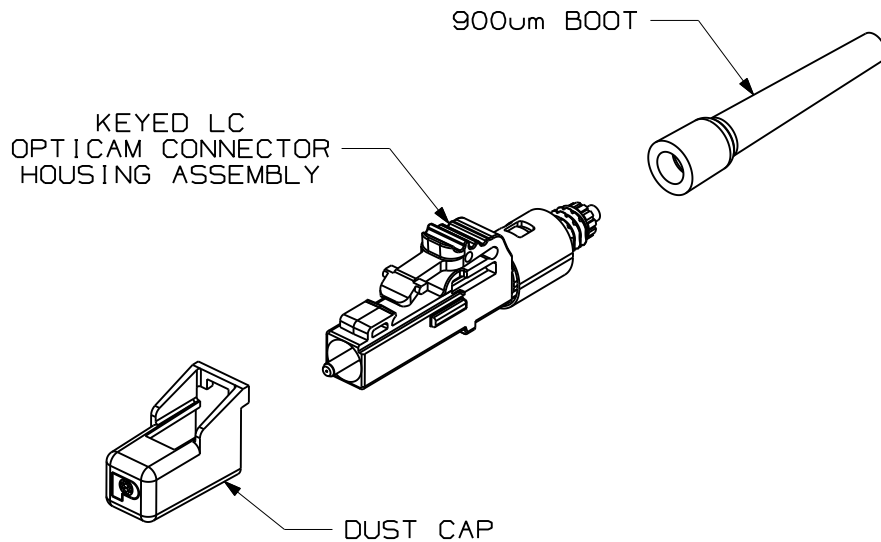

KEYED OPTICAM SIMPLEX LC CONNECTOR  
 CUSTOMER DRAWING



**PANDUIT**™  
 CORP.  
 TINLEY PARK, ILL 60477

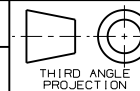

ALL DIMENSIONS ARE GIVEN IN INCHES UNLESS OTHERWISE SPECIFIED.  
 DIMENSIONAL TOLERANCES ARE:  
 (.X) ±.010 (.3)  
 (.XX) ±.03 (0.8) ANGLES

DRAWING FILENAME  
 M02759AB\_DC\_SIM\_00B.prt

SCALE  
 NONE

DRAWN BY  
 MC

REVIEW DRAWING NUMBERS

PART NO.  
 SEE SHEET 2

DATE  
 12-04-07

DRAWING NO.  
 02759-09

CHK'D  
 PJI

(SHT. 1 of 2)  
 SIZE  
 A

REV	DATE	BY	CHK	DESCRIPTION	ECN	R	CUST	SUP	OTH
1	03-19-08	MC		RELEASED TO PRODUCTION	02759-09				

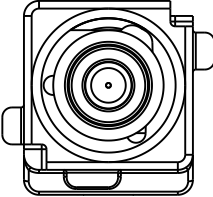
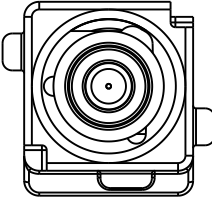
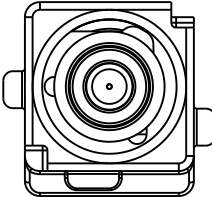
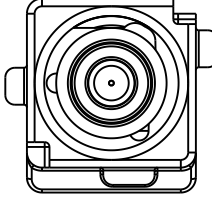
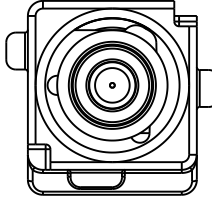
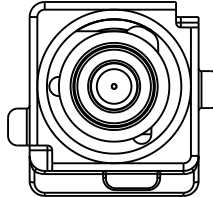
TABLE 2 - KEYED LC CONNECTOR PART NUMBER AND HOUSING KEY CONFIGURATIONS					
KEY: -A-	KEY: -B-	KEY: -C-	KEY: -D-	KEY: -E-	KEY: -F-
MULTIMODE CONNECTOR P/N: FLCSMC*ABL	MULTIMODE CONNECTOR P/N: FLCSMC*BRD	MULTIMODE CONNECTOR P/N: FLCSMC*CGR	MULTIMODE CONNECTOR P/N: FLCSMC*DYL	MULTIMODE CONNECTOR P/N: FLCSMC*EOR	MULTIMODE CONNECTOR P/N: FLCSMC*FDB
SINGLEMODE CONNECTOR P/N: FLCSSCABL	SINGLEMODE CONNECTOR P/N: FLCSSCBRD	SINGLEMODE CONNECTOR P/N: FLCSSCCGR	SINGLEMODE CONNECTOR P/N: FLCSSCDYL	SINGLEMODE CONNECTOR P/N: FLCSSCEOR	SINGLEMODE CONNECTOR P/N: FLCSSCFDB
COLOR: BLACK	COLOR: RED	COLOR: GREEN	COLOR: YELLOW	COLOR: ORANGE	COLOR: DARK BLUE
					

\* - DESIGNATES MULTIMODE FIBER TYPE (SEE TABLE 1, SHEET 1)

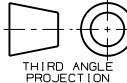
										KEYED OPTICAM SIMPLEX LC CONNECTOR CUSTOMER DRAWING		
										 <b>PANDUIT</b> ™ CORP. TINLEY PARK, ILL 60477		
										 THIRD ANGLE PROJECTION		
										ALL DIMENSIONS ARE GIVEN IN INCHES UNLESS OTHERWISE SPECIFIED. DIMENSIONAL TOLERANCES ARE: (.X) ±.03   (.XXX) ±.010   (.3) ±.015 (.XX) ±.03   (.8) ANGLES		
										DRAWING FILENAME MO2759AB_DC_SIM_00B.prt		
										SCALE NONE		
										PART NO. SEE TABLE 2		
R	03-19-08	MC		RELEASED TO PRODUCTION	02759-09						DRAWING NO. 02759-09 (SHT. 2 of 2)	SIZE A
REV	DATE	BY	CHK	DESCRIPTION	ECN	R	CUST	SUP	OTH	CHK'D	PJI	