



Chipsmall Limited consists of a professional team with an average of over 10 year of expertise in the distribution of electronic components. Based in Hongkong, we have already established firm and mutual-benefit business relationships with customers from,Europe,America and south Asia,supplying obsolete and hard-to-find components to meet their specific needs.

With the principle of "Quality Parts,Customers Priority,Honest Operation,and Considerate Service",our business mainly focus on the distribution of electronic components. Line cards we deal with include Microchip,ALPS,ROHM,Xilinx,Pulse,ON,Everlight and Freescale. Main products comprise IC,Modules,Potentiometer,IC Socket,Relay,Connector.Our parts cover such applications as commercial,industrial, and automotives areas.

We are looking forward to setting up business relationship with you and hope to provide you with the best service and solution. Let us make a better world for our industry!



Contact us

Tel: +86-755-8981 8866 Fax: +86-755-8427 6832

Email & Skype: info@chipsmall.com Web: www.chipsmall.com

Address: A1208, Overseas Decoration Building, #122 Zhenhua RD., Futian, Shenzhen, China



**Ti100, Ti105, Ti110, Ti125,
TiR105, TiR110, TiR125**
Thermal Imagers

Users Manual

LIMITED WARRANTY AND LIMITATION OF LIABILITY

Each Fluke product is warranted to be free from defects in material and workmanship under normal use and service. The warranty period is two years and begins on the date of shipment. Parts, product repairs, and services are warranted for 90 days. This warranty extends only to the original buyer or end-user customer of a Fluke authorized reseller, and does not apply to fuses, disposable batteries, or to any product which, in Fluke's opinion, has been misused, altered, neglected, contaminated, or damaged by accident or abnormal conditions of operation or handling. Fluke warrants that software will operate substantially in accordance with its functional specifications for 90 days and that it has been properly recorded on non-defective media. Fluke does not warrant that software will be error free or operate without interruption.

Fluke authorized resellers shall extend this warranty on new and unused products to end-user customers only but have no authority to extend a greater or different warranty on behalf of Fluke. Warranty support is available only if product is purchased through a Fluke authorized sales outlet or Buyer has paid the applicable international price. Fluke reserves the right to invoice Buyer for importation costs of repair/replacement parts when product purchased in one country is submitted for repair in another country.

Fluke's warranty obligation is limited, at Fluke's option, to refund of the purchase price, free of charge repair, or replacement of a defective product which is returned to a Fluke authorized service center within the warranty period.

To obtain warranty service, contact your nearest Fluke authorized service center to obtain return authorization information, then send the product to that service center, with a description of the difficulty, postage and insurance prepaid (FOB Destination). Fluke assumes no risk for damage in transit. Following warranty repair, the product will be returned to Buyer, transportation prepaid (FOB Destination). If Fluke determines that failure was caused by neglect, misuse, contamination, alteration, accident, or abnormal condition of operation or handling, including overvoltage failures caused by use outside the product's specified rating, or normal wear and tear of mechanical components, Fluke will provide an estimate of repair costs and obtain authorization before commencing the work. Following repair, the product will be returned to the Buyer transportation prepaid and the Buyer will be billed for the repair and return transportation charges (FOB Shipping Point).

THIS WARRANTY IS BUYER'S SOLE AND EXCLUSIVE REMEDY AND IS IN LIEU OF ALL OTHER WARRANTIES, EXPRESS OR IMPLIED, INCLUDING BUT NOT LIMITED TO ANY IMPLIED WARRANTY OF MERCHANTABILITY OR FITNESS FOR A PARTICULAR PURPOSE. FLUKE SHALL NOT BE LIABLE FOR ANY SPECIAL, INDIRECT, INCIDENTAL, OR CONSEQUENTIAL DAMAGES OR LOSSES, INCLUDING LOSS OF DATA, ARISING FROM ANY CAUSE OR THEORY.

Since some countries or states do not allow limitation of the term of an implied warranty, or exclusion or limitation of incidental or consequential damages, the limitations and exclusions of this warranty may not apply to every buyer. If any provision of this Warranty is held invalid or unenforceable by a court or other decision-maker of competent jurisdiction, such holding will not affect the validity or enforceability of any other provision.

Fluke Corporation
P.O. Box 9090
Everett, WA 98206-9090
U.S.A.

Fluke Europe B.V.
P.O. Box 1186
5602 BD Eindhoven
The Netherlands

11/99

To register your product online, visit <http://register.fluke.com>.

Table of Contents

Title	Page
Introduction	1
How to Contact Fluke	2
Safety Information	2
Radio Frequency Data	4
Accessories	6
Before You Start	7
How to Charge the Battery	8
Two-Bay Battery Charger Base	8
On-Imager AC Power Socket	8
Optional 12 V Vehicle Charger	9
Power On and Off	9
Features and Controls	10
Focus	11
Primary and Secondary Triggers	13
How to Use the Control Buttons	13
How to Use the Menus	14
Image Capture	14
IR-PhotoNotes™	15
Voice Records	15
Listen to a Voice Record	16
Edit Data Files	16
Save Data Files	16
SD Memory Card	17
Temperature Measurement	18
SmartView® Software	18
Menus	19
Measurement Menu	19
Range	19
Fast Auto/Manual Range Toggle	20
Fast Auto Rescale	20
Level for Manual Operation Mode	20
Temperature Span for Manual Operation Mode	21

Emissivity Adjustment.....	22
Adjust by Number.....	22
Select by Table	23
Reflected Background Temperature Compensation.....	23
Transmission/Transmittance Adjustment.....	24
Spot Temperatures	25
Spot Markers.....	26
Center Box	27
Image Menu.....	28
Palette.....	28
IR-Fusion®	30
Color Alarm.....	31
Set High-Temperature Color Alarm	31
Set Low-Temperature/Dew Point Color Alarm	32
Outside/Inside Alarm.....	32
Display Graphics Presentation.....	33
Camera Menu	33
Compass.....	33
Video.....	34
Video Recording.....	35
Video Playback.....	35
Laser Pointer	36
Torch.....	37
Backlight.....	37
CNX™ Wireless System.....	38
Memory Menu.....	39
Review Data Files	39
Delete Data Files.....	39
Settings Menu.....	40
Units.....	40
File Format.....	40
Auto Off.....	41
Date.....	42
Time.....	43
Language.....	43
Imager Information	44
Maintenance.....	45
How to Clean the Case	45
Battery Care.....	45
General Specifications	46
Detailed Specifications.....	48

List of Tables

Table	Title	Page
1.	Symbols	5
2.	Accessories	6
3.	Packing Lists.....	7
4.	Features and Controls	10
5.	Overview of Controls	13
6.	Palettes.....	29
7.	Infrared and IR-Fusion Modes by Model	30

List of Figures

Figure	Title	Page
1.	Lens Cover Laser Warning	3
2.	IR-OptiFlex Focus	12
3.	SD Memory Card Insertion and Removal.....	17
4.	Level and Span Settings.....	21

Introduction

The Fluke Ti100, Ti105, Ti110, Ti125, TiR105, TiR110, and TiR125 Thermal Imagers (the Product or Imager) are handheld, infrared imaging cameras for use in many applications. These applications include equipment troubleshooting, preventive and predictive maintenance, and building diagnostics. The Ti100 is a general-purpose Imager. The Ti105, Ti110 and Ti125 are for industrial-commercial maintenance applications. The TiR105, TiR110 and TiR125 are optimized for building inspection and diagnostics applications.

All Imagers display thermal images on a high-visibility LCD screen and can save images to an SD memory card. Saved images and data can be transferred to a PC via the SD memory card or by a direct USB connection to the PC.

The Imager includes SmartView[®] software. This software is a high-performance, professional software suite that allows for analysis and reporting. Depending on the model, the Voice Annotation and IR-PhotoNotes[™] features are also available.

Infrared images display in different color palettes on each Imager. The temperature measurement range is:

- Ti100, Ti105, Ti110 -20 °C to +250 °C
- Ti125 -20 °C to +350 °C
- TiR105, TiR110, TiR125 -20 °C to +150 °C

A rugged, rechargeable lithium-ion smart battery provides power to the Imager. Direct AC power is accessible with the included AC power adapter.

The Fluke Ti110, Ti125, TiR110, and TiR125 use the IR-OptiFlex[™] focus system. IR-OptiFlex keeps the Imager in good focus at distances more than four feet. It also allows the flexibility of one-touch manual focus to fine tune the image in close-up situations. The Fluke Ti100, Ti105, and TiR105 use a focus-free system with a large depth of field that keeps the image in good focus at distances more than four feet.

How to Contact Fluke

To contact Fluke, call one of the following telephone numbers:

- USA: 1-800-760-4523
- Canada: 1-800-36-FLUKE (1-800-363-5853)
- Europe: +31 402-675-200
- Japan: +81-3-6714-3114
- Singapore: +65-6799-5566
- Anywhere in the world: +1-425-446-5500

Or, visit Fluke's website at www.fluke.com.

To register your Product, visit <http://register.fluke.com>.

To view, print, or download the latest manual supplement, visit <http://us.fluke.com/usen/support/manuals>.

Safety Information

A **Warning** identifies hazardous conditions and actions that could cause bodily harm or death. A **Caution** identifies conditions and actions that could damage the Product or cause permanent loss of data.

Warning

To prevent eye damage and personal injury, do not look into the laser. Do not point laser directly at persons or animals or indirectly off reflective surfaces.

Additional laser warning information is on the inside of the Product lens cover, see Figure 1.

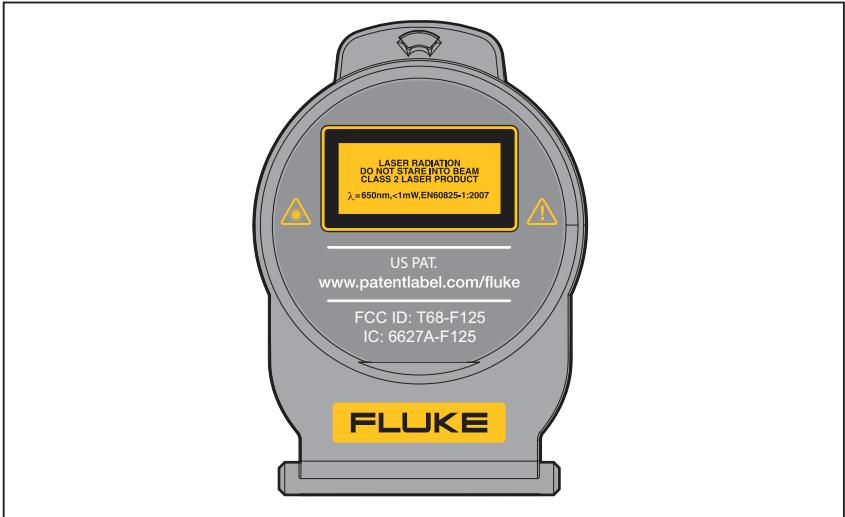

gju05.eps

Figure 1. Lens Cover Laser Warning

⚠ Warning

To prevent personal injury:

- **Read all safety information before you use the Product.**
- **Carefully read all instructions.**
- **Use the Product only as specified, or the protection supplied by the Product can be compromised.**
- **Replace the batteries when the low battery indicator shows to prevent incorrect measurements.**
- **Do not use the Product around explosive gas.**
- **Do not use the Product if it operates incorrectly.**
- **Do not use and disable the Product if it is damaged.**

Radio Frequency Data

Note

Changes or modifications to the wireless 2.4 GHz radio not expressly approved by Fluke Corporation could void the user's authority to operate the Product .

This Product complies with Part 15 of the FCC Rules. Operation is subject to the two conditions that follow:

1. This Product can not cause interference.
2. This Product must accept any interference, including interference that can cause undesired operation of the device.

Class B digital device: A digital device that is marketed for operation in a residential environment not withstanding use in commercial, business and industrial environments. Examples of such devices include, but are not limited to, personal computers, calculators, and equivalent electronic devices that are marketed for operation by the general public.



















The Product was tested and found to comply with the limits for a Class B digital device, pursuant to Part 15 of the FCC Rules. These limits are designed to provide reasonable protection against harmful interference in a residential installation. This equipment generates, uses, and can radiate radio frequency energy and, if not installed and used in accordance with the instructions, can cause harmful interference to radio communications. However, there is no guarantee that interference will not occur in a particular installation. If this equipment does cause harmful interference to radio or television reception, which can be determined by turning the equipment off and on, the user is encouraged to try to correct the interference by one or more of the measures that follow:

- Reorient or relocate the receiving antenna.
- Increase the separation between the equipment and receiver.
- Consult the dealer or an experienced radio/TV technician for help.

The term "IC:" before the radio certification number only signifies the device meets Industry's Canada technical specifications.

Table 1 is a list of symbols used on the Imager and in this manual.

Table 1. Symbols

Symbol	Description	Symbol	Description
	Battery status. Battery charging when animated.		Connected to ac power. Battery removed.
	Audio indicator		Audio recording associated with the displayed image.
	Pause recording indicator		IR-PhotoNotes™ indicator
	Video recording in process		Video file indicator
	On/Off Symbol.		Sleep mode.
	Important information. See manual.		Warning. Laser.
	Conforms to relevant Australian standards.		Conforms to relevant Canadian and US standards.
	Conforms to relevant South Korean EMC standards.		Japan Quality Association
	Conforms to requirements of European Union and European Free Trade Association.		
	This Product contains a lithium-ion battery. Do not mix with the solid waste stream. Spent batteries should be disposed of by a qualified recycler or hazardous materials handler per local regulations. Contact your authorized Fluke Service Center for recycling information.		
	This product complies with the WEEE Directive (2002/96/EC) marking requirements. The affixed label indicates that you must not discard this electrical/electronic product in domestic household waste. Product Category: With reference to the equipment types in the WEEE Directive Annex I, this product is classed as category 9 “Monitoring and Control Instrumentation” product. Do not dispose of this product as unsorted municipal waste. Go to Fluke's website for recycling information.		

Accessories

Table 2 is a list of the accessories available for the Imager.

Table 2. Accessories

Model	Description	PN
FLK-TI-SBP3	Smart Battery Pack	3440365
FLK-TI-SBC3	Charging Base/Power Supply with Adapters	3440352
TI-CAR CHARGER	12 V Vehicle Charger Adapter	3039779
FLK-TI-VISOR2	Sun Visor	3996500
FLK-TI-TRIPOD2	Tripod Mounting Accessory	3996517
BOOK-ITP	Introduction to Thermography Principles	3413459

Before You Start

Carefully unpack the items in Table 3.

Table 3. Packing Lists

Item	TI100	TI105	TI110	TI125	TIR105	TIR110	TIR125
Thermal Imager	●	●	●	●	●	●	●
AC Power Adapter	●	●	●	●	●	●	●
Two-Bay Battery Charge Base				●			●
Lithium-ion Smart Battery	1	1	1	2	1	1	2
Hard Carrying Case	●	●	●	●	●	●	●
USB Cable	●	●	●	●	●	●	●
SD Memory Card ^[1]	●	●	●	●	●	●	●
Multi-format USB Memory Card Reader				●			●
Soft Transport Bag	●	●	●	●	●	●	●
Adjustable Hand Strap (Left-hand or Right-hand use)	●	●	●	●	●	●	●
Users Manuals in print (English, Spanish, French, German, Chinese) ^[2]	●	●	●	●	●	●	●
Users Manuals on CD ^[2]	●	●	●	●	●	●	●
SmartView [®] Software	●	●	●	●	●	●	●
Warranty Registration Card	●	●	●	●	●	●	●
[1] Fluke recommends the SD memory card that is supplied with the Imager. Fluke does not warrant the use or reliability of aftermarket SD memory cards of different brands or capacities.							
[2] To request a printed manual of a language not supplied with your product, email Fluke at TPubs@fluke.com . Specify the product name and language preference in the subject line.							

How to Charge the Battery

Before you use the Imager for the first time, charge the battery for a minimum of two and one-half hours. The battery status shows on the five-segment charge indicator.

Note

New batteries are not fully charged. Two to ten charge/discharge cycles are necessary before the battery charges to its maximum capacity.

To charge the battery, use one of the options that follow:

Two-Bay Battery Charger Base



1. Connect the ac power supply to the ac wall outlet and connect the dc output to the charger base.
2. Put one or two smart batteries into bays of charger base.
3. Charge batteries until charge indicators show “full.”
4. Remove smart batteries and disconnect the power supply when batteries are fully charged.

On-Imager AC Power Socket

1. Connect the ac power adapter into an ac wall outlet and connect the dc output to the Imager’s ac power socket.  flashes in the upper left-hand corner of the display while the battery charges with the ac power adapter.
2. Charge until the charge indicator on the display does not flash.
3. Disconnect ac power adapter when the smart battery is fully charged.

Note

Make sure that the Imager is near room temperature before you connect it to the charger. See the charging temperature specification. Do not charge in hot or cold areas. When you charge in extreme temperatures, battery capacity may be decreased.

 shows in the upper left-hand corner of the display when the Imager is connected to ac power and the battery is removed. When the Imager’s power is off and the ac power adapter is connected,  flashes in the center of the display to show that the battery charge is in process.

Keep the Imager attached to the charger until the battery condition icon shows a full charge. If you remove the Imager from the charger before a full charge shows, it may have a reduced run-time.

Note

When the battery is connected to ac power, or the unit is in video mode, the Sleep Mode/Auto Off feature is disabled automatically.

Optional 12 V Vehicle Charger

1. Connect the 12 V adapter into the 12 V accessory socket of the vehicle.
2. Connect the output to the ac power socket of the Imager.
3. Charge until the indicator shows *full* on the screen.
4. Disconnect the 12 V adapter and Imager when battery is fully charged.

⚠ Caution

To prevent damage to the Imager, remove it from the DC car charger before you start or jump start the vehicle.

Power On and Off

To turn the Imager on or off, push and hold the green Power **(I)** button above the LCD for two seconds, see Table 4. When the Auto Off feature is on, the Imager goes into Sleep Mode after five minutes of inactivity and shows **(II)** on the display. Press any key to restart the Imager. After 20 minutes of inactivity, the Imager turns off. For information about how to set this feature, see page 41.

Note

All thermal imagers need sufficient warm-up time for the most accurate temperature measurements and best image quality. This time can often vary by model and by environmental conditions. Although most imagers are fully warmed up in 3-5 minutes, it is always best to wait a minimum of 10 minutes if the most accurate temperature measurement is very important to your application. When you move an Imager between environments with large differences in ambient temperature, more adjustment time can be required.

Features and Controls

Table 4 shows the Imager features and controls.

Table 4. Features and Controls

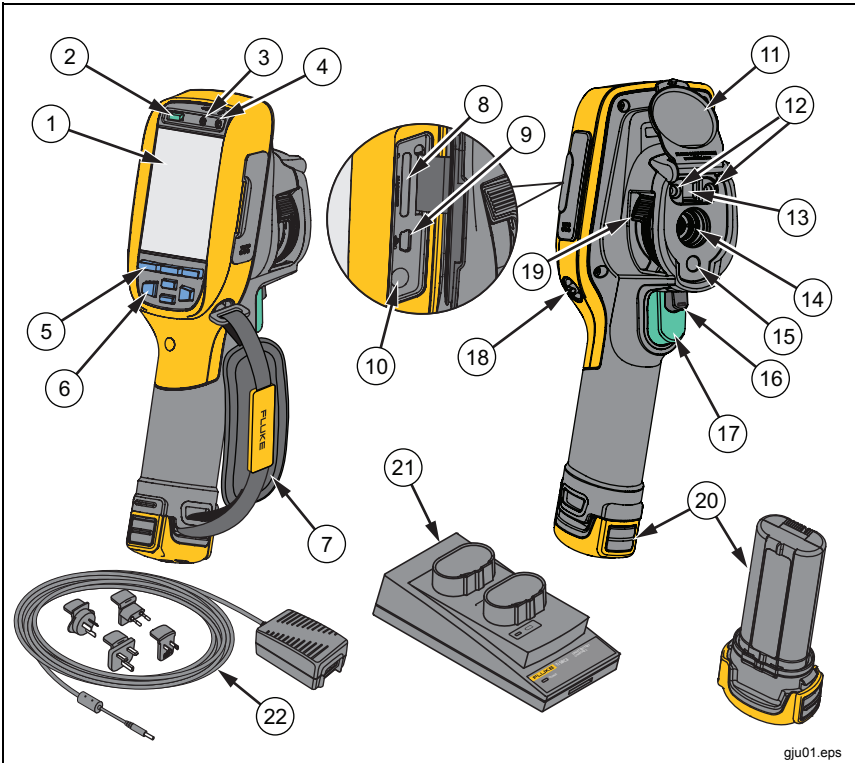

gju01.eps

Item	Description
①	LCD Display
②	⏻ Power On/Off
③	Speaker
④	Microphone
⑤	Function Buttons (F1, F2, and F3)
⑥	Arrow Buttons
⑦	Hand Strap
⑧	SD Memory Card Slot
⑨	USB Cable Connection

Table 4. Features and Controls (cont.)

Item	Description
⑩	AC Adapter/Charger Input Terminal
⑪	Retractable Lens Cover
⑫	Torch/Flashlight (not applicable for Ti100)
⑬	Visual Camera (not applicable for Ti100) and Lens
⑭	Infrared Camera Lens
⑮	Laser Pointer
⑯	Secondary Trigger
⑰	Primary Trigger
⑱	Hand Strap Anchor Post (Right and Left)
⑲	IR-OptiFlex™ Focus Control (not applicable for Ti100, Ti105, TiR105)
⑳	Lithium-ion Smart Battery
㉑	2-Bay Battery Charging Base
㉒	AC Power Adapter with Mains Adapters

Focus

Models Ti110, Ti125, TiR110, and TiR125 have IR-OptiFlex focus. The Ti100, Ti105, and TiR105 use a large depth of field focus-free system. Models with IR-OptiFlex focus can operate in a focus-free mode, but also have the flexibility for close focus situations (<122 cm/48 inches) with a one-touch, fine-tune focus capability.

The focus-free system can focus at a minimum distance of 122 cm (48 in) and beyond with no adjustment.

Correct focus is important in all imaging applications. Correct focus makes sure that the infrared energy is correctly directed onto the pixels of the detector. Without the correct focus, the thermal image can be blurry and the radiometric data will be inaccurate. Out-of-focus infrared images are frequently unusable or of little value.

To operate the IR-OptiFlex focus in the focus-free mode, align the white dot on the focus control with the white dot on the body of the Imager. You will also feel a detent at this position. See Figure 2. In this mode, in addition to correctly focused infrared images, the IR-Fusion must always be in proper alignment.

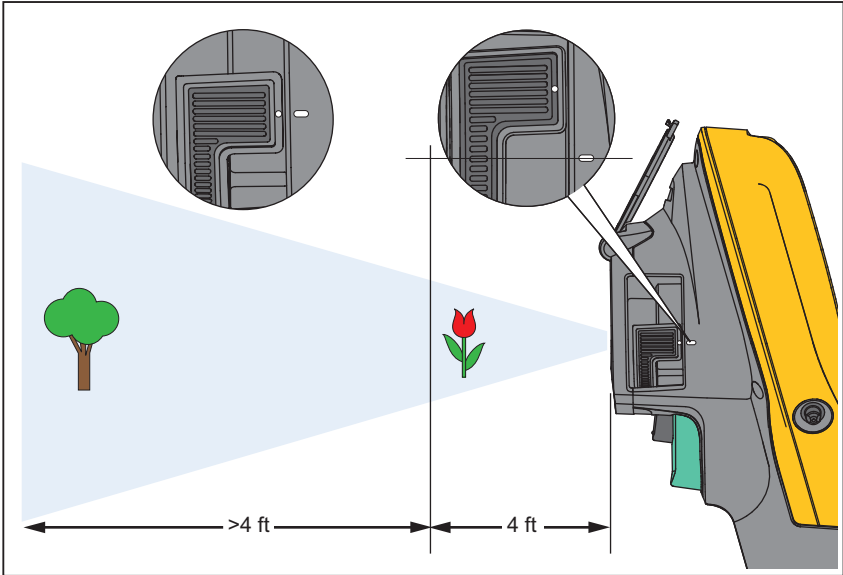

Figure 2. IR-OptiFlex Focus

gju04.eps

To operate with IR-OptiFlex focus in manual mode or to fine tune the focus, turn the one-touch focus control in a clockwise or counterclockwise direction. As you turn the focus control, you will see a live thermal image on the display as it changes. When your target comes into focus, it shows a sharper image. When the target moves out of focus, the image becomes blurry.

Primary and Secondary Triggers

The two-part trigger is located in the standard trigger position for a pistol-grip device. The larger, green trigger is the primary trigger. The smaller, black trigger is the secondary trigger.

In normal operation (video is off), the function of the primary trigger is to capture a thermal image for possible storage to memory by the user. When video is on, the primary trigger is the start/stop for video recording.

The secondary trigger operates the laser and torch. For information about how to enable the laser and torch, see pages 36 and 37.

How to Use the Control Buttons

Three function buttons (**F1**, **F2**, **F3**) and four arrow buttons (◀◁, ▷▷, ▲, and ▼) are the primary controls. These buttons move the cursor through the menu structure to set the features.

Table 5 is an overview of the buttons and their actions. In live Manual Mode, the arrow buttons are always active to adjust Level and Span.





Table 5. Overview of Controls

Button	Button Label / Action
F3 , Trigger	Cancel
F1 , Trigger	Done (exit from Menu structure)
F1 , ▷▷	Select or OK
F2 , ◀◁	Back
▲, ▼	Move cursor to highlight an option
▷▷, ◀◁	Fast forward/rewind (video mode only)

How to Use the Menus

The menus, coupled with the three function buttons (F1, F2, F3) and arrow buttons, are the access for thermal image display, camera features, memory review, and settings for date, time, language, units, file format, and Imager information.

To open the primary menu, push F2 or . The primary menu shows five secondary menus for Measurement, Image, Camera, Memory, and Settings. The text above each function button (F1, F2, F3) applies to that button throughout all menu screens.

Push F2 to open the primary menu and push / to cycle through the secondary menus. Each secondary menu lists an options menu. Push / to cycle through the options.

The primary, secondary, and option menus close 10 seconds after the last push of a function button. The option selection menu stays open until you make the selection, go up a menu level, or cancel the action.

Image Capture

Point the imager at the object or area of interest. Make sure that the object is in focus. Pull and release the primary trigger. This will capture and freeze the image. To cancel the captured image, pull the primary trigger again or F3 to return to the Live view.

Depending on the selected file format settings, the Imager shows the captured image and a menu bar. The menu bar lets you save the image, edit some image settings, and add voice annotation or IR-PhotoNotes. To change the file format, see *File Format* on page 40.

IR-PhotoNotes™

IR-PhotoNotes™ are photograph annotations that allow the user to capture and add multiple visible images of various objects, text, or other information that is related to the analysis and reporting of an infrared image. Examples of an annotation include motor name plates, printed information or warning signs, larger views of the environment or room, and related equipment. Up to three images can be captured with the visible image that is stored with the infrared image as part of IR-Fusion technology. These visible images are only available in the .is2 file format and are stored in the file so you do not need to collate multiple files at a later time.

To add IR-PhotoNotes:

1. With an image in the buffer, push **F2** to open the **EDIT IMAGE** menu.
2. Push **▲**/**▼** to highlight **IR-PhotoNotes**.
3. Push **▶** to enter the Picture mode.
4. Focus Imager on the object and pull the primary trigger.
5. Push **F2** to continue.
6. Push **F1** save the picture with the image.

Voice Records

To add a voice (audio) record:

1. With an image in the buffer, push **F2** to open the **EDIT IMAGE** menu.
2. Push **▲**/**▼** to highlight **Add Audio**.
3. Push **F1** to record up to 60 seconds of audio. The display updates to show the recorded time.
4. Push **F1** to pause the recorder.
5. Push **F2** when done.
6. Push **F1** to review the audio file or **F2** to save the audio with the image.

Listen to a Voice Record

The voice (audio) record replays through the speaker.





To playback an .is2 file on the SD memory card:

1. Do the steps in the *Review Data Files* section on page 39 to see the image on the display.
2. Push **F1**.
3. Push **F1** or  to set **Audio**.
4. Push **F1** to listen to the audio.
5. Push **F1** again to pause the audio.

Edit Data Files

Before saving a file, you can edit or modify the image.

To edit:

1. With an image in the buffer, push **F2** to open the **EDIT IMAGE** menu.
2. Push / to highlight **Edit Image**.
3. Push  to open the **EDIT IMAGE** menu.
4. Push / to highlight an option.
5. Push **F1** to save the changes with the file.

Save Data Files

To save an image as a data file:

1. Focus on the object of interest or inspection area.
2. Pull the trigger to capture the image. The image is now in the buffer and you can save or edit.
3. Push **F1** to save the image as a file and go back to the live view.

SD Memory Card

To eject an SD memory card, push in on the exposed edge of the card and then release. The card should pop partially out after you release it. Carefully pull the card out of the slot.

To use the SD memory card, make sure that the write-protect lock is open. See Figure 3. Carefully push the card into the slot with the card label facing away from the LCD. Push the card in until it catches.

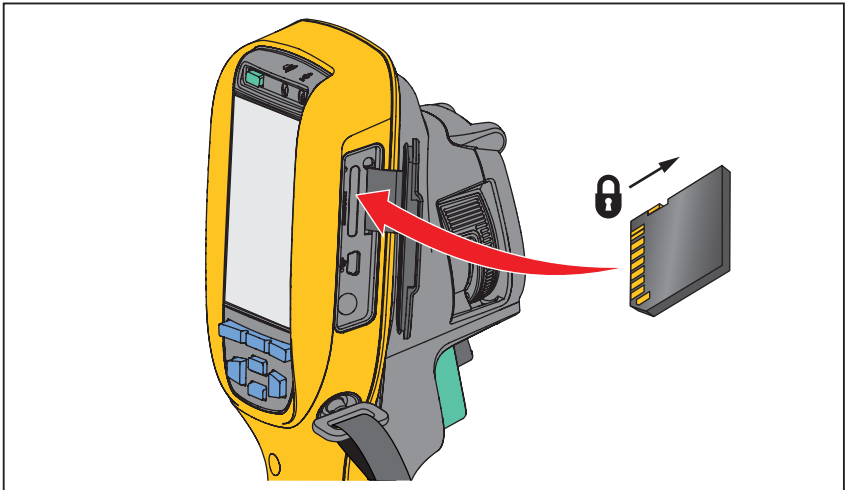

gju03.eps

Figure 3. SD Memory Card Insertion and Removal

For information about how to save data, see page 16. For information about how to view or erase a stored image, see page 39.

Temperature Measurement

All objects radiate infrared energy. The quantity of energy radiated is based on the actual surface temperature and the surface emissivity of the object. The Imager senses the infrared energy from the surface of the object and uses this data to calculate an estimated temperature value. Many common objects and materials such as painted metal, wood, water, skin, and cloth are very good at radiating energy and it is easy to get relatively accurate measurements. For surfaces that are good at radiating energy (high emissivity), the emissivity factor is $\geq 90\%$ (or 0.90). This simplification does not work on shiny surfaces or unpainted metals as they have an emissivity of < 0.60 . These materials are not good at radiating energy and are classified as low emissivity. To more accurately measure materials with a low emissivity, an emissivity correction is necessary. Adjustment to the emissivity setting will usually allow the Imager to calculate a more accurate estimate of the actual temperature.

Warning

To prevent personal injury, see emissivity information for actual temperatures. Reflective objects result in lower than actual temperature measurements. These objects pose a burn hazard.

Note

Surfaces with an emissivity < 0.60 make reliable and consistent determination of actual temperatures problematic. The lower the emissivity, the more potential error is associated with the Imager's temperature measurement calculations, even when emissivity and reflected background adjustments are attempted and performed properly.

More information is available on emissivity. We recommend the study of this topic to get the most accurate temperature measurements.

SmartView[®] Software

SmartView[®] software is supplied with the Imager. This software is intended for Fluke Imagers and contains features to analyze images, organize data and information, and make professional reports. SmartView[®] allows audio annotations and IR-PhotoNotes to be reviewed on a PC. SmartView[®] is used to export IR and visible images as .jpeg, .jpg, .jpe, .jfif, .bmp, .gif, .dip, .png, .tif, or .tiff formatted files.

Menus









The menus, together with the three function buttons (**F1**, **F2**, **F3**) and arrow buttons, are access for thermal image display, camera features, memory setup, and settings for date, time, language, units, file format, and Imager information.

Measurement Menu

The Measurement Menu has settings for the calculation and display of radiometric temperature measurement data related to the thermal images. These settings include the Range (Auto and Manual Level and Span adjustment), Emissivity, Background, Transmission, Spot Temperatures, Markers, and Center Box.

Range

Range (level and span) is set to automatically adjust or is set for manual adjustment. To choose between automatic or manual level and span, do the following:

1. Push **F2**.
2. Push / to highlight **Measurement**.
3. Push **F1** or  to view the menu.
4. Push / to highlight **Range**.
5. Push **F1** or  to view the menu.
6. Push / to toggle between the Auto and Manual ranging.
7. Push **F1** to set.
8. Push:
 - **F1** to set the change and go back to the live view.
 - **F2** or  to set the change and go back to the previous menu.
 - **F3** to cancel the change and go back to the live view.