



Chipsmall Limited consists of a professional team with an average of over 10 year of expertise in the distribution of electronic components. Based in Hongkong, we have already established firm and mutual-benefit business relationships with customers from,Europe,America and south Asia,supplying obsolete and hard-to-find components to meet their specific needs.

With the principle of “Quality Parts,Customers Priority,Honest Operation,and Considerate Service”,our business mainly focus on the distribution of electronic components. Line cards we deal with include Microchip,ALPS,ROHM,Xilinx,Pulse,ON,Everlight and Freescale. Main products comprise IC,Modules,Potentiometer,IC Socket,Relay,Connector.Our parts cover such applications as commercial,industrial, and automotives areas.

We are looking forward to setting up business relationship with you and hope to provide you with the best service and solution. Let us make a better world for our industry!



## Contact us

Tel: +86-755-8981 8866 Fax: +86-755-8427 6832

Email & Skype: info@chipsmall.com Web: www.chipsmall.com

Address: A1208, Overseas Decoration Building, #122 Zhenhua RD., Futian, Shenzhen, China





# **HAKKO** MODEL **PARALLEL REMOVER** **FM-2022**

PARALLEL REMOVER  
Iron holder with a sleep mode

## **Instruction Manual**

●  
Thank you for purchasing the FM-2022 parallel remover.  
Please read this manual before operating the FM-2022. Keep this  
manual readily accessible for reference.

●  
 **CAUTION**

- The FM-2022 cannot function by itself. It must be connected to the HAKKO FM-203 or FM-206 station.
- Specific information can be found in the instruction manual for your HAKKO FM-203/FM-206 station.

### **TABLE OF CONTENTS**

1. PACKING LIST .....	1
2. SPECIFICATIONS .....	1
3. WARNINGS, CAUTIONS AND NOTES .....	2
4. PART NAMES .....	3
5. SETTING UP THE FM-2022 .....	3
6. OPERATION .....	4
7. MAINTENANCE .....	7
8. TROUBLESHOOTING GUIDE .....	8
9. PARTS LIST .....	10
10. WIRING DIAGRAM .....	11

# 1. PACKING LIST

Parallel remover.....	1	Iron holder .....	1
Heat resistant pad .....	1	Instruction manual .....	1
Connecting cable .....	1		

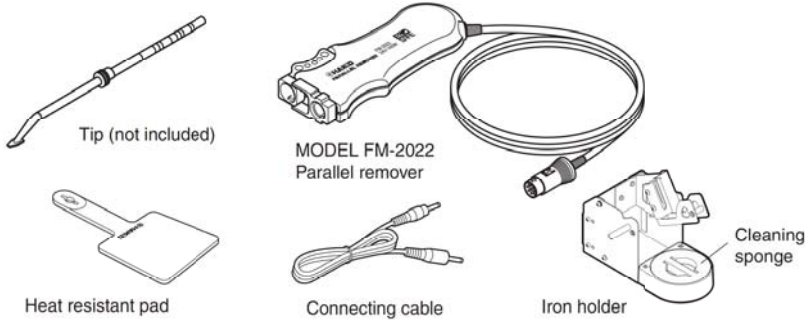

## ● Applicable Models

In order to function, the FM-2022 must be connected to the HAKKO FM-203 or FM-206 station.

# 2. SPECIFICATIONS

## ● MODEL FM-2022 Parallel remover

Power Consumption	140W (24V)
Temperature Range	200 – 400°C (400 – 750°F)
Tip to Ground Resistance	< 2Ω
Tip to Ground Potential	< 2mV (typical 0.6mV)
Cord Assembly	1.2m (4 ft.)
Total Length (w/o cord)	110mm (w/o tip)
Weight (w/o cord)	53g (Parallel remover only) 11g (SOP 25L Tip only)

\* This product is protected against electrostatic discharge.

\* Specifications and design are subject to change without notice.

**⚠ CAUTION:**  
 This product includes such features as electrically conductive plastic parts and grounding of the handpiece and station as measures to protect the device to be soldered from the effects of static electricity. Be sure to observe the following instructions:

1. The handle and other plastic parts are not insulators, they are conductors. When replacing parts or repairing, take sufficient care not to expose live electrical parts or damage insulation materials.
2. Be sure to ground the unit during use.

## 3. WARNINGS, CAUTIONS AND NOTES

Warnings, cautions and notes are placed at critical points in this manual to direct the operator's attention to significant items. They are defined as follows:

 **WARNING:** Failure to comply with a WARNING may result in injury or death.

 **CAUTION:** Failure to comply with a CAUTION may result in injury to the operator, or damage to the items involved. (One example is given below.)

**NOTE:** A NOTE indicates a procedure or point that is important to the process being described.

### CAUTION

When the power is on, the tip temperature is between 200°C/400°F and 400°C/750°F. Since mishandling may lead to burns or fire, be sure to comply with the following precautions:

- Do not touch the metal parts near the tip.
- Do not use the product near flammable items.
- Advise other people in the work area that the unit can reach a very high temperature and should be considered potentially dangerous.
- Turn off the power while taking breaks and when finished using the unit.
- Before replacing parts or storing the unit, turn off the power and allow the unit to cool to room temperature.

### CAUTION

To prevent damage to the unit and ensure a safe working environment, be sure to comply with the following precautions:

- Do not use the unit for applications other than those specifically described in the instruction manual.
- Do not set the tip temperature higher than 400°C/750°F.
- Do not rap the FM-2022 against the work bench to shake off residual solder, or otherwise subject the iron to severe shocks.
- Do not modify the unit.
- Use only genuine HAKKO replacement parts.
- Do not wet the unit or use the unit when your hands are wet.
- The operating process will produce smoke. Make sure the area is well ventilated.
- Pull on the plug to disconnect the FM-2022 from the station outlet. Do not pull the cord.

## 4. PART NAMES

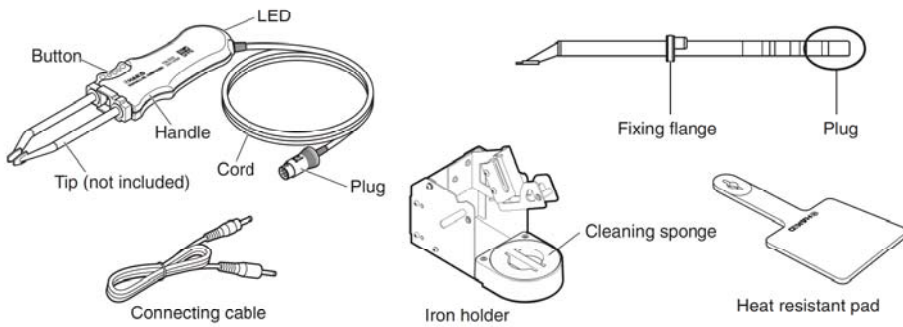

## 5. SETTING UP THE FM-2022

### 1. Connector cord

Pass the connector cord through the hole in the heat resistant pad.

### 2. Iron holder

When the iron holder is connected with the HAKKO FM-203 or FM-206 station by using a connecting cable, the sleep function can be used.

Refer to the HAKKO FM-203 instruction manual for how to set the sleep time. Detailed information for HAKKO FM-206 on how to set the sleep time can be found in manuals available at the HAKKO Document Portal. Please download and refer to it.

### 3. Connections

1. Connect the cord assembly of the FM-2022 to the receptacle of HAKKO FM-203 or FM-206.

**NOTE:**

When MODEL FM-2022 is connected to FM-206, be sure not to connect an incompatible device because each receptacle connector differs.

2. Place the MODEL FM-2022 in the iron holder.
3. Plug the power cord into the power supply. Be sure to ground the unit.

**NOTE:**

This product is protected against electrostatic discharge and must be grounded for full efficiency.

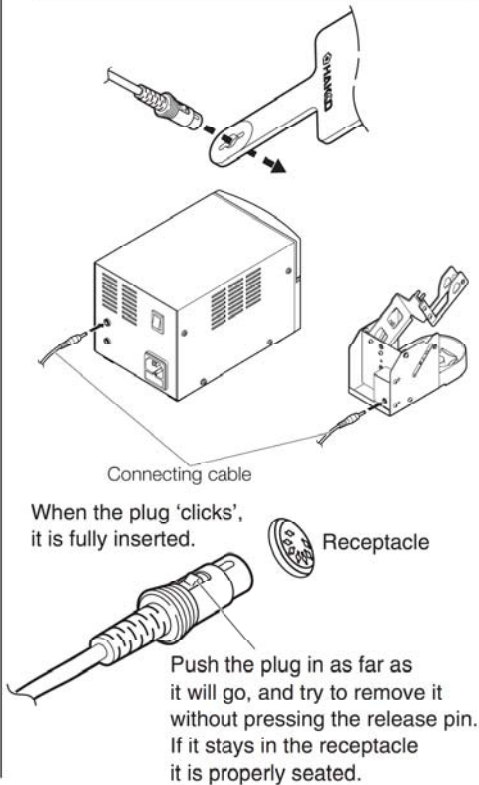

## 6. OPERATION

### ● Controls and displays

Refer to the HAKKO FM-203 or FM-206 instruction manual.

**NOTE:**

The HAKKO FM-203 has 2 channels; D and S channel. The MODEL FM-2022 can be connected to only the D channel.

The HAKKO FM-206 has 3 channels: 1, 2 and 3 channel. MODEL FM-2022 can be connected to only the channel 2.

Refer to the HAKKO FM-203/FM-206 instruction manual for details of operating.

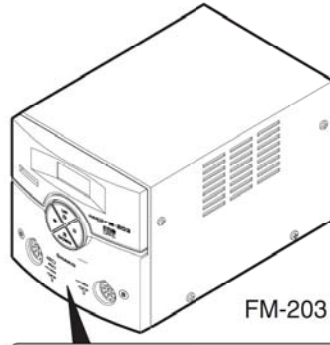

FM-203 Station

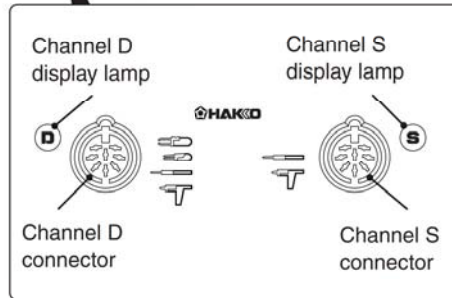

### ● Displays

1. Insert the tips:

Hold the head part of the tip with the heat resistant pad and insert the tip into the handpiece. Push until the tip stops. Repeat for second tip.

**NOTE:**

The tips are a set of 2 pieces with the same tip style. They must be used together.

2. Turn the power switch ON.

3. When the set temperature is reached, the buzzer sounds

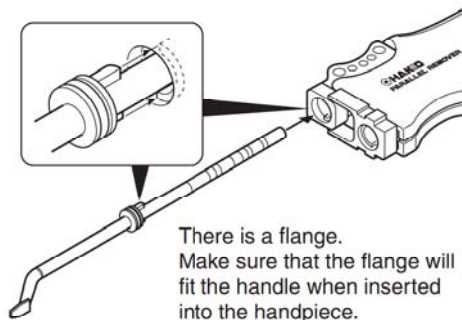

**NOTE:**

Once the two tips are inserted into the handpiece, heat control begins.

Both tips of the set must be inserted or the handpiece will not heat.

## ● Operating instructions

### 1. Set the Temperature

### 2. Apply solder or flux

If there is insufficient solder on the PWB, or the soldered area is too small, apply solder or flux to the PWB. Solder may also be applied to the tip.

### 3. Melt the solder

Place the tip on the soldered part and melt the solder. Confirm that the solder is fully melted. See sketch "A".

### 4. Remove the component

After confirming that the solder is fully melted, lightly squeeze the handpiece to grasp the component and lift to remove the component. See sketch "B".

**⚠ CAUTION:**

The tip is very hot during operation.  
Do not touch the tip or the metal parts near the tip.

**⚠ CAUTION:**

Very high tip temperatures may damage the printed circuit board, possibly causing the printed pattern to become detached. HAKKO recommends setting the tip temperature below 300°C (572°F) for all normal work. Using the lowest possible effective temperature not only helps protect parts that are sensitive to heat, it also helps protect the tip from deterioration caused by heat.

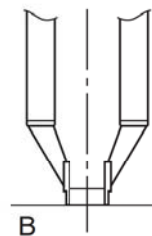
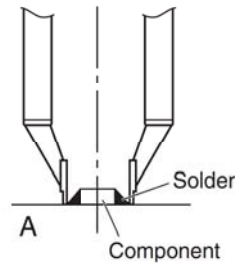

---

## ● Control card and changing the temperature setting

Please refer to the HAKKO FM-203 or FM-206 Instruction Manual.

## ● Replacing the tip

Removing and inserting the tip:

Removing the tip:

Hold the handle and pull the tip out of the handpiece with the heat resistant pad.

Inserting the tip:

Hold head part and insert the tip into the handpiece. Push until the tip stops.

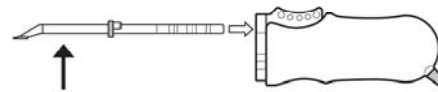

Hold this part to insert into the tweezer.

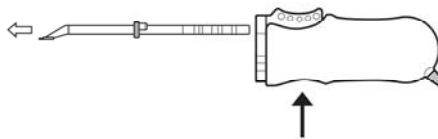

Hold the tweezer at the front to remove tip.

**⚠ CAUTION:**

The tip can be very HOT. Use the heat resistant pad for handling hot tips, but do not hold the hot portion of the tip, even with the pad, for longer than necessary.



# 7. MAINTENANCE

## ● Tip maintenance

Please refer to the HAKKO FM-203 or FM-206 Instruction manual.

## ● Checking Procedure

### ⚠ WARNING:

Unless otherwise directed, carry out these procedures with the power switch OFF and the power UNPLUGGED.

- Verify the electrical integrity of the heater and sensor

1. Check for a broken heater or sensor

Measure the resistance across this position

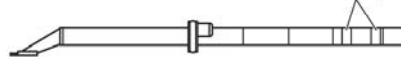

Measure the resistance across the tip as shown. Measure the resistance while at room temperature (15 to 25°C; 59 to 77°F). It should be  $8\Omega \pm 10\%$ . If the resistance exceeds these limits, replace the tip.

- Check the grounding line

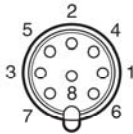

1. Unplug the connection cord from the station.
2. Measure the resistance value between pin 2 and the tip (both tips).
3. If the resistance value is higher than  $2\Omega$  (at room temperature), remove the black oxide or replace the tip with a new one. If the resistance value still does not decrease, check the connection cord for breakage.

- Checking the connection cord for breakage (Refer to P.11 WIRING DIAGRAM of B side.)

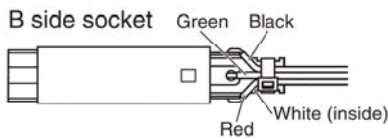

1. Remove the soldering tip and the handle.
2. Measure the resistance values between the connector and the lead wires at the socket as follows:  
Pin 1 - Red      Pin 2 - Green  
Pin 3 - Black     Pin 5 - White  
If any value exceeds  $0\Omega$  or is  $\infty$ , replace the FM-2022.

- Checking the connection cord for breakage (Refer to P.11 WIRING DIAGRAM of A side.)

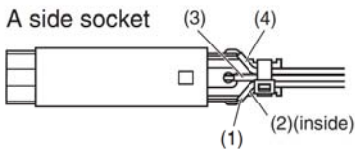

1. Remove the soldering tip and the handle.
2. Measure the resistance values between the connector and the lead wires at the socket as follows:

Pin 7 - (1)      Pin 2 - (3)  
Pin 4 - (4)      Pin 8 - (2)

If any value exceeds  $0\Omega$  or is  $\infty$ , replace the FM-2022.

## 8. TROUBLESHOOTING GUIDE

**⚠ WARNING:**

Disconnect the power plug before servicing.  
Failure to do so may result in electric shock.

- The tip does not heat up.

- The sensor error **S-E** is displayed.

**CHECK** : Is the tip inserted properly?

**ACTION** : Insert the tip completely.

**CHECK** : Is the connection cord and/or the heater/sensor broken?

**ACTION** : See the appropriate section of this manual regarding how to check the connection cord and/or the heater/sensor for breakage.

- Solder does not wet the tip.

**CHECK** : Is the tip temperature too high?

**ACTION** : Set the appropriate temperature.

**CHECK** : Is the tip contaminated with oxide?

**ACTION** : Remove the oxide by cleaning the tip on a damp sponge of HAKKO 599B tip cleaner.

- The tip temperature is too high.

**CHECK** : Is the connection cord broken?

**ACTION** : See "Checking the connection cord for breakage".

● The tip temperature is too low.

**CHECK** : Is the tip contaminated with oxide?

**ACTION** : Remove the oxide by cleaning the tip on a damp sponge of Hakko 599B tip cleaner.

● The soldering iron error  $\boxed{L-E}$  is displayed.

**CHECK** : Is the connection cord broken?

**ACTION** : See "Checking the connection cord for breakage".

**CHECK** : Is the FM-2022 plug disconnected?

**ACTION** : Connect the FM-2022.

● The low-temperature alarm tolerance error  $\boxed{H-E}$  occurs frequently.

**CHECK** : Is the tip too small for the items to be removed?

**ACTION** : Use a tip with a large thermal capacity.

**CHECK** : Is the setting value for the low-temperature alarm tolerance too low?

**ACTION** : Increase the setting value.

● Heater terminal short circuit error  $\boxed{HSE}$  is displayed.

**CHECK** : Is the tip for FM-2022?

**ACTION** : Turn the power switch OFF and insert the correct FM-2022 tip. Turn the power switch ON.

● The tips cannot be closed.

**CHECK** : Is there a foreign object between the tips?

- The tips will not return to the original position.

**ACTION** : Remove it.

## 9. PARTS LIST

### NOTE:

Replacement parts do not include mounting screws if they are not listed on the description. Screws must be ordered separately.

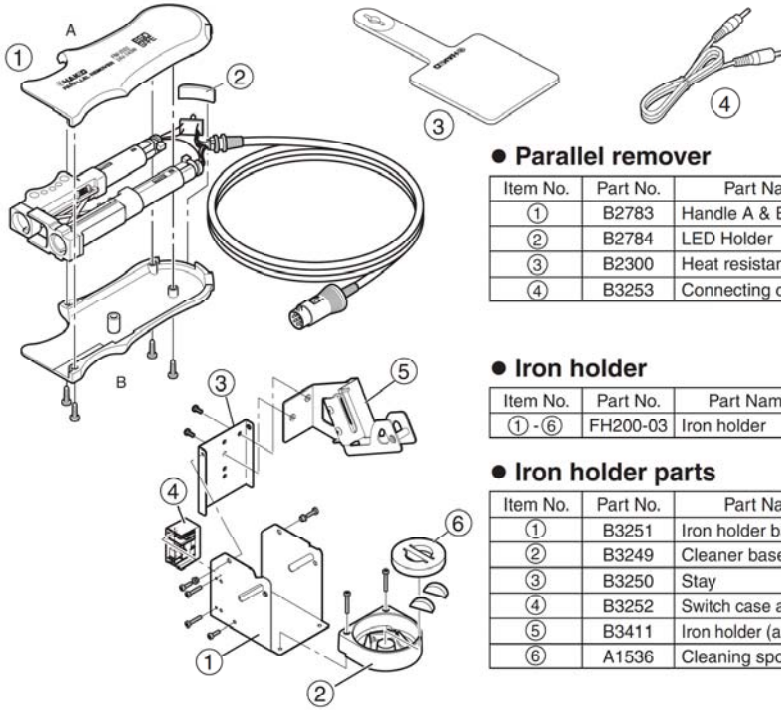

### ● Parallel remover

Item No.	Part No.	Part Name	Specifications
①	B2783	Handle A & B	With screws
②	B2784	LED Holder	
③	B2300	Heat resistant pad	
④	B3253	Connecting cable	

### ● Iron holder

Item No.	Part No.	Part Name	Specifications
① - ⑥	FH200-03	Iron holder	With cleaning sponge

### ● Iron holder parts

Item No.	Part No.	Part Name	Specifications
①	B3251	Iron holder base	With rubber feet
②	B3249	Cleaner base	
③	B3250	Stay	
④	B3252	Switch case assembly	
⑤	B3411	Iron holder (assembly)	With screws
⑥	A1536	Cleaning sponge	

### ● Tips

	Part No.	Part Name	Size A [a]	Shape
CHIP	T16-1001	Tip/CHIP 0.5I	R0.2 mm (0.008 in.)	
	T16-1002	Tip/CHIP 0.5C	1.5 [0.5] mm (0.06 [0.02] in.)	
	T16-1003	Tip/CHIP 1L	1 mm (0.04 in.)	
	T16-1004	Tip/CHIP 2L	2 mm (0.08 in.)	
	T16-1013	Tip/CHIP 3L	3 mm (0.12 in.)	
SOP	T16-1005	Tip/SOP 6L	6 mm (0.24 in.)	
	T16-1006	Tip/SOP 8L	8 mm (0.31 in.)	
	T16-1007	Tip/SOP 10L	10 mm (0.39 in.)	
	T16-1008	Tip/SOP 13L	13 mm (0.51 in.)	
	T16-1009	Tip/SOP 16L	16 mm (0.63 in.)	
	T16-1010	Tip/SOP 20L	20 mm (0.79 in.)	
	T16-1011	Tip/SOP 25L	25 mm (0.98 in.)	
	T16-1012	Tip/SOP 18L	18 mm (0.71 in.)	

\* The temperature accuracy of the above iron tips is  $\pm 15^{\circ}\text{C}$  ( $\pm 27^{\circ}\text{F}$ ).

# 10. WIRING DIAGRAM

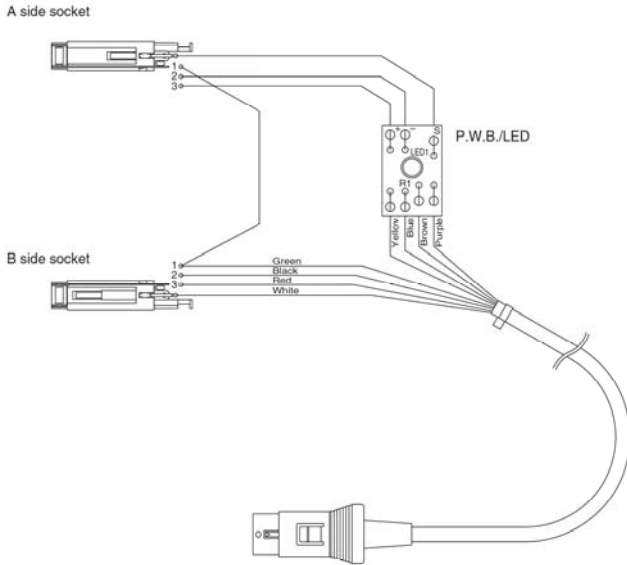

※ 各言語（日本語、英語、中国語、フランス語、ドイツ語、韓国語）の取扱説明書は以下のURL、HAKKO Document Portalからダウンロードしてご覧いただけます。  
（商品によっては設定の無い言語がありますが、ご了承ください）

\* 各國語言(日語,英語,中文,法語,德語,韓語)的使用說明書可以通過以下網站的HAKKO Document Portal 下載參閱。  
（有一部分的产品沒有設定外語對應,請見諒）

- Instruction manual in the language of Japanese, English, Chinese, French, German and Korean can be downloaded from the HAKKO Document Portal.  
(Please note that some languages may not be available depending on the product.)

<https://doc.hakko.com>



**HAKKO CORPORATION**

**HEAD OFFICE**

4-5, SHIOKUSA 2-CHOME, NANIWA-KU, OSAKA, 556-0024 JAPAN

TEL:+81-6-6561-3225 FAX:+81-6-6561-8466

<http://www.hakko.com>

**AMERICAN HAKKO PRODUCTS, INC.**

28920 N. AVENUE WILLIAMS VALENCIA CA 91355, U.S.A.

TEL: (661) 294-0090 FAX: (661) 294-0096

Toll Free (800)88-HAKKO [www.hakkousa.com](http://www.hakkousa.com)

4 2 5 5 6

Copyright © 2011 HAKKO Corporation. All Rights Reserved.