



Chipsmall Limited consists of a professional team with an average of over 10 year of expertise in the distribution of electronic components. Based in Hongkong, we have already established firm and mutual-benefit business relationships with customers from,Europe,America and south Asia,supplying obsolete and hard-to-find components to meet their specific needs.

With the principle of “Quality Parts,Customers Priority,Honest Operation,and Considerate Service”,our business mainly focus on the distribution of electronic components. Line cards we deal with include Microchip,ALPS,ROHM,Xilinx,Pulse,ON,Everlight and Freescale. Main products comprise IC,Modules,Potentiometer,IC Socket,Relay,Connector.Our parts cover such applications as commercial,industrial, and automotives areas.

We are looking forward to setting up business relationship with you and hope to provide you with the best service and solution. Let us make a better world for our industry!



Contact us

Tel: +86-755-8981 8866 Fax: +86-755-8427 6832

Email & Skype: info@chipsmall.com Web: www.chipsmall.com

Address: A1208, Overseas Decoration Building, #122 Zhenhua RD., Futian, Shenzhen, China





HAKKO MODEL MINI PARALLEL REMOVER **FM-2023**

MINI PARALLEL REMOVER
Iron holder with a sleep mode

Instruction Manual

•
Thank you for purchasing the FM-2023 mini parallel remover.
Please read this manual before operating the FM-2023. Keep this
manual readily accessible for reference.

•
 **CAUTION**

- The FM-2023 cannot function by itself. It must be connected to the HAKKO FM-202 or FM-206 station.
- Specific information can be found in the instruction manual for your HAKKO FM-202/FM-206 station.

TABLE OF CONTENTS

1. PACKING LIST	1
2. SPECIFICATIONS	1
3. WARNINGS, CAUTIONS AND NOTES.....	2
4. PART NAMES.....	3
5. SETTING UP THE FM-2023.....	3
6. OPERATION.....	4
7. MAINTENANCE	7
8. TROUBLESHOOTING GUIDE	8
9. PARTS LIST.....	10
10. WIRING DIAGRAM	11

1. PACKING LIST

Mini parallel remover handpiece	1	Tip ID number key	1
Tips (T9-I) 2pcs/set	1	Holder clip (w/screw)	1
Heat resistant pad	1	Component bed	1
Cleaning sponge.....	1		

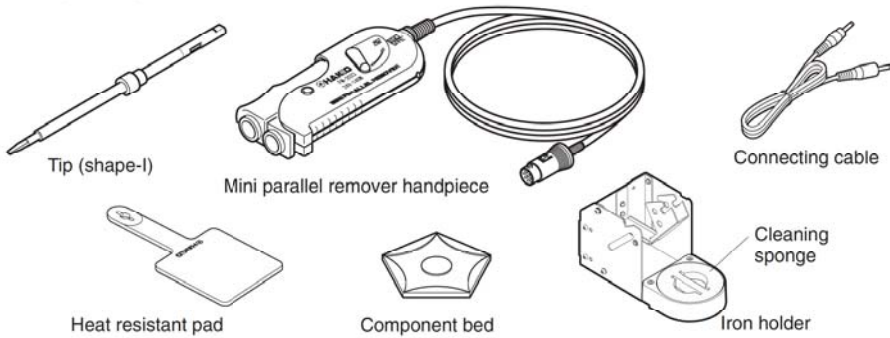

- **Applicable Models**
In order to function, the FM-2023 must be connected to the HAKKO FM-202 or FM-206 station.

2. SPECIFICATIONS

● MODEL FM-2023 Mini Parallel Remover

Power consumption	140W (24 V)
Temperature range	200 – 400°C
Tip to ground resistance	< 2Ω
Tip to ground potential	< 2mV
Cord assembly	1.2m
Length (w/o cord)	75mm (w/o tip)
Weight (w/o cord)	32g (Handpiece only), 5g (I tip only)
Standard tip	T9-I (Shape-I)

- * This product is protected against electrostatic discharge.
- * Specifications and design are subject to change without notice.

⚠ CAUTION:
This product includes such features as electrically conductive plastic parts and grounding of the handpiece and station as measures to protect the device to be soldered from the effects of static electricity. Be sure to observe the following instructions:

1. The handle and other plastic parts are not insulators, they are conductors. When replacing parts or repairing, take sufficient care not to expose live electrical parts or damage insulation materials.
2. Be sure to ground the unit during use.

3. WARNINGS, CAUTIONS AND NOTES

Warnings, cautions and notes are placed at critical points in this manual to direct the operator's attention to significant items. They are defined as follows:

 **WARNING:** Failure to comply with a WARNING may result in injury or death.

 **CAUTION:** Failure to comply with a CAUTION may result in injury to the operator, or damage to the items involved. (One example is given below.)

NOTE: A NOTE indicates a procedure or point that is important to the process being described.

CAUTION

When the power is on, the tip temperature is between 200°C/400°F and 400°C/750°F. Since mishandling may lead to burns or fire, be sure to comply with the following precautions:

- Do not touch the metallic parts near the tip.
- Do not use the product near flammable items.
- Advise other people in the work area that the unit can reach a very high temperature and should be considered potentially dangerous.
- Turn off the power while taking breaks and when finished using the unit.
- Before replacing parts or storing the unit, turn off the power and allow the unit to cool to room temperature.

CAUTION

To prevent damage to the unit and ensure a safe working environment, be sure to comply with the following precautions:

- Do not use the unit for applications other than those specifically described in the instruction manual.
- Do not set the tip temperature higher than 400°C/750°F.
- Do not rap the FM-2023 against the work bench to shake off residual solder, or otherwise subject the iron to severe shocks.
- Do not modify the unit.
- Use only genuine HAKKO replacement parts.
- Do not wet the unit or use the unit when your hands are wet.
- The operating process will produce smoke. Make sure the area is well ventilated.
- Pull on the plug to disconnect the FM-2023 from the station outlet. Do not pull the cord.

4. PART NAMES

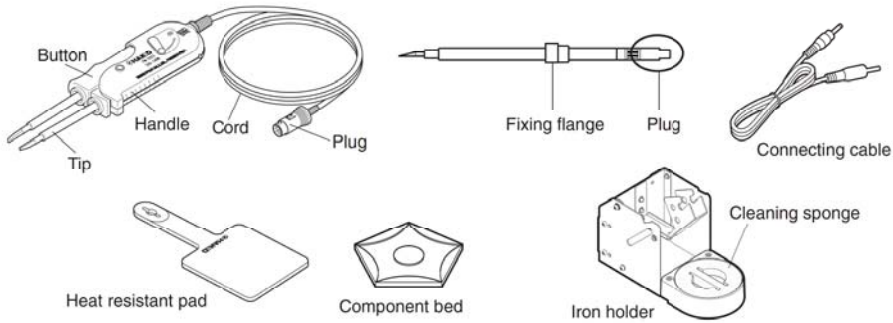

5. SETTING UP THE FM-2023

1. Connector cord

Pass the connector cord through the hole in the heat resistant pad.

2. Iron holder

When the iron holder is connected with the HAKKO FM-203 or FM-206 station by using a connecting cable, the sleep function can be used.

Refer to the HAKKO FM-203 instruction manual for how to set the sleep time.

Detailed information for HAKKO FM-206 on how to set the sleep time can be found in manuals available at the HAKKO Document Portal. Please download and refer to it.

3. Connections

1. Connect the cord assembly of the FM-2023 to the receptacle of HAKKO FM-203 or FM-206.

NOTE:

When MODEL FM-2023 is connected to FM-206, be sure not to connect an incompatible device because each receptacle connector differs.

2. Place the FM-2023 in the iron holder.
3. Plug the power cord into the power supply. Be sure to ground the unit.

NOTE:

This product is protected against electrostatic discharge and must be grounded for full efficiency.

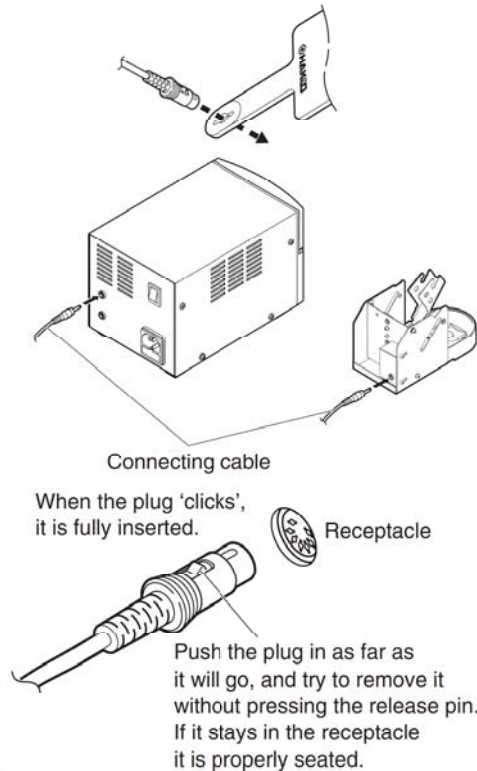

6. OPERATION

● Controls and displays

Refer to the HAKKO FM-203 or FM-206 instruction manual.

NOTE:

The HAKKO FM-203 has 2 channels; D and S channel. The MODEL FM-2023 can be connected to only the D channel.
The HAKKO FM-206 has 3 channels: 1, 2 and 3 channel. The MODEL FM-2023 can be connected to only the channel 2.
Refer to the HAKKO FM-203/FM-206 instruction manual for details of operating.

● Displays

1. Insert the tips:

Hold the head part of the tip with the heat resistant pad and insert the tip into the handpiece. Push until the tip stops. Repeat for second tip.

NOTE:

The tips are a set of 2 pieces with the same tip style. They must be used together.

2. Turn the power switch ON.

3. When the set temperature is reached, the buzzer sounds .

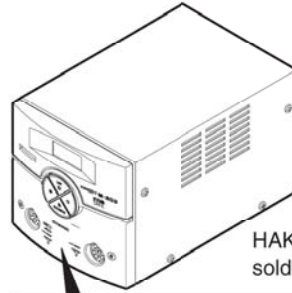

HAKKO FM-203 soldering station

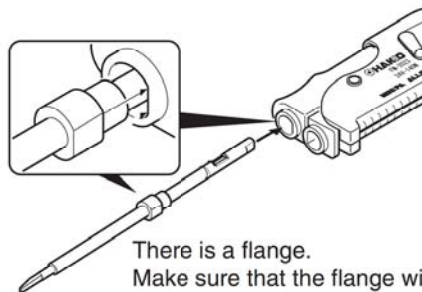
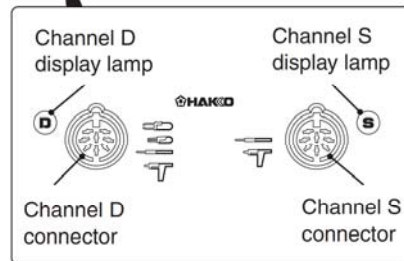

There is a flange.
Make sure that the flange will fit the handle when inserted into the handpiece.

● Operating instructions

1. Set the Temperature

⚠ CAUTION:

Never set the temperature to any value over 400°C (750°F). Doing so may damage the station. Set the temperature according to the type of work to be done.

2. Switch lever on the handle

The FM-2023 is double acting.

- When the tips are touching - i.e. the handpiece is closed- an 'R' is visible on the handle. Operate by squeezing the movable part of the handle at the back.
- When the handpiece is open, an 'N' is visible on the handle. Operate by squeezing the movable part of the handle at the front.

3. Apply solder or flux

If there is insufficient solder on the PWB, or the soldered area is too small, apply solder or flux to the PWB. Solder may also be applied to the tips.

4. Melt the solder

Place the tips on the soldered part and melt the solder. Confirm that the solder is fully melted. See sketch 'A'.

5. Remove the component

After confirming that the solder is fully melted, lightly squeeze the handpiece to grasp the component and lift to remove the component. See sketch 'B'.

Place the desoldered chip onto the tray keeping the tips in parallel, and open them to release.

NOTE:

Once the two tips are inserted into the handpiece, heat control begins. Both tips of the set must be inserted or the handpiece will not heat.

⚠ CAUTION:

Very high tip temperatures may damage the printed circuit board, possibly causing the printed pattern to become detached. HAKKO recommends setting the tip temperature below 300°C (572°F) for all normal work. Using the lowest possible effective temperature not only helps protect parts that are sensitive to heat, it also helps protect the tip from deterioration caused by heat.

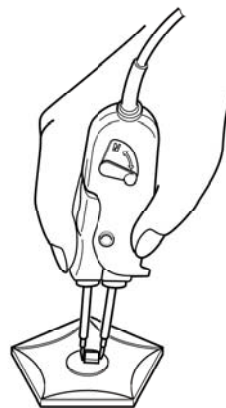
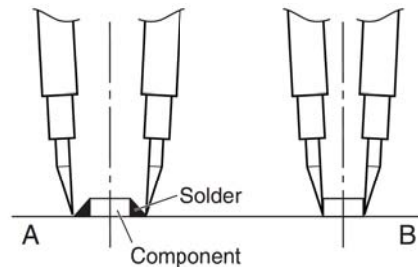

● Control card and changing the temperature setting

Please refer to the HAKKO FM-203 or FM-206 Instruction manual.

● Replacing the tip

Removing and inserting the tip:

Removing the tip:

Hold the handle and pull the tip out of the handpiece with the heat resistant pad.

Inserting the tip:

Before inserting the tip; Insert the Tip ID number key into the process gate until the buzzer sounds once.

Hold head part and insert the tip into the handpiece. Push until the tip stops.

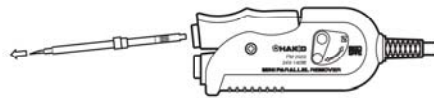

Hold the handpiece at the front to remove tip.

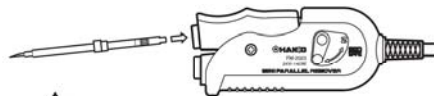

Hold this part to insert into the handpiece.

⚠ CAUTION:

The tip can be very HOT. Use the heat resistant pad for handling hot tips, but do not hold the hot portion of the tip, even with the pad, for longer than necessary.

7. MAINTENANCE

● Tip maintenance

Please refer to the HAKKO FM-203 or FM-206 Instruction manual.

● Checking Procedure

⚠ WARNING:

Unless otherwise directed, carry out these procedures with the power switch OFF and the power UNPLUGGED.

- Verify the electrical integrity of the heater and sensor

1. Check for a broken heater or sensor

Measure the resistance across the tip as shown.

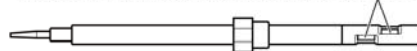

Measure the resistance while at room temperature (15 to 25°C; 59 to 77°F). It should be $8\Omega \pm 10\%$. If the resistance exceeds these limits, replace the tip.

- Check the grounding line

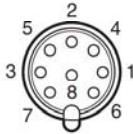

1. Unplug the connection cord from the station.
2. Measure the resistance value between pin 2 and the tip (both tips).
3. If the resistance value is higher than 2Ω (at room temperature), remove the black oxide or replace the tip with a new one. If the resistance value still does not decrease, check the connection cord for breakage.

- Checking the connection cord for breakage

1. Insert a set of verified tips in both sides of the handle.
2. Measure the resistance value between two pins.

Pin 1 - Pin 3	7~9 Ω
Pin 5 - Pin 3	8~10K Ω
Pin 7 - Pin 4	7~9 Ω
Pin 8 - Pin 4	8~10K Ω

If the measured value exceeds above values, replace the FM-2023.

8. TROUBLESHOOTING GUIDE



WARNING:

Disconnect the power plug before servicing.
Failure to do so may result in electric shock.

- **The tip does not heat up.**

- The sensor error **S-E** is displayed.

- **Solder does not wet the tip.**

- **The tip temperature is too high.**

- **The tip temperature is too low.**

- **The soldering iron error **L-E** is displayed.**

- The LED heater lamp does not light.

CHECK : Is the tip inserted properly?

ACTION : Insert the tip completely.

CHECK : Is the connection cord and/or the heater/sensor broken?

ACTION : See the appropriate section of this manual regarding how to check the connection cord and/or the heater/sensor for breakage.

CHECK : Is the tip temperature too high?

ACTION : Set the appropriate temperature.

CHECK : Is the tip contaminated with oxide?

ACTION : Remove the oxide by cleaning the tip on a damp sponge or HAKKO 599B tip cleaner.

CHECK : Is the connection cord broken?

ACTION : See "Checking the connection cord for breakage".

CHECK : Is the tip contaminated with oxide?

ACTION : Remove the oxide by cleaning the tip on a damp sponge or HAKKO 599B tip cleaner.

CHECK : Is the connection cord broken?

ACTION : See "Checking the connection cord for breakage".

CHECK : Is the MODEL FM-2023 plug disconnected?

ACTION : Connect the MODEL FM-2023.

-
- The low-temperature alarm tolerance error **H-E** occurs frequently.

- Heater terminal short circuit error **HSE** is displayed.

- The tips cannot be closed.

- The tips will not return to the original position.

- Tip error **--1** or **--2** is displayed.

CHECK : Is the tip too small for the items to be removed?

ACTION : Use a tip with a large thermal capacity.

CHECK : Is the setting value for the low temperature alarm tolerance too low?

ACTION : Increase the setting value.

CHECK : Is the tip for MODEL FM-2023?

ACTION : Turn the power switch OFF and insert the correct MODEL FM-2023 tip. Turn the power switch ON.

CHECK : Is there a foreign object between the tips?

ACTION : Remove it.

ACTION : Contact your Hakko representative.

9. PARTS LIST

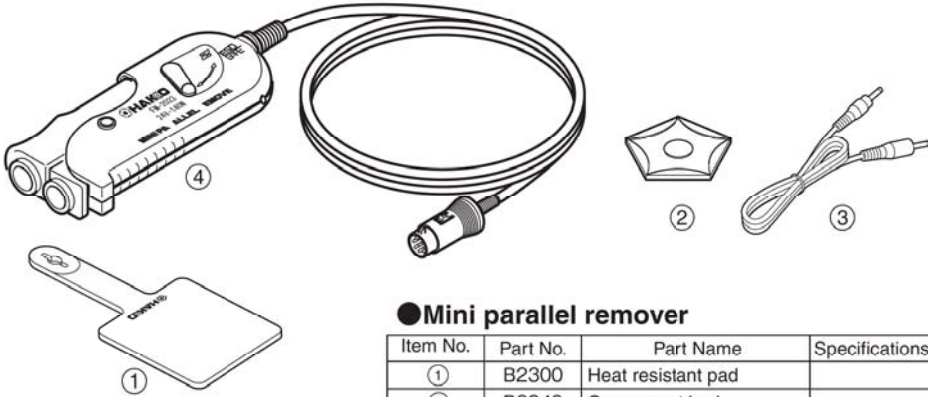

● Mini parallel remover

Item No.	Part No.	Part Name	Specifications
①	B2300	Heat resistant pad	
②	B2849	Component bed	
③	B3253	Connecting cable	
④	FM2023-02	Handpiece only	w/o tip

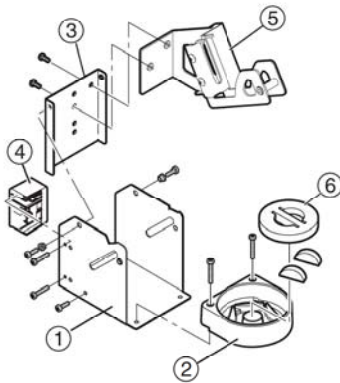

● Iron holder

Item No.	Part No.	Part Name	Specifications
① - ⑥	FH200-04	Iron holder	With cleaning sponge

● Iron holder parts

Item No.	Part No.	Part Name	Specifications
①	B3251	Iron holder base	With rubber feet
②	B3249	Cleaner base	
③	B3250	Stay	
④	B3252	Switch case assembly	
⑤	B3412	Iron holder (assembly)	With screws
⑥	A1536	Cleaning sponge	Green

● Tips

Part No.	Part Name	Size A	Shape
T9-I	Tip/CHIP I	-----	
T9-L1	Tip/CHIP 1L	1 mm	
T9-L2	Tip/CHIP 2L	2 mm	

* The temperature accuracy of the above iron tips is $\pm 15^{\circ}\text{C}$ ($\pm 27^{\circ}\text{F}$).

10. WIRING DIAGRAM

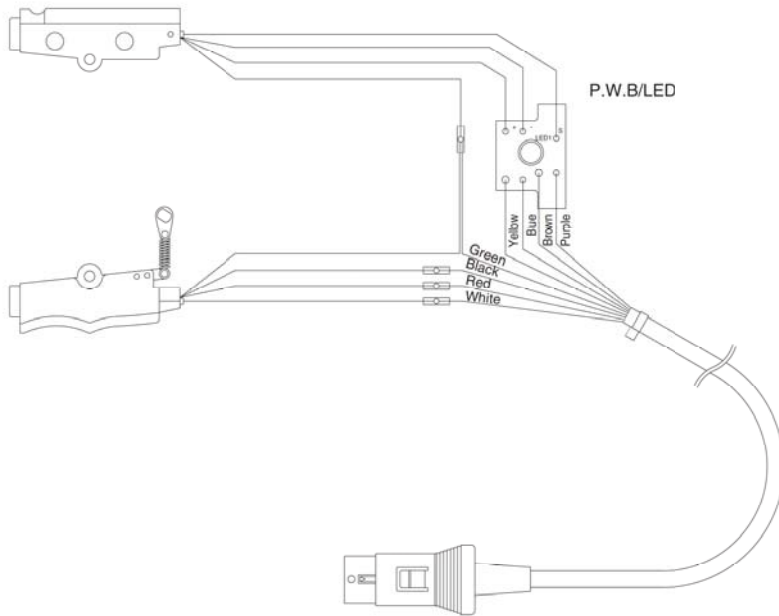

※ 各言語（日本語、英語、中国語、フランス語、ドイツ語、韓国語）の取扱説明書は以下のURL、HAKKO Document Portalからダウンロードしてご覧いただけます。
（商品によっては設定の無い言語がありますが、ご了承ください）

- * 各国語言(日語,英語,中文,法語,德語,韓語)的使用說明書可以通過以下網站的HAKKO Document Portal 下載參閱。
(有一部分的產品沒有設定外語對應,請見諒)
- Instruction manual in the language of Japanese, English, Chinese, French, German and Korean can be downloaded from the HAKKO Document Portal.
(Please note that some languages may not be available depending on the product.)

<https://doc.hakko.com>



HAKKO CORPORATION

HEAD OFFICE

4-5, SHIOKUSA 2-CHOME, NANIWA-KU, OSAKA, 556-0024 JAPAN

TEL:+81-6-6561-3225 FAX:+81-6-6561-8466

<http://www.hakko.com>

AMERICAN HAKKO PRODUCTS, INC.

28920 N. AVENUE WILLIAMS VALENCIA CA 91355, U.S.A.

TEL: (661) 294-0090 FAX: (661) 294-0096

Toll Free (800)88-HAKKO www.hakkousa.com