



Chipsmall Limited consists of a professional team with an average of over 10 year of expertise in the distribution of electronic components. Based in Hongkong, we have already established firm and mutual-benefit business relationships with customers from,Europe,America and south Asia,supplying obsolete and hard-to-find components to meet their specific needs.

With the principle of “Quality Parts,Customers Priority,Honest Operation,and Considerate Service”,our business mainly focus on the distribution of electronic components. Line cards we deal with include Microchip,ALPS,ROHM,Xilinx,Pulse,ON,Everlight and Freescale. Main products comprise IC,Modules,Potentiometer,IC Socket,Relay,Connector.Our parts cover such applications as commercial,industrial, and automotives areas.

We are looking forward to setting up business relationship with you and hope to provide you with the best service and solution. Let us make a better world for our industry!



Contact us

Tel: +86-755-8981 8866 Fax: +86-755-8427 6832

Email & Skype: info@chipsmall.com Web: www.chipsmall.com

Address: A1208, Overseas Decoration Building, #122 Zhenhua RD., Futian, Shenzhen, China



$V_{RM} = 200\text{ V}$, $I_F = 5\text{ A}$, 10 A , 15 A
Fast Recovery Diode Built-in Temperature Detection
FMKS Series



Data Sheet

Description

The FMKS Series is the fast recovery diode built-in temperature detection.

A fast recovery diode and a Schottky barrier diode for temperature detection are formed on the same die. Thus, the FMKS Series achieves highly accurate temperature detection that is higher than that with a thermistor, component reduction, power supply downsizing, and easy attachment.

Features

- Built-in temperature detection
- Highly accurate temperature detection of FRD
- Component reduction of temperature detection
- High speed switching
- Low forward voltage drop

Typical Application

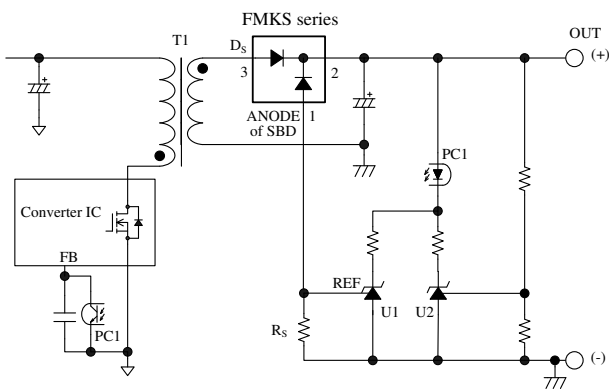

Package

TO220F-3L

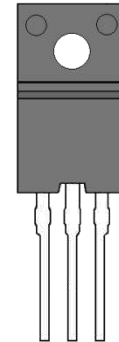

(1)(2)(3)

Not to scale

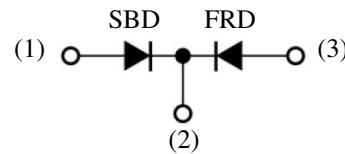

- (1) Anode of Schottky barrier diode, SBD, for temperature detection
- (2) Cathode
- (3) Anode of fast recovery diode, FRD

FMKS Series

Products	V_{RM}	I_F	V_F	t_r
FMKS-2052	200 V	5 A	0.98 V	50 ns
FMKS-2102		10 A		
FMKS-2152		15 A		

where,
 V_{RM} is peak reverse voltage,
 I_F is average forward current,
 V_F is forward voltage drop, and
 t_r is reverse recovery time

Application

The following with thermal protection circuit and peak power limiting circuit, and so forth

- Audio
- White goods
- Power Supplies

CONTENTS

Description ----- 1

CONTENTS ----- 2

1. Absolute Maximum Ratings ----- 3

2. Electrical Characteristics ----- 4

3. Performance Curves ----- 5

 3.1 Schottky Barrier Diode for Temperature Detection Diode Characteristics ----- 5

 3.2 Fast Recovery Diode Characteristics ----- 6

 3.2.1 FMKS-2052 ----- 6

 3.2.2 FMKS-2102 ----- 8

 3.2.3 FMKS-2152 ----- 9

4. External Dimensions ----- 11

5. Marking Diagram ----- 11

6. Temperature Detection Application of FMKS Series ----- 12

IMPORTANT NOTES ----- 14

FMKS Series

1. Absolute Maximum Ratings

Unless specifically noted $T_A = 25\text{ }^\circ\text{C}$.

Parameter	Symbol	Conditions	Rating	Unit	Note
Fast Recovery Diode (FRD)					
Transient Peak Reverse Voltage	V_{RSM}		200	V	
Peak Repetitive Reverse Voltage	V_{RM}		200	V	
Average Forward Current	$I_{F(AV)}$		5	A	FMKS-2052
			10		FMKS-2102
			15		FMKS-2152
Surge Forward Current	I_{FSM}	10 ms, half sine wave, one shot	100	A	FMKS-2052
			140		FMKS-2102
			170		FMKS-2152
I^2t Limiting Value	I^2t	$1\text{ ms} \leq t \leq 10\text{ ms}$	50	A^2s	FMKS-2052
			98		FMKS-2102
			144.5		FMKS-2152
Junction Temperature	T_j		-40 to 150	$^\circ\text{C}$	
Storage Temperature	T_{stg}		-40 to 150	$^\circ\text{C}$	
Isolation Voltage	-	Between the case and each pin, 1 minute, ac	1.0	kV	
Schottky Barrier Diode for Temperature Detection (SBD)					
Transient Peak Reverse Voltage	V_{RSM}		90	V	
Peak Repetitive Reverse Voltage	V_{RM}		90	V	
Junction Temperature	T_j		-40 to 150	$^\circ\text{C}$	
Storage Temperature	T_{stg}		-40 to 150	$^\circ\text{C}$	

FMKS Series

2. Electrical Characteristics

Unless specifically noted $T_A = 25\text{ }^\circ\text{C}$.

Parameter	Symbol	Conditions	Min.	Typ.	Max.	Unit	Note
Fast Recovery Diode (FRD)							
Forward Voltage Drop	V_F	$I_F = 5\text{ A}$	–	–	0.98	V	FMKS-2052
		$I_F = 10\text{ A}$	–	–	0.98		FMKS-2102
		$I_F = 15\text{ A}$	–	–	0.98		FMKS-2152
Reverse Leakage Current	I_R	$V_R = V_{RM}$	–	–	50	μA	FMKS-2052
			–	–	100		FMKS-2102
			–	–	150		FMKS-2152
Reverse Leakage Current Under High Temperature	$H \cdot I_R$	$V_R = V_{RM}$ $T_j = 150\text{ }^\circ\text{C}$	–	–	3	mA	FMKS-2052
			–	–	6		FMKS-2102
			–	–	10		FMKS-2152
Reverse Recovery Time	t_{rr1}	$I_F = I_{RP} = 100\text{ mA}$, $T_j = 25\text{ }^\circ\text{C}$, 90 % recovery point	–	–	50	ns	
	t_{rr2}	$I_F = 100\text{ mA}$, $I_{RP} = 200\text{ mA}$, $T_j = 25\text{ }^\circ\text{C}$, 75 % recovery point	–	–	35	ns	
Thermal Resistance*	$R_{th(j-c)}$		–	–	4.0	$^\circ\text{C/W}$	
Schottky Barrier Diode for Temperature Detection Diode (SBD)							
Reverse Leakage Current	I_{R1}	$V_R = 15\text{ V}$	–	–	50	μA	
	I_{R2}	$V_R = 90\text{ V}$	–	–	2.0	mA	
Reverse Leakage Current Under High Temperature	$H \cdot I_{R1}$	$V_R = 15\text{ V}$, $T_j = 130\text{ }^\circ\text{C}$	1.20	1.90	2.60	mA	
	$H \cdot I_{R2}$	$V_R = 90\text{ V}$, $T_j = 150\text{ }^\circ\text{C}$	–	–	55	mA	

* $R_{th(j-c)}$ is thermal resistance between junction and case.

3. Performance Curves

3.1 Schottky Barrier Diode for Temperature Detection Diode Characteristics

In Figure 3-1, the reverse voltage of Schottky Barrier Diode for temperature detection (SBD), V_R , is 15V. The temperature of fast recovery diode (FRD) can be estimated by using Figure 3-1.

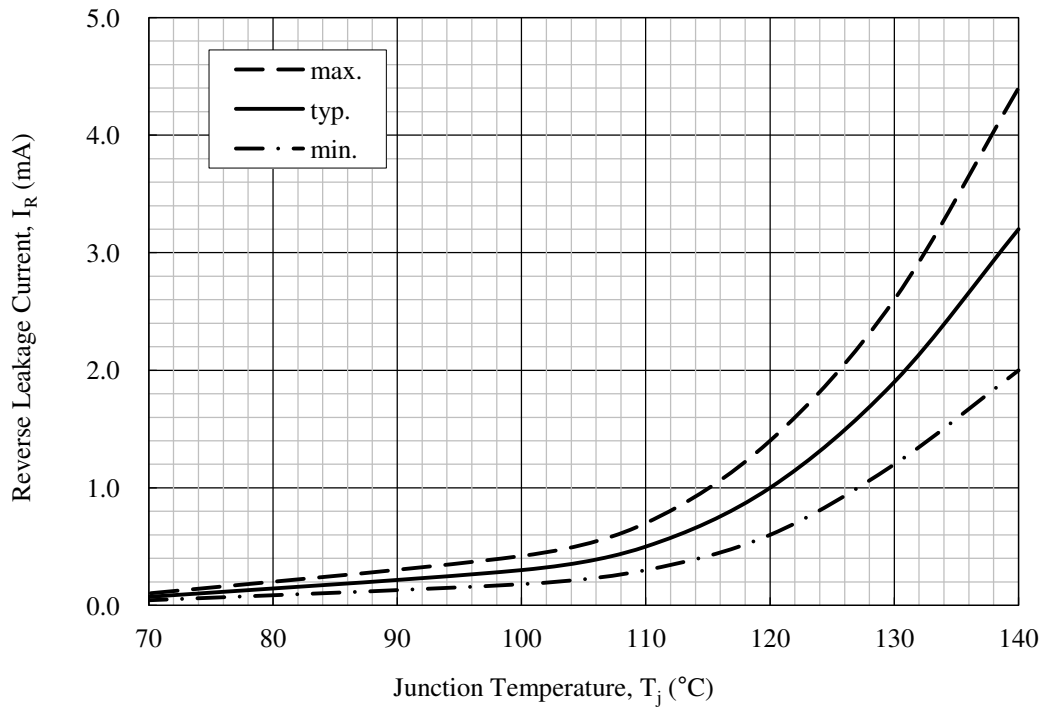

Figure 3-1 Temperature dependent of Reverse Leakage Current, I_R (SBD)

3.2 Fast Recovery Diode Characteristics

T is a pulse cycle, t is a pulse width.

3.2.1 FMKS-2052

3.2.1.1. Typical Characteristics

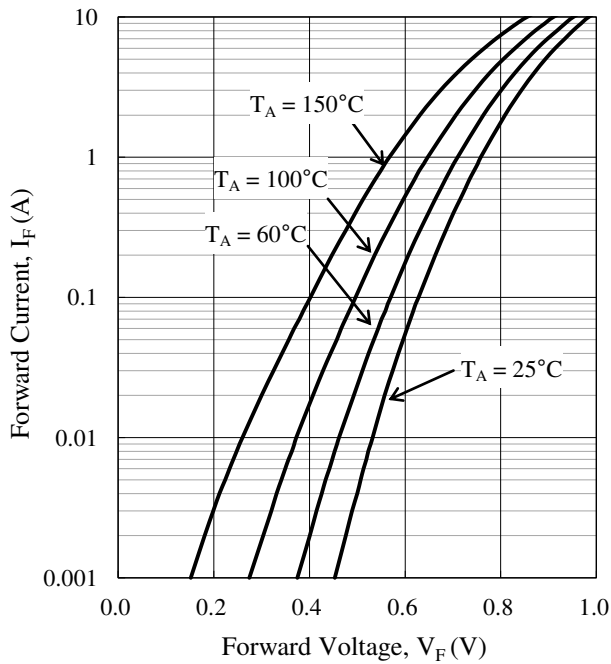

Figure 3-2 $I_F - V_F$ Typical Characteristics

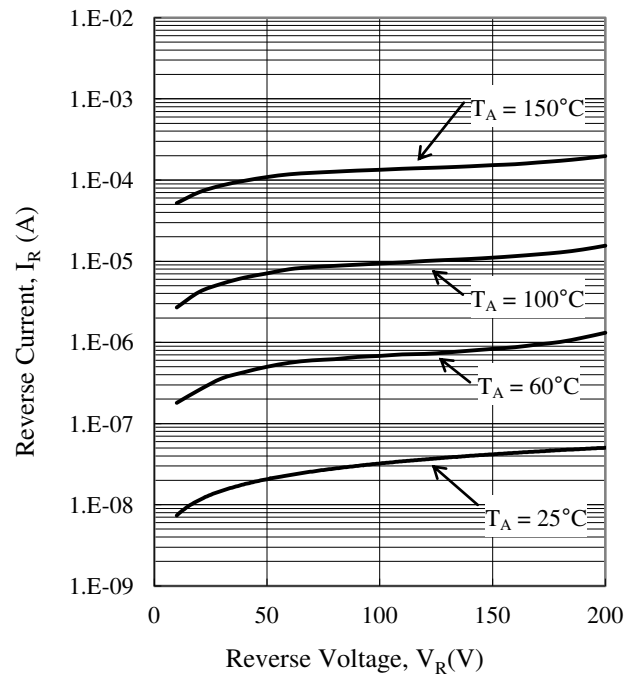

Figure 3-3 $I_R - V_R$ Typical Characteristics

3.2.1.2. Power Dissipation Curves ($T_j = 150\text{ }^\circ\text{C}$)

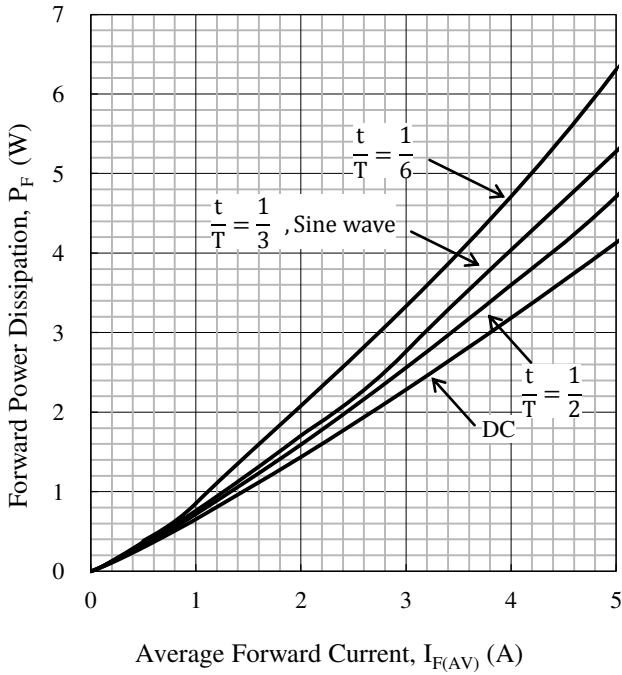

Figure 3-4 $P_F - I_{F(AV)}$

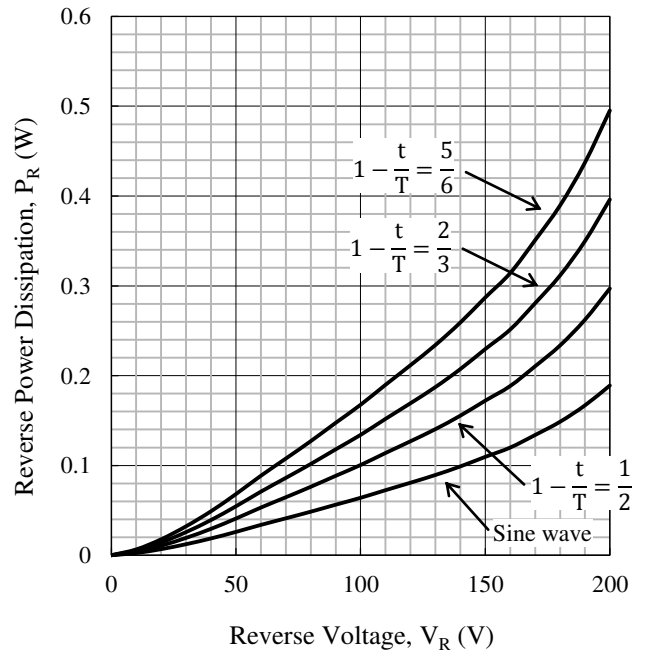

Figure 3-5 $P_R - V_R$

3.2.1.3. Derating Curves ($T_j = 150\text{ }^\circ\text{C}$)

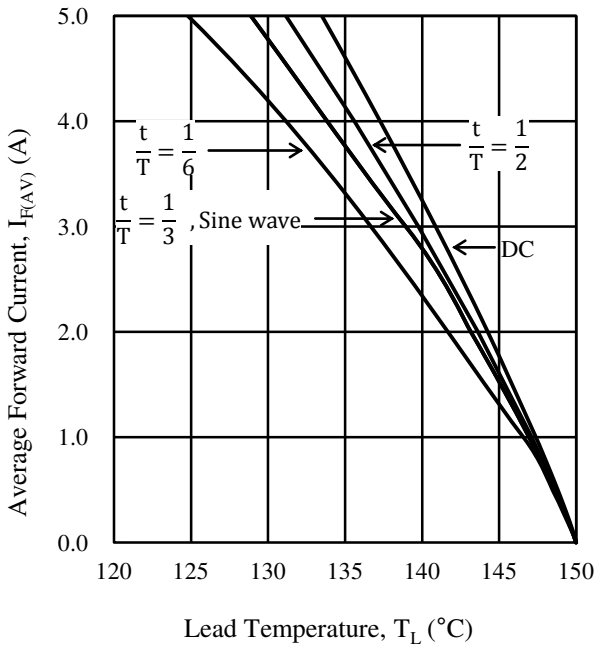

Figure 3-6 $I_{F(AV)} - T_L (V_R = 0\text{ V})$

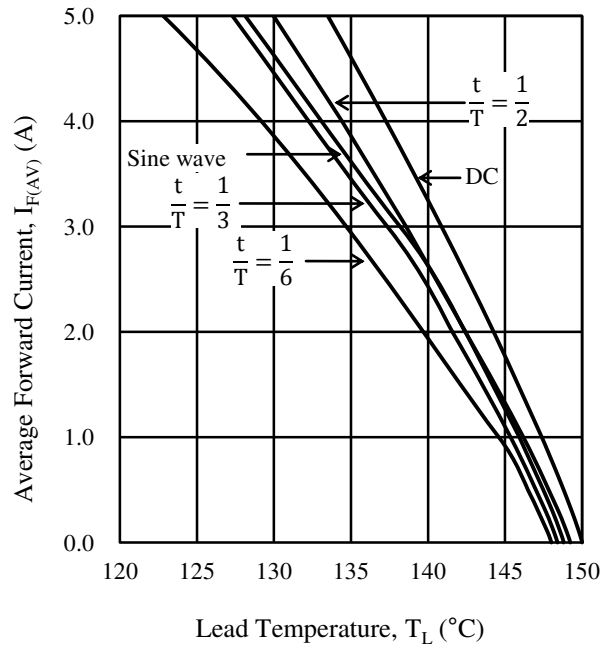

Figure 3-7 $I_{F(AV)} - T_L (V_R = 200\text{ V})$

3.2.2 FMKS-2102

3.2.2.1. Typical Characteristics

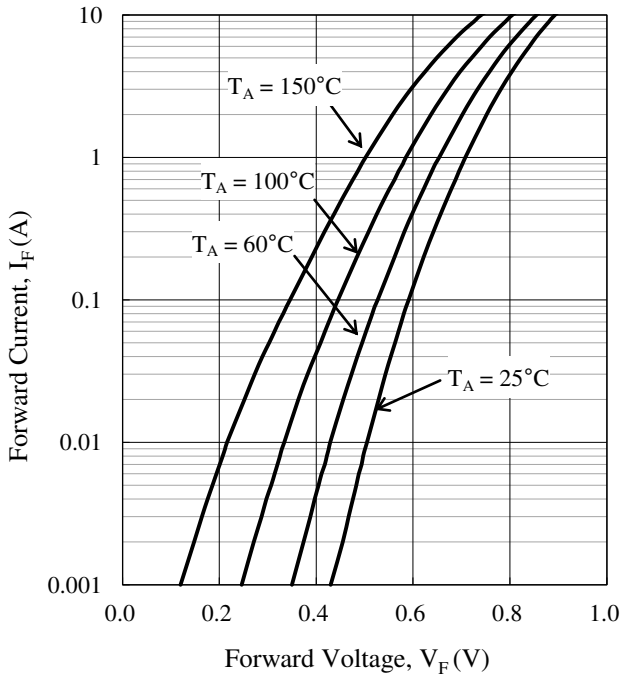

Figure 3-8 $V_F - I_F$ Typical Characteristics

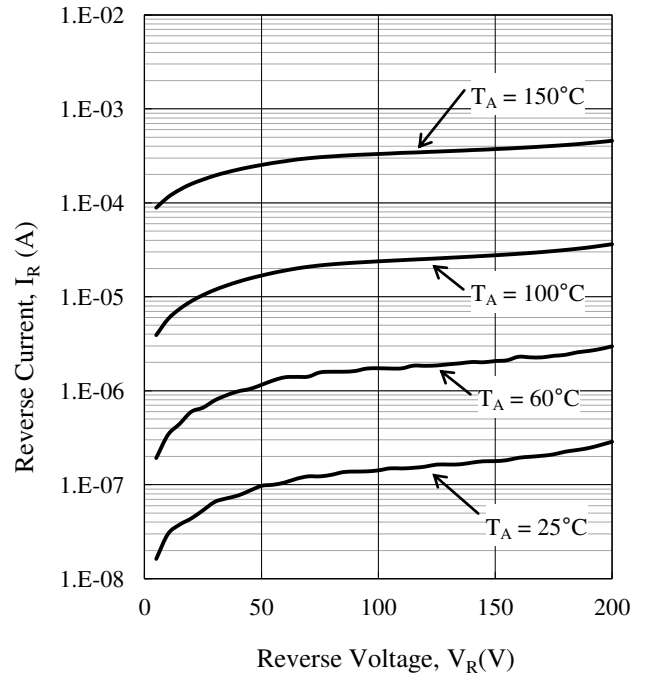

Figure 3-9 $V_R - I_R$ Typical Characteristics

3.2.2.2. Power Dissipation Curves ($T_j = 150^\circ\text{C}$)

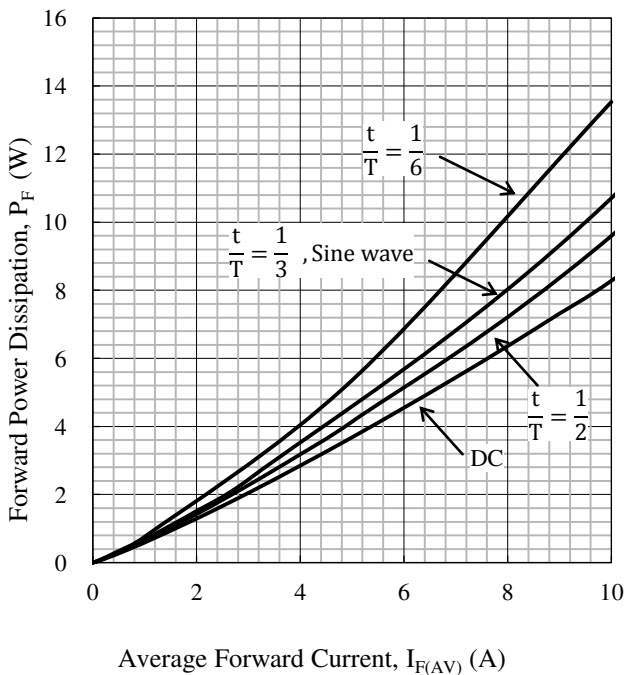

Figure 3-10 $P_F - I_{F(AV)}$

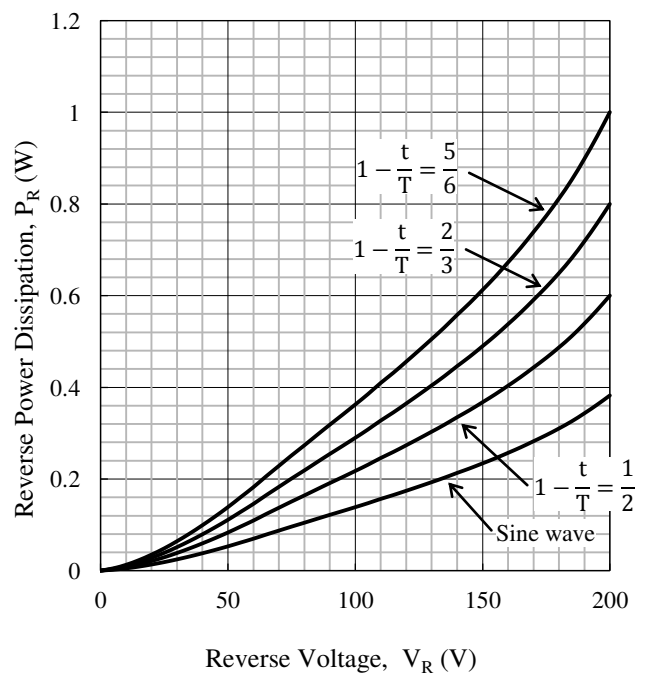

Figure 3-11 $P_R - V_R$

3.2.2.3. Derating Curves ($T_j = 150^\circ\text{C}$)

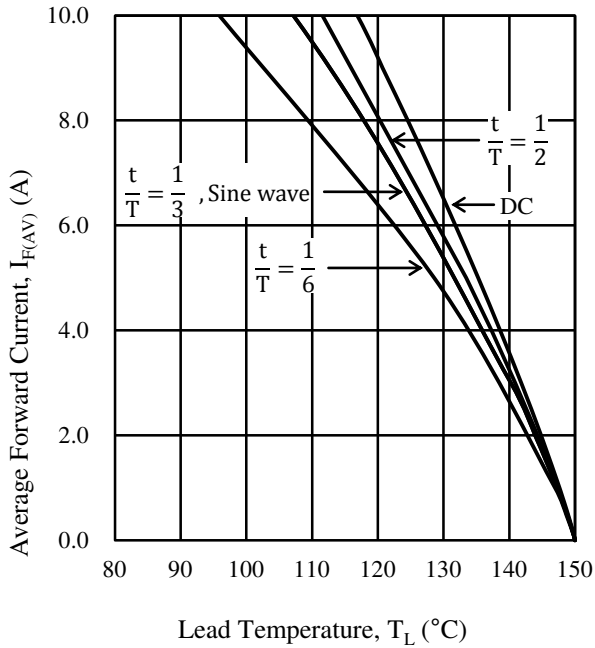

Figure 3-12 $I_{F(AV)} - T_L$ ($V_R = 0\text{ V}$)

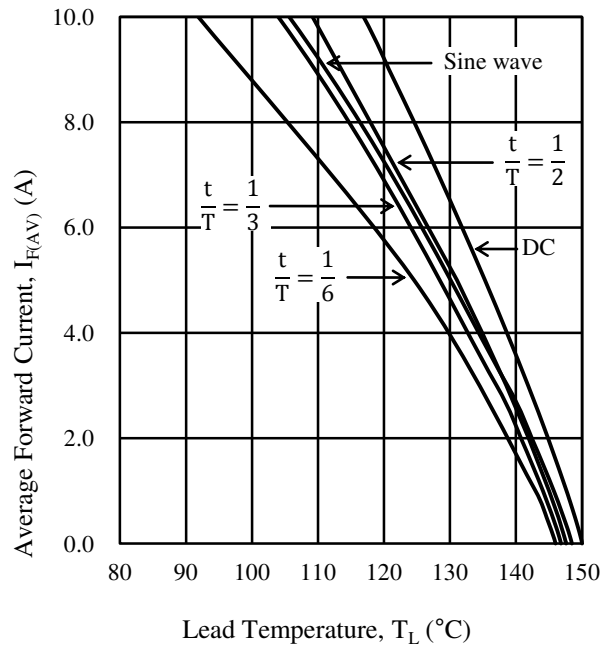

Figure 3-13 $I_{F(AV)} - T_L$ ($V_R = 200\text{ V}$)

3.2.3 FMKS-2152

3.2.3.1. Typical Characteristics

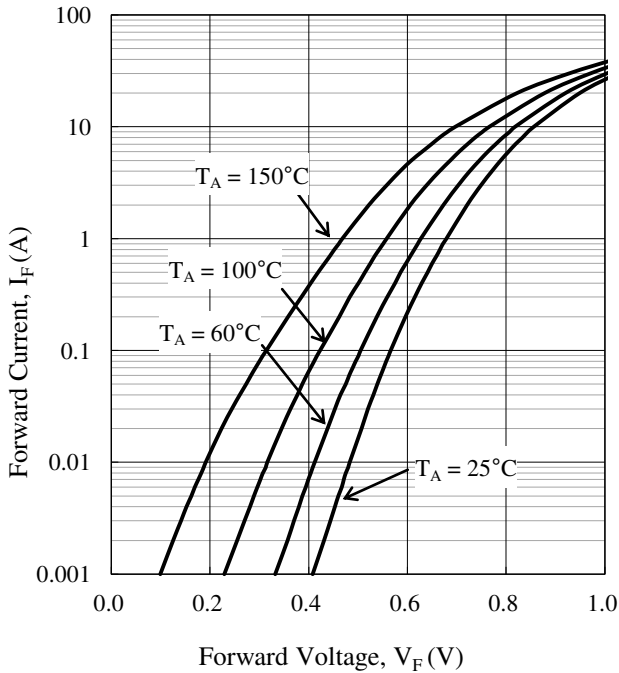

Figure 3-14 $V_F - I_F$ Typical Characteristics

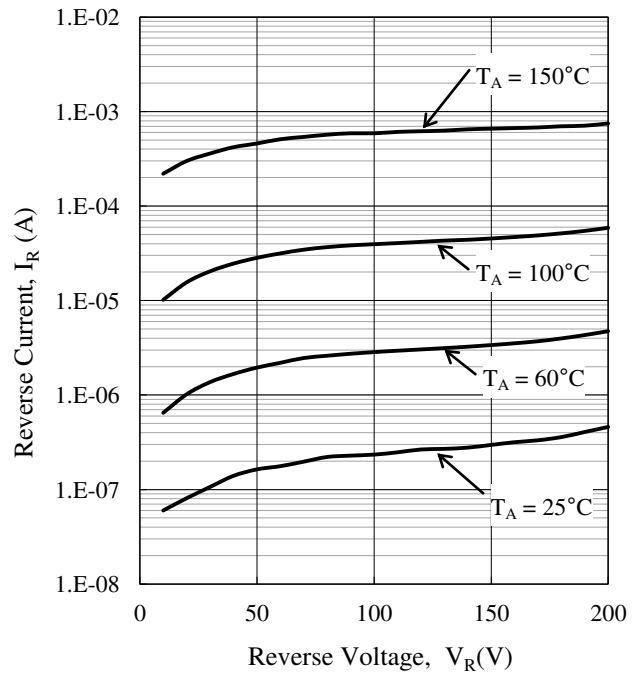

Figure 3-15 $V_R - I_R$ Typical Characteristics

3.2.3.2. Power Dissipation Curves ($T_j = 150\text{ }^\circ\text{C}$)

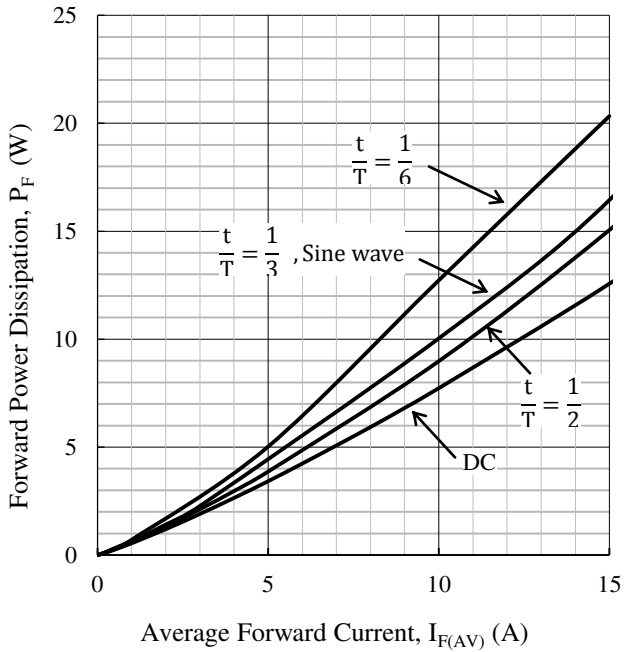

Figure 3-16 $P_F - I_{F(AV)}$

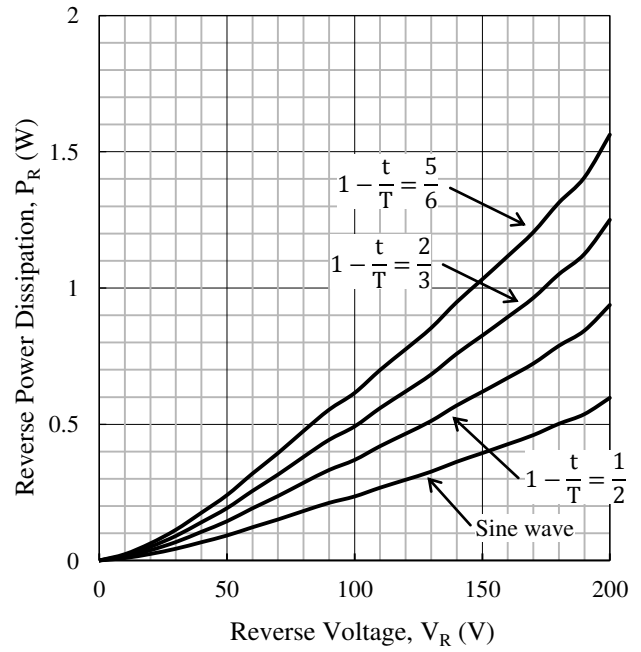

Figure 3-17 $P_R - V_R$

3.2.3.3. Derating Curves ($T_j = 150\text{ }^\circ\text{C}$)

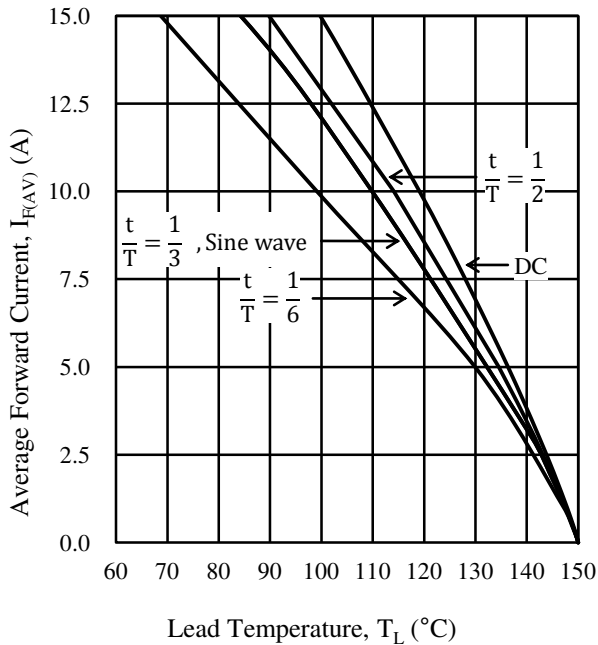

Figure 3-18 $I_{F(AV)} - T_L$ ($V_R = 0\text{ V}$)

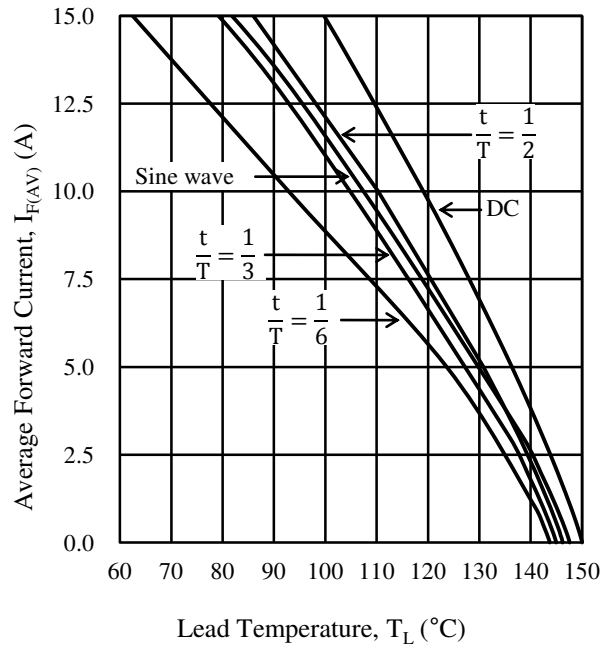
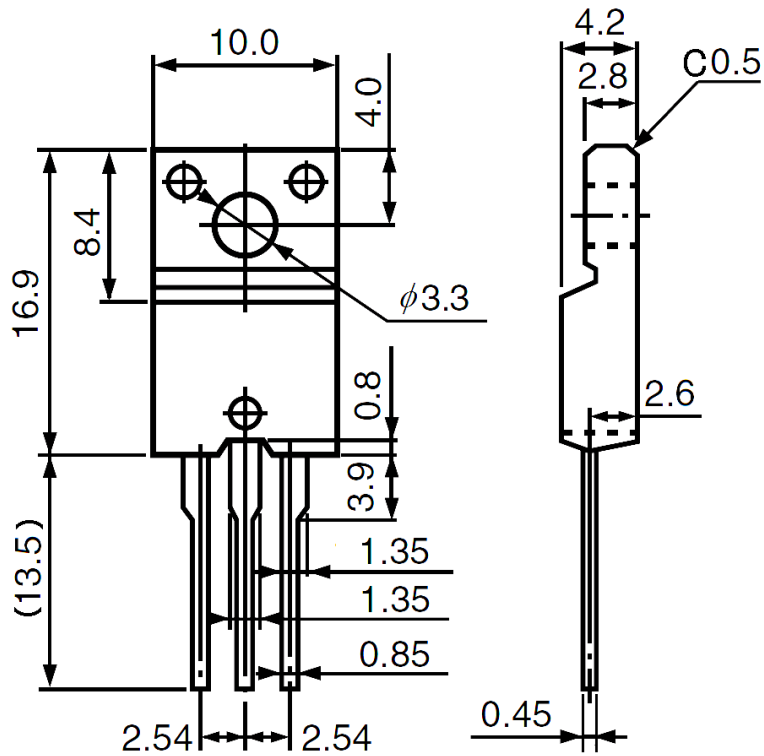

Figure 3-19 $I_{F(AV)} - T_L$ ($V_R = 200\text{ V}$)

4. External Dimensions

TO220F-3L



NOTES:

- Dimension is in millimeters.
- Lead treatment Pb-free. Device composition compliant with the RoHS directive.

5. Marking Diagram

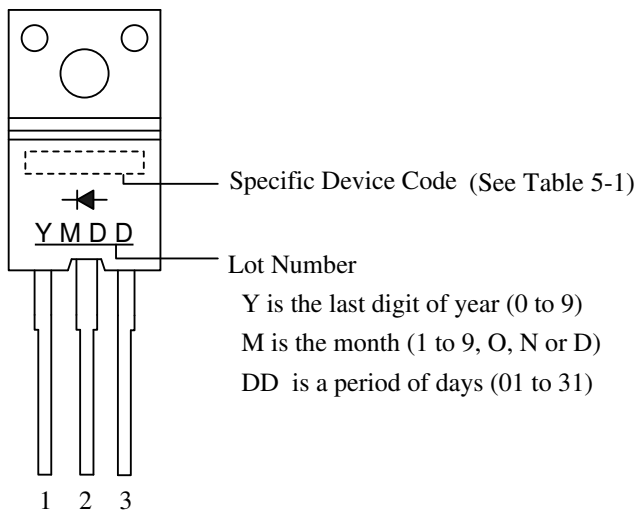

Table 5-1 Specific Device Code

Specific Device Code	Products
KS2052	FMKS-2052
KS2102	FMKS-2102
KS2152	FMKS-2152

6. Temperature Detection Application of FMKS Series

This section shows an example about a temperature detection circuit of a secondary rectifier diode in off-line flyback converters.

Figure 6-1 shows the reference of temperature detection circuit with a NTC thermistor. The NTC thermistor, coupled thermally with D_S secondary rectifier diode, is connected to the REF pin of the output voltage detection circuit in the converter.

As shown in Figure 6-2, as the temperature rises, the resistance of the NTC thermistor decreases.

When the temperature of D_S rises due to such a cause as overload state, the resistance of NTC thermistor decreases, and the ratio of resistance voltage divider is changed. When the voltage of R_S shown in Figure 6-1 reaches the reference voltage of U1 shunt regulator, the current flows to PC1 optocoupler, and the converter IC in the primary limits the output power. Thus, the rise of D_S temperature can be limited.

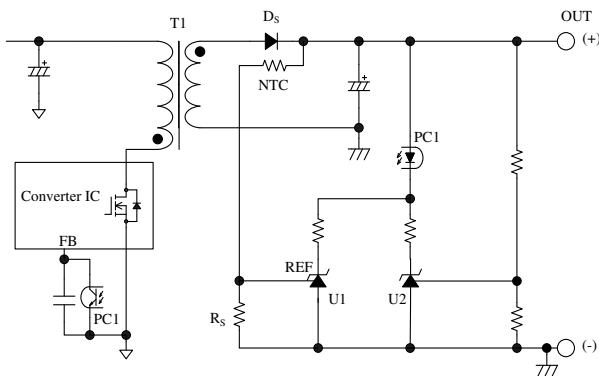

Figure 6-1 Reference temperature detection circuit with NTC thermistor

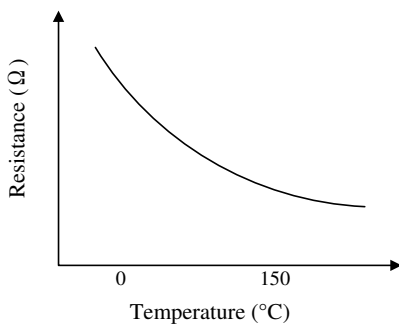

Figure 6-2 Reference characteristics of NTC thermistor

The temperature detection circuit with thermistor has the following issues.

- Since some attachment distance occurs between the thermistor and D_S , the accurate temperature of D_S cannot be detected.
- Thermistor cannot follow the rapid temperature change.

- Increasing the accuracy of temperature detection by reducing the thermal resistance between D_S and the thermistor, it is necessary to attach the thermistor to D_S with high thermal conductivity material between them.

In contrast with the temperature detection of thermistor, the FMKS series can achieve high accuracy of temperature detection by the following.

- The internal structure is formed a Schottky barrier diode for temperature detection, SBD, and a fast recovery diode, FRD, on the same die as shown in Figure 6-3. Thus, the temperature is about the same between SBD and FRD.
- The temperature detection uses the temperature characteristics of the leakage current for SBD, which increases as the temperature rises as shown in Figure 6-4.

The temperature detection circuit with FMKS series has the following advantages.

- Highly accurate and stable temperature detection of FRD.
- Real time temperature detection of FRD.
- Circuit component reduction such as thermistor, and easy attachment.
- Power supply downsizing.

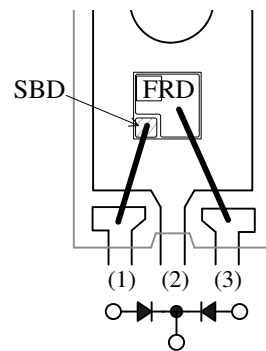

Figure 6-3 Internal structure of FMKS series

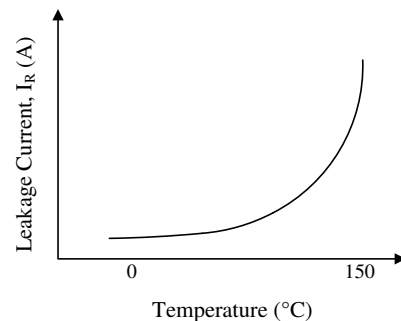

Figure 6-4 Reference temperature characteristics of SBD leakage current

IMPORTANT NOTES

- All data, illustrations, graphs, tables and any other information included in this document as to Sanken's products listed herein (the "Sanken Products") are current as of the date this document is issued. All contents in this document are subject to any change without notice due to improvement, etc. Please make sure that the contents set forth in this document reflect the latest revisions before use.
- The Sanken Products are intended for use as components of general purpose electronic equipment or apparatus (such as home appliances, office equipment, telecommunication equipment, measuring equipment, etc.). Prior to use of the Sanken Products, please put your signature, or affix your name and seal, on the specification documents of the Sanken Products and return them to Sanken. If considering use of the Sanken Products for any applications that require higher reliability (transportation equipment and its control systems, traffic signal control systems or equipment, disaster/crime alarm systems, various safety devices, etc.), you must contact a Sanken sales representative to discuss the suitability of such use and put your signature, or affix your name and seal, on the specification documents of the Sanken Products and return them to Sanken, prior to the use of the Sanken Products. Any use of the Sanken Products without the prior written consent of Sanken in any applications where extremely high reliability is required (aerospace equipment, nuclear power control systems, life support systems, etc.) is strictly prohibited.
- In the event of using the Sanken Products by either (i) combining other products or materials therewith or (ii) physically, chemically or otherwise processing or treating the same, you must duly consider all possible risks that may result from all such uses in advance and proceed therewith at your own responsibility.
- Although Sanken is making efforts to enhance the quality and reliability of its products, it is impossible to completely avoid the occurrence of any failure or defect in semiconductor products at a certain rate. You must take, at your own responsibility, preventative measures including using a sufficient safety design and confirming safety of any equipment or systems in/for which the Sanken Products are used, upon due consideration of a failure occurrence rate or derating, etc., in order not to cause any human injury or death, fire accident or social harm which may result from any failure or malfunction of the Sanken Products. Please refer to the relevant specification documents and Sanken's official website in relation to derating.
- No anti-radioactive ray design has been adopted for the Sanken Products.
- No contents in this document can be transcribed or copied without Sanken's prior written consent.
- The circuit constant, operation examples, circuit examples, pattern layout examples, design examples, recommended examples and evaluation results based thereon, etc., described in this document are presented for the sole purpose of reference of use of the Sanken Products and Sanken assumes no responsibility whatsoever for any and all damages and losses that may be suffered by you, users or any third party, or any possible infringement of any and all property rights including intellectual property rights and any other rights of you, users or any third party, resulting from the foregoing.
- All technical information described in this document (the "Technical Information") is presented for the sole purpose of reference of use of the Sanken Products and no license, express, implied or otherwise, is granted hereby under any intellectual property rights or any other rights of Sanken.
- Unless otherwise agreed in writing between Sanken and you, Sanken makes no warranty of any kind, whether express or implied, as to the quality of the Sanken Products (including the merchantability, or fitness for a particular purpose or a special environment thereof), and any information contained in this document (including its accuracy, usefulness, or reliability).
- In the event of using the Sanken Products, you must use the same after carefully examining all applicable environmental laws and regulations that regulate the inclusion or use of any particular controlled substances, including, but not limited to, the EU RoHS Directive, so as to be in strict compliance with such applicable laws and regulations.
- You must not use the Sanken Products or the Technical Information for the purpose of any military applications or use, including but not limited to the development of weapons of mass destruction. In the event of exporting the Sanken Products or the Technical Information, or providing them for non-residents, you must comply with all applicable export control laws and regulations in each country including the U.S. Export Administration Regulations (EAR) and the Foreign Exchange and Foreign Trade Act of Japan, and follow the procedures required by such applicable laws and regulations.
- Sanken assumes no responsibility for any troubles, which may occur during the transportation of the Sanken Products including the falling thereof, out of Sanken's distribution network.
- Although Sanken has prepared this document with its due care to pursue the accuracy thereof, Sanken does not warrant that it is error free and Sanken assumes no liability whatsoever for any and all damages and losses which may be suffered by you resulting from any possible errors or omissions in connection with the contents included herein.
- Please refer to the relevant specification documents in relation to particular precautions when using the Sanken Products, and refer to our official website in relation to general instructions and directions for using the Sanken Products.