



Chipsmall Limited consists of a professional team with an average of over 10 year of expertise in the distribution of electronic components. Based in Hongkong, we have already established firm and mutual-benefit business relationships with customers from,Europe,America and south Asia,supplying obsolete and hard-to-find components to meet their specific needs.

With the principle of "Quality Parts,Customers Priority,Honest Operation,and Considerate Service",our business mainly focus on the distribution of electronic components. Line cards we deal with include Microchip,ALPS,ROHM,Xilinx,Pulse,ON,Everlight and Freescale. Main products comprise IC,Modules,Potentiometer,IC Socket,Relay,Connector.Our parts cover such applications as commercial,industrial, and automotives areas.

We are looking forward to setting up business relationship with you and hope to provide you with the best service and solution. Let us make a better world for our industry!



## Contact us

Tel: +86-755-8981 8866 Fax: +86-755-8427 6832

Email & Skype: info@chipsmall.com Web: www.chipsmall.com

Address: A1208, Overseas Decoration Building, #122 Zhenhua RD., Futian, Shenzhen, China



**FMMT549 / FMMT549A**

**30V PNP SILICON PLANAR HIGH VOLTAGE TRANSISTOR IN SOT23**

**Features and Benefits**

- $BV_{CEO} > -30V$
- Maximum Continuous Collector Current  $I_C = -1A$
- 500mW power dissipation
- Complementary type:
  - FMMT549 – FMMT449
  - FMMT549A – N/A
- **Lead Free, RoHS Compliant (Note 1)**
- **Halogen and Antimony Free "Green" Device (Note 2)**
- **Qualified to AEC-Q101 Standards for High Reliability**

**Mechanical Data**

- Case: SOT23
- UL Flammability Rating 94V-0
- Case material: molded Plastic.
- Moisture Sensitivity: Level 1 per J-STD-020
- Terminals: Matte Tin Finish; Solderable per MIL-STD-202, Method 208
- Weight: 0.008 grams (Approximate)

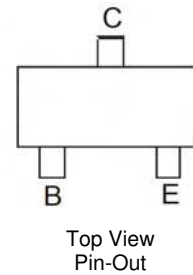
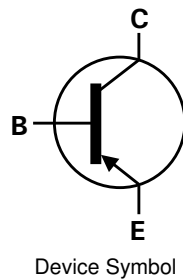

**Ordering Information** (Note 3)

Product	Marking	Reel size (inches)	Tape width (mm)	Quantity per reel
FMMT549TA	549	7	8	3,000
FMMT549ATA	59A	7	8	3,000

- Notes:
1. No purposefully added lead.
  2. Diodes Inc.'s "Green" Policy can be found on our website at <http://www.diodes.com>
  3. For Packaging Details, go to our website at <http://www.diodes.com>.

**Marking Information**

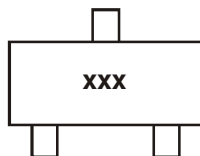

xxx = Product Type Marking Code  
 FMMT549: xxx = 549  
 FMMT549A: xxx = 59A

**FMMT549 / FMMT549A**

**Maximum Ratings** @T<sub>A</sub> = 25°C unless otherwise specified

Characteristic	Symbol	Value	Unit
Collector-Base Voltage	V <sub>CB0</sub>	-35	V
Collector-Emitter Voltage	V <sub>CEO</sub>	-30	V
Emitter-Base Voltage	V <sub>EBO</sub>	-5	V
Continuous Collector Current	I <sub>C</sub>	-1	A
Peak Pulse Current	I <sub>CM</sub>	-2	A
Base Current	I <sub>B</sub>	-200	mA

**Thermal Characteristics** @T<sub>A</sub> = 25°C unless otherwise specified

Characteristic	Symbol	Value	Unit
Power Dissipation (Note 4)	P <sub>D</sub>	500	mW
Thermal Resistance, Junction to Ambient (Note 4)	R <sub>θJA</sub>	250	°C/W
Thermal Resistance, Junction to Lead (Note 5)	R <sub>θJL</sub>	197	°C/W
Operating and Storage Temperature Range	T <sub>J</sub> , T <sub>STG</sub>	-55 to +150	°C

**Electrical Characteristics** @T<sub>A</sub> = 25°C unless otherwise specified

Characteristic	Symbol	Min	Typ	Max	Unit	Test Condition
Collector-Base Breakdown Voltage	BV <sub>CB0</sub>	-35	-	-	V	I <sub>C</sub> = -100μA
Collector-Emitter Breakdown Voltage (Note 6)	BV <sub>CEO</sub>	-30	-	-	V	I <sub>C</sub> = -10mA
Emitter-Base Breakdown Voltage	BV <sub>EBO</sub>	-5	-	-	V	I <sub>E</sub> = -100μA
Collector Cutoff Current	I <sub>CB0</sub>	-	-	-0.1	μA	V <sub>CB</sub> = -30V
		-	-	-10		V <sub>CB</sub> = -30V, T <sub>A</sub> = 100°C
Emitter Cutoff Current	I <sub>EBO</sub>	-	-	-0.1	μA	V <sub>EB</sub> = -4V
Static Forward Current Transfer Ratio (Note 6)	h <sub>FE</sub>	70	200	-	-	I <sub>C</sub> = -50mA, V <sub>CE</sub> = -2V
		80	130	-	-	I <sub>C</sub> = -1A, V <sub>CE</sub> = -2V
		40	80	-	-	I <sub>C</sub> = -2A, V <sub>CE</sub> = -2V
		100	160	300	-	I <sub>C</sub> = -500mA, V <sub>CE</sub> = -2V
	FMMT549A	150	200	500	-	I <sub>C</sub> = -500mA, V <sub>CE</sub> = -2V
Collector-Emitter Saturation Voltage	V <sub>CE(sat)</sub>	-	-250	-500	mV	I <sub>C</sub> = -1A, I <sub>B</sub> = -100mA
		-	-500	-750		I <sub>C</sub> = -2A, I <sub>B</sub> = -200mA
		-	-	-300	mV	I <sub>C</sub> = -100mA, I <sub>B</sub> = -1mA
Base-Emitter Saturation Voltage (Note 6)	V <sub>BE(sat)</sub>	-	-900	-1250	mV	I <sub>C</sub> = -1A, I <sub>B</sub> = -100mA
Base-Emitter Turn-On Voltage (Note 6)	V <sub>BE(on)</sub>	-	-850	-1000	mV	I <sub>C</sub> = -1A, V <sub>CE</sub> = -2V
Output Capacitance	C <sub>obo</sub>	-	-	25	pF	V <sub>CB</sub> = -10V, f = 1MHz
Transition Frequency	f <sub>T</sub>	100	-	-	MHz	V <sub>CE</sub> = -5V, I <sub>C</sub> = -100mA, f = 100MHz
Switching Times	t <sub>on</sub>	-	50	-	ns	I <sub>C</sub> = -500mA, V <sub>CC</sub> = -10V
	t <sub>off</sub>	-	300	-	ns	I <sub>B1</sub> = I <sub>B2</sub> = -50mA

- Notes:
4. For a device surface mounted FR4 PCB with minimum recommended pad layout; high coverage of single sided 1 oz copper, in still air conditions; the device is measured when operating in a steady-state condition.
  5. Thermal resistance from junction to solder-point (at the end of the collector lead).
  6. Measured under pulsed conditions. Pulse width ≤ 300 μs. Duty cycle ≤ 2%



**Typical Electrical Characteristics**

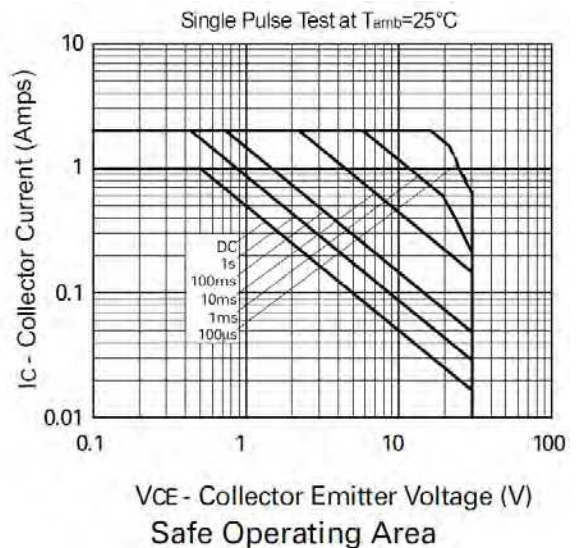
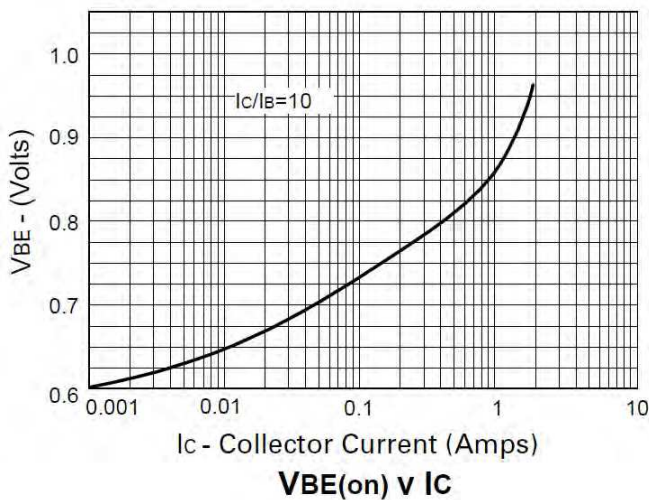
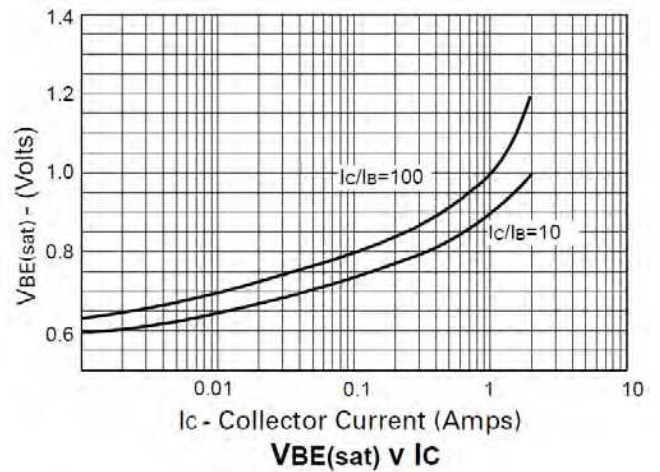
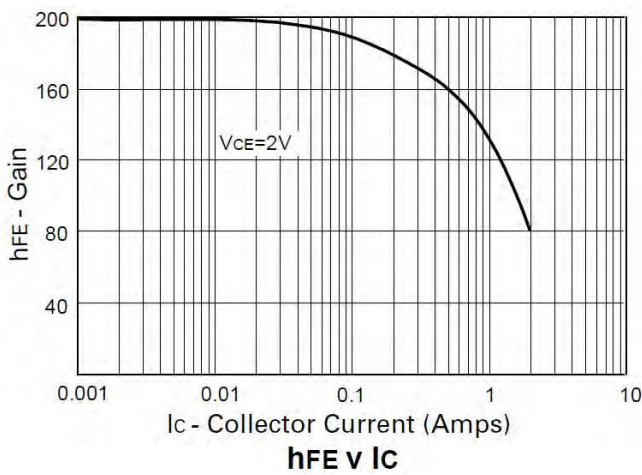
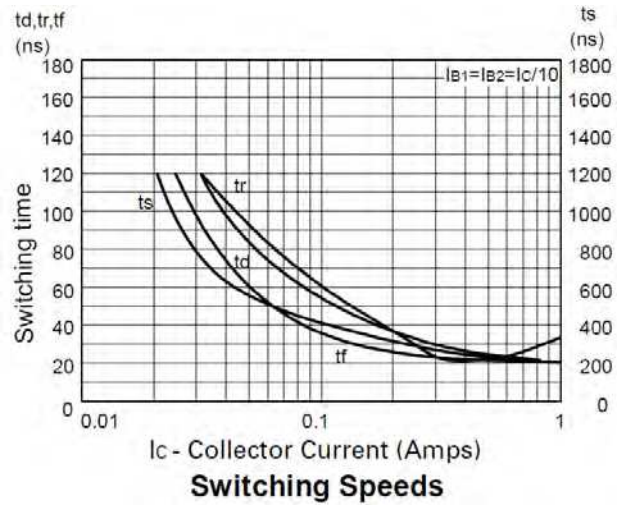
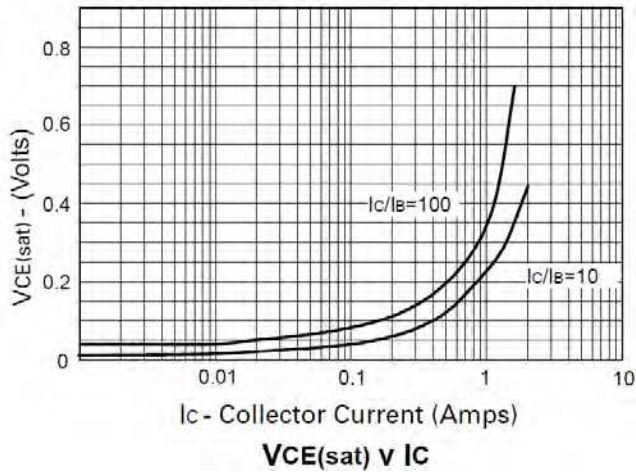

**FMMT549 / FMMT549A**

**Package Outline Dimensions**

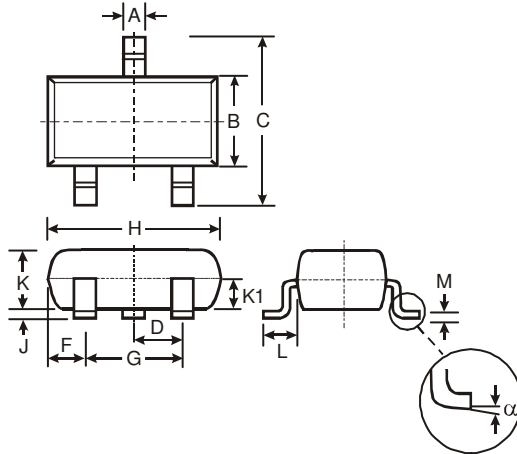

SOT23			
Dim	Min	Max	Typ
A	0.37	0.51	0.40
B	1.20	1.40	1.30
C	2.30	2.50	2.40
D	0.89	1.03	0.915
F	0.45	0.60	0.535
G	1.78	2.05	1.83
H	2.80	3.00	2.90
J	0.013	0.10	0.05
K	0.903	1.10	1.00
K1	-	-	0.400
L	0.45	0.61	0.55
M	0.085	0.18	0.11
α	0°	8°	-
All Dimensions in mm			

**Suggested Pad Layout**

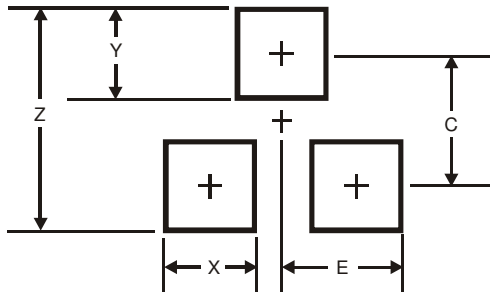

Dimensions	Value (in mm)
Z	2.9
X	0.8
Y	0.9
C	2.0
E	1.35

**IMPORTANT NOTICE**

DIODES INCORPORATED MAKES NO WARRANTY OF ANY KIND, EXPRESS OR IMPLIED, WITH REGARDS TO THIS DOCUMENT, INCLUDING, BUT NOT LIMITED TO, THE IMPLIED WARRANTIES OF MERCHANTABILITY AND FITNESS FOR A PARTICULAR PURPOSE (AND THEIR EQUIVALENTS UNDER THE LAWS OF ANY JURISDICTION).

Diodes Incorporated and its subsidiaries reserve the right to make modifications, enhancements, improvements, corrections or other changes without further notice to this document and any product described herein. Diodes Incorporated does not assume any liability arising out of the application or use of this document or any product described herein; neither does Diodes Incorporated convey any license under its patent or trademark rights, nor the rights of others. Any Customer or user of this document or products described herein in such applications shall assume all risks of such use and will agree to hold Diodes Incorporated and all the companies whose products are represented on Diodes Incorporated website, harmless against all damages.

Diodes Incorporated does not warrant or accept any liability whatsoever in respect of any products purchased through unauthorized sales channel. Should Customers purchase or use Diodes Incorporated products for any unintended or unauthorized application, Customers shall indemnify and hold Diodes Incorporated and its representatives harmless against all claims, damages, expenses, and attorney fees arising out of, directly or indirectly, any claim of personal injury or death associated with such unintended or unauthorized application.

Products described herein may be covered by one or more United States, international or foreign patents pending. Product names and markings noted herein may also be covered by one or more United States, international or foreign trademarks.

**LIFE SUPPORT**

Diodes Incorporated products are specifically not authorized for use as critical components in life support devices or systems without the express written approval of the Chief Executive Officer of Diodes Incorporated. As used herein:

- A. Life support devices or systems are devices or systems which:
1. are intended to implant into the body, or
  2. support or sustain life and whose failure to perform when properly used in accordance with instructions for use provided in the labeling can be reasonably expected to result in significant injury to the user.
- B. A critical component is any component in a life support device or system whose failure to perform can be reasonably expected to cause the failure of the life support device or to affect its safety or effectiveness.

Customers represent that they have all necessary expertise in the safety and regulatory ramifications of their life support devices or systems, and acknowledge and agree that they are solely responsible for all legal, regulatory and safety-related requirements concerning their products and any use of Diodes Incorporated products in such safety-critical, life support devices or systems, notwithstanding any devices- or systems-related information or support that may be provided by Diodes Incorporated. Further, Customers must fully indemnify Diodes Incorporated and its representatives against any damages arising out of the use of Diodes Incorporated products in such safety-critical, life support devices or systems.

Copyright © 2011, Diodes Incorporated

[www.diodes.com](http://www.diodes.com)