



Chipsmall Limited consists of a professional team with an average of over 10 year of expertise in the distribution of electronic components. Based in Hongkong, we have already established firm and mutual-benefit business relationships with customers from,Europe,America and south Asia,supplying obsolete and hard-to-find components to meet their specific needs.

With the principle of "Quality Parts,Customers Priority,Honest Operation,and Considerate Service",our business mainly focus on the distribution of electronic components. Line cards we deal with include Microchip,ALPS,ROHM,Xilinx,Pulse,ON,Everlight and Freescale. Main products comprise IC,Modules,Potentiometer,IC Socket,Relay,Connector.Our parts cover such applications as commercial,industrial, and automotives areas.

We are looking forward to setting up business relationship with you and hope to provide you with the best service and solution. Let us make a better world for our industry!



Contact us

Tel: +86-755-8981 8866 Fax: +86-755-8427 6832

Email & Skype: info@chipsmall.com Web: www.chipsmall.com

Address: A1208, Overseas Decoration Building, #122 Zhenhua RD., Futian, Shenzhen, China



Compact 1-stage filter for 3-phase systems with neutral conductor



See below:

Approvals and Compliances

Description

- Quick-connect terminals 6.3 x 0.8 for three phases, neutral conductor and ground

Applications

- Especially designed for industrial applications such as: Frequency Converters, Stepper Motor Drives, UPS-Systems, Inverters
 - Suitable for use in equipment according to IEC/UL 60950

Weblinks

[pdf datasheet](#), [html-datasheet](#), [General Product Information](#), [Distributor-Stock-Check](#), [Detailed request for product](#), [Microsite](#)

Technical Data

Rated Current	3 - 20A @ Ta 40 °C
Rated voltage	275/480 VAC, 50/60 Hz
Approval for	3 - 20A / 250/440VAC; 50Hz
Overload Current	1.5 x Ir
Leakage Current	industrial < 3mA (440V / 50Hz)
Dielectric Strength	2.25 kVDC between L-L 1.7 kVDC between L-N 3 kVDC between L-PE 2.7 kVDC between N-PE Test voltage (2 sec)
Number of Filter Stages	1-stage
Weight	0.2 - 0.35 kg
Material: Housing	Metal
Sealing Compound	UL 94V-0

Mounting	Screw-on mounting on chassis, from top
Terminal	Quick connect terminals 6.3 x 0.8 mm
Operating Temperature	-25 °C to 100 °C
Climatic Category	25/100/21 acc. to IEC 60068-1
Degree of Protection	IP 20 acc. to IEC 60529
Protection Class	Suitable for appliances with protection class I acc. to IEC 61140
MTBF	> 200'000h acc. to MIL-HB-217 F

Approvals and Compliances

Detailed information on product approvals, code requirements, usage instructions and detailed test conditions can be looked up in [Details about Approvals](#)

Approvals

The approval mark is used by the testing authorities to certify compliance with the safety requirements placed on electronic products.
 Approval Reference Type: FMW4-65

Approval Logo	Certificates	Certification Body	Description
	VDE Approvals	VDE	Certificate Number: 40004673

Product standards

Product standards that are referenced

Organization	Design	Standard	Description
	Designed according to	IEC 60939	Passive filters for suppressing electromagnetic interference
	Designed according to	UL 1283	Electromagnetic interference filters





Application standards

Application standards where the product can be used

Organization	Design	Standard	Description
	Designed for applications acc.	IEC/UL 60950	IEC 60950-1 includes the basic requirements for the safety of information technology equipment.

Compliances

The product complies with following Guide Lines

Identification	Details	Initiator	Description
	CE declaration of conformity	SCHURTER AG	The CE marking declares that the product complies with the applicable requirements laid down in the harmonisation of Community legislation on its affixing in accordance with EU Regulation 765/2008.
	RoHS	SCHURTER AG	EU Directive RoHS 2011/65/EU
	China RoHS	SCHURTER AG	The law SJ / T 11363-2006 (China RoHS) has been in force since 1 March 2007. It is similar to the EU directive RoHS.
	REACH	SCHURTER AG	On 1 June 2007, Regulation (EC) No 1907/2006 on the Registration, Evaluation, Authorization and Restriction of Chemicals 1 (abbreviated as "REACH") entered into force.

Dimension [mm]

Case 47

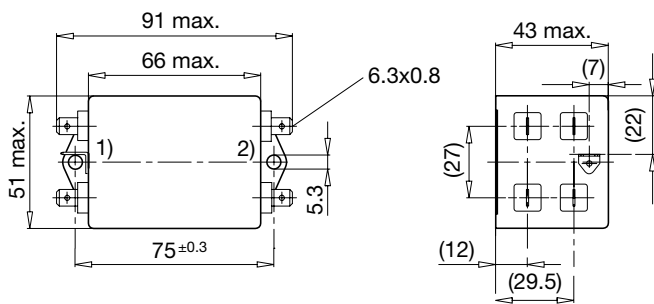

- 1) Line
- 2) Load

Diagrams

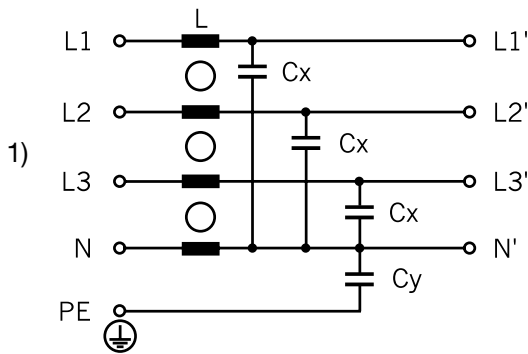

- 1) Line

Attenuation Loss

--- 50Ω differential mode ____ 50Ω common mode

Standard version

3A (FMW-65-0001)

6A (FMW-65-0002)

10A (FMW-65-0003)

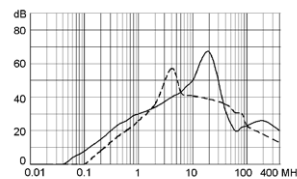
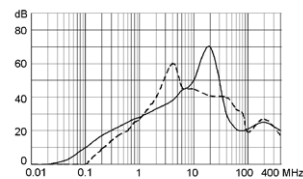
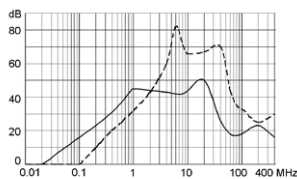

Industrial version

10A (FMW-65-0004)

20A (FMW-65-0005)

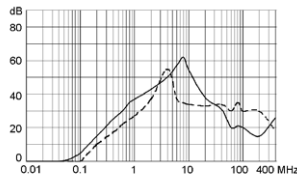
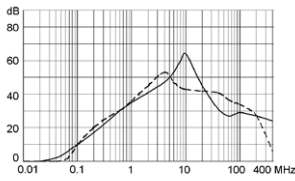

All Variants

Rated Current [A]	Rated Voltage [VAC]	Leakage Current [mA] @ 440V,	L [mH]	Cx [µF]	Cy [nF]	Weight [kg]	Housings	Order Number
3	275/480	0.5	1	0.1	4.7	0.2 kg	47	FMW-65-0001
6	275/480	0.5	0.5	0.1	4.7	0.2 kg	47	FMW-65-0002
10	275/480	0.5	0.4	0.1	4.7	0.23 kg	47	FMW-65-0003
10	275/480	3	0.4	0.1	22	0.35 kg	47	FMW-65-0004
20	275/480	3	0.15	0.1	22	0.25 kg	47	FMW-65-0005

Most Popular.

Availability for all products can be searched real-time: <https://www.schurter.com/en/Stock-Check/Stock-Check-SCHURTER>

1) Nominal leakage current acc. to IEC60950 - 5.2.5. under normal operating conditions. Note: worst case leakage current acc. to IEC60950 - Annex G4 (situation with two interrupted lines) can be much higher.

Packaging unit 10 Pcs