



Chipsmall Limited consists of a professional team with an average of over 10 year of expertise in the distribution of electronic components. Based in Hongkong, we have already established firm and mutual-benefit business relationships with customers from,Europe,America and south Asia,supplying obsolete and hard-to-find components to meet their specific needs.

With the principle of “Quality Parts,Customers Priority,Honest Operation,and Considerate Service”,our business mainly focus on the distribution of electronic components. Line cards we deal with include Microchip,ALPS,ROHM,Xilinx,Pulse,ON,Everlight and Freescale. Main products comprise IC,Modules,Potentiometer,IC Socket,Relay,Connector.Our parts cover such applications as commercial,industrial, and automotives areas.

We are looking forward to setting up business relationship with you and hope to provide you with the best service and solution. Let us make a better world for our industry!



Contact us

Tel: +86-755-8981 8866 Fax: +86-755-8427 6832

Email & Skype: info@chipsmall.com Web: www.chipsmall.com

Address: A1208, Overseas Decoration Building, #122 Zhenhua RD., Futian, Shenzhen, China



STELLA-FRESNEL

~25° street beam for warehouse and outdoor lighting. White version. Compatible with up to 23 mm LES size COBs.

TECHNICAL SPECIFICATIONS:

Dimensions	Ø 90.0 mm
Height	23 mm
Fastening	screw
Colour	white
Box size	480 x 280 x 300 mm
Box weight	6.1 kg
Quantity in Box	135 pcs
ROHS compliant	yes ⓘ







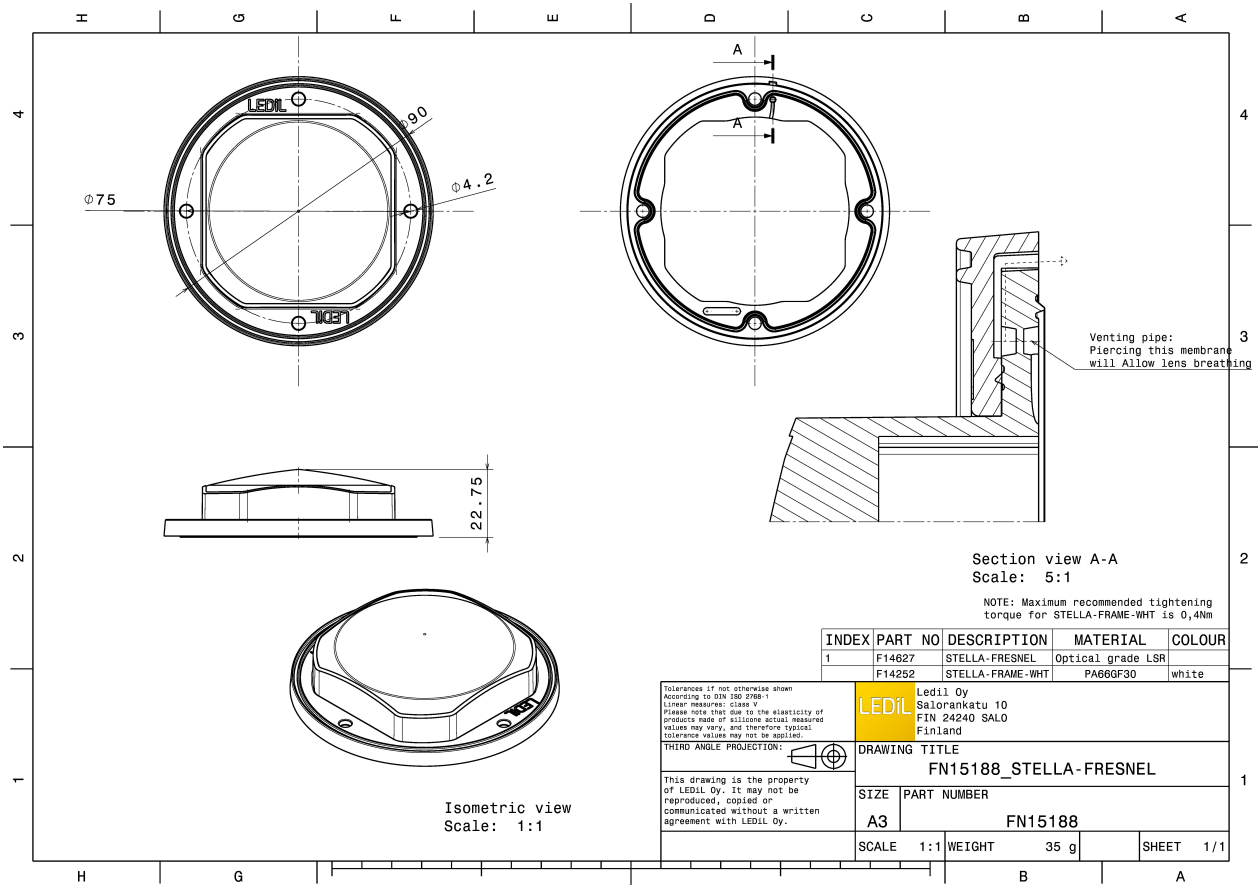

MATERIAL SPECIFICATIONS:

Component	Type	Material	Colour
STELLA-FRESNEL	Lens	Silicone	clear
STELLA-FRAME-WHT	Holder	PA66	white

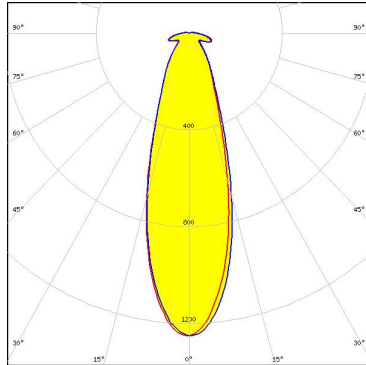
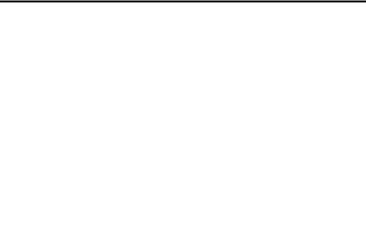
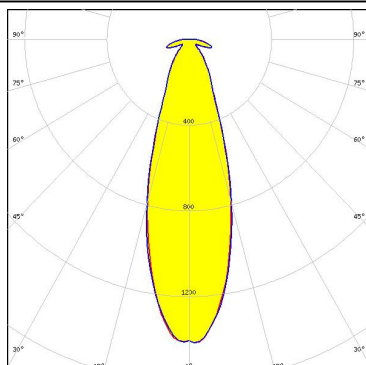

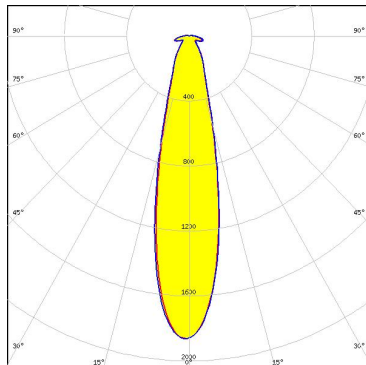
PHOTOMETRIC DATA (MEASURED):

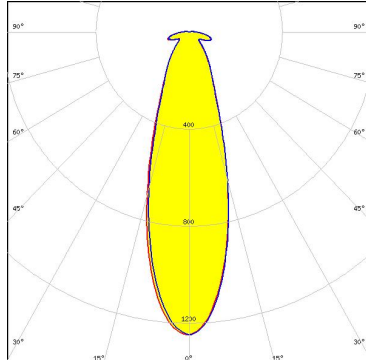
<p> LED Vero SE 18</p> <p>FWHM 32.0°</p> <p>Efficiency 88 %</p> <p>Peak intensity 1.300 cd/lm</p> <p>Required components:</p>		
<p>CITIZEN</p> <p>LED CLL04x/CLU04x</p> <p>FWHM 36.0°</p> <p>Efficiency 86 %</p> <p>Peak intensity 1.100 cd/lm</p> <p>Required components:</p>		
<p> LED CXA/B 1816 & CXA/B 1820 & CXA 1850</p> <p>FWHM 24.0°</p> <p>Efficiency 86 %</p> <p>Peak intensity 1.900 cd/lm</p> <p>Required components:</p>		
<p> LED CXA/B 25xx</p> <p>FWHM 31.0°</p> <p>Efficiency 86 %</p> <p>Peak intensity 1.200 cd/lm</p> <p>Required components:</p>		

PHOTOMETRIC DATA (MEASURED):

LUMILEDS

LED LUXEON CoB 1216/1812
 FWHM 39.0°
 Efficiency 86 %
 Peak intensity 0.930 cd/lm
 Required components:

LUMINUS

LED CXM-22
 FWHM 39.0°
 Efficiency 88 %
 Peak intensity 0.940 cd/lm
 Required components:
 Bender Wirth: 431 Typ L3

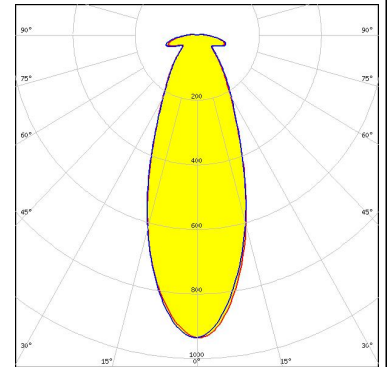
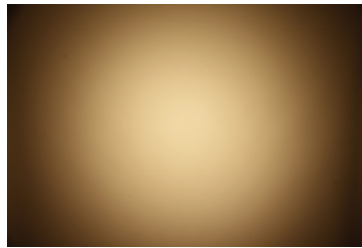

NICHIA

LED COB J-Type
 FWHM 26.0°
 Efficiency 87 %
 Peak intensity 1.600 cd/lm
 Required components:

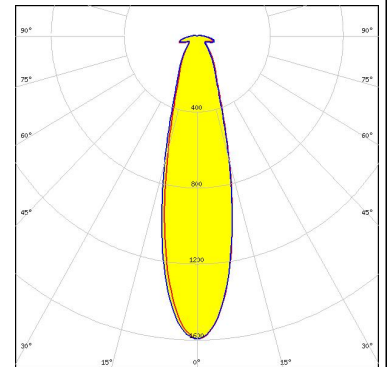
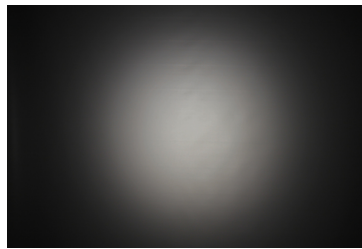

SAMSUNG

LED COB D Series LES 14.5 mm
 FWHM 28.0°
 Efficiency 86 %
 Peak intensity 1.500 cd/lm
 Required components:

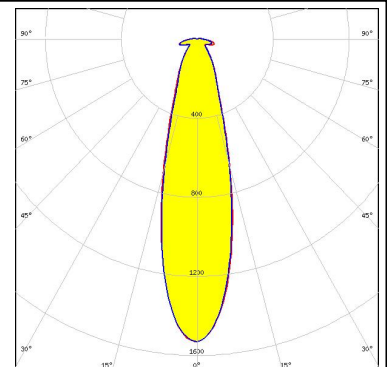
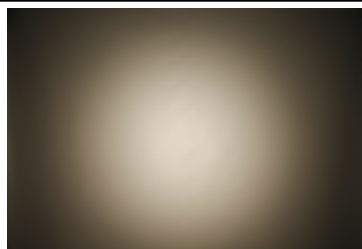

PHOTOMETRIC DATA (MEASURED):

SAMSUNG

LED COB D Series LES 22 mm
 FWHM 38.0°
 Efficiency 86 %
 Peak intensity 0.920 cd/lm
 Required components:

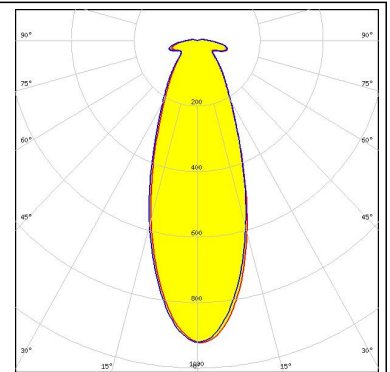
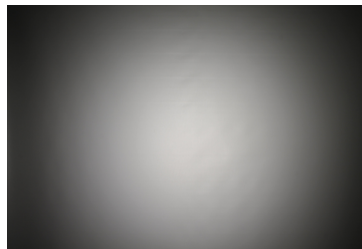

SEOUL SEMICONDUCTOR

LED MJT COB LES 14.5
 FWHM 28.0°
 Efficiency 86 %
 Peak intensity 1.500 cd/lm
 Required components:
 IDEAL: 50-2103CT

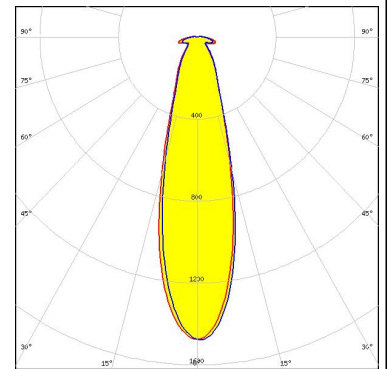
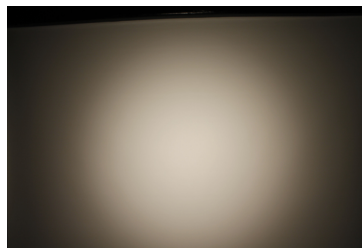

SEOUL SEMICONDUCTOR

LED MJT COB LES 22
 FWHM 36.0°
 Efficiency 87 %
 Peak intensity 0.980 cd/lm
 Required components:
 IDEAL: 50-2204CT

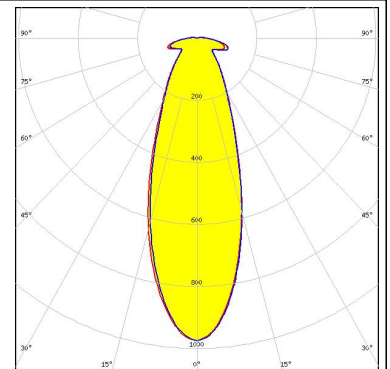

PHOTOMETRIC DATA (SIMULATED):

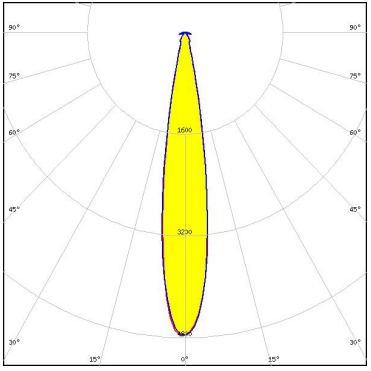
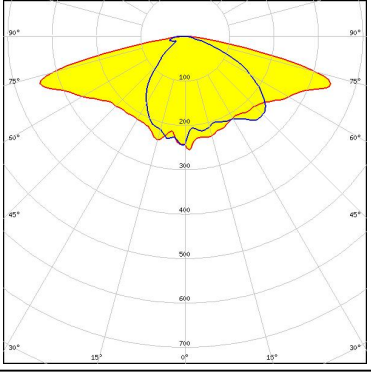
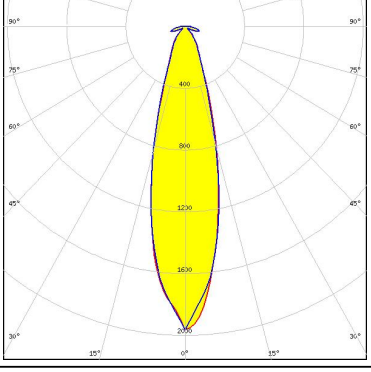
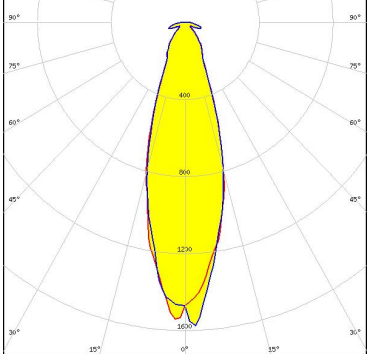
<p>bridgelux.</p> <p>LED V10 Gen7</p> <p>FWHM 17.0°</p> <p>Efficiency 85 %</p> <p>Peak intensity 4.780 cd/lm</p> <p>Required components: Bender Wirth: 434 Typ Z1</p>	
<p>bridgelux.</p> <p>LED V13 Gen7</p> <p>FWHM Asymmetric</p> <p>Efficiency 93 %</p> <p>Peak intensity 0.000 cd/lm</p> <p>Required components:</p>	
<p>bridgelux.</p> <p>LED V18 Gen7</p> <p>FWHM 26.0°</p> <p>Efficiency 85 %</p> <p>Peak intensity 1.970 cd/lm</p> <p>Required components: BJB: 47.319.2350</p>	
<p>bridgelux.</p> <p>LED V22 Gen7</p> <p>FWHM 30.0°</p> <p>Efficiency 84 %</p> <p>Peak intensity 1.583 cd/lm</p> <p>Required components: IDEAL: 50-2204CT</p>	

PHOTOMETRIC DATA (SIMULATED):



LED CXA/B 25xx
FWHM 24.0°
Efficiency 86 %
Peak intensity 2.600 cd/lm
Required components:

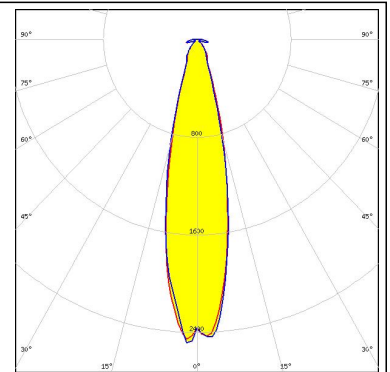

LED LUXEON CoB 1208
FWHM 22.0°
Efficiency 85 %
Peak intensity 2.800 cd/lm
Required components:

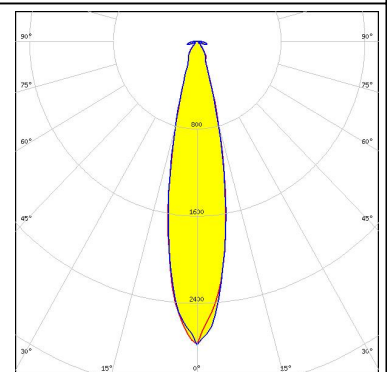

GENERAL INFORMATION:

NOTE: The typical beam angle will be changed by different color, chip size and chip position tolerance. The typical total beam angle is the full angle measured where the luminous intensity is half of the peak value.

Due to use of high power COB's with this product, special attention to proper thermal design is highly recommended. LEDiL has no liability for direct, indirect or consecutive damages arising from the LEDiL products being used outside of the recommended temperature range.

MATERIALS:

As part of our continuous research and improvement processes, and to ensure the best possible quality and availability of our products, LEDiL reserves the right to change material grades without notice.

PRODUCT DATA USER AGREEMENT AND DISCLAIMER:

The measured data in the provided downloadable LEDiL Product Datasheets and Mechanical 2D-Drawings is rounded and provided as reference for planning. LEDiL Oy's optical specifications have been verified by conducting performance testing of the products in accordance with the company's quality system. The reported data are averaged results of multiple measurements with typical variation. LEDiL Oy reserves the right to without prior notification make changes and improvements to its products.

LEDiL Oy assumes neither warranty, nor guarantee nor any other liability of any kind for the contents and correctness of the provided data. The provided data has been generated with highest diligence but the provided data may in reality not represent the complete possible variation range of all intrinsic parameters. Therefore, in certain cases a deviation from the provided data could occur.

LEDiL Oy reserves the right to undertake technical changes of its products without further notification which could lead to changes in the provided data. LEDiL Oy assumes no liability of any kind for the possible deviation from any provided data or any other damage resulting from the usage of the provided data.

The user agrees to this disclaimer and user agreement with the download or usage of the provided files.

LEDiL Oy

Joensuunkatu 13
FI-24240 SALO
Finland

LEDiL Inc.

228 West Page Street
Suite D
Sycamore IL 60178
USA

Local sales and technical support

www.ledil.com/where_to_buy

Shipping locations

Salo, Finland
Hong Kong, China

Distribution Partners

www.ledil.com/where_to_buy