



Chipsmall Limited consists of a professional team with an average of over 10 year of expertise in the distribution of electronic components. Based in Hongkong, we have already established firm and mutual-benefit business relationships with customers from,Europe,America and south Asia,supplying obsolete and hard-to-find components to meet their specific needs.

With the principle of “Quality Parts,Customers Priority,Honest Operation,and Considerate Service”,our business mainly focus on the distribution of electronic components. Line cards we deal with include Microchip,ALPS,ROHM,Xilinx,Pulse,ON,Everlight and Freescale. Main products comprise IC,Modules,Potentiometer,IC Socket,Relay,Connector.Our parts cover such applications as commercial,industrial, and automotives areas.

We are looking forward to setting up business relationship with you and hope to provide you with the best service and solution. Let us make a better world for our industry!



Contact us

Tel: +86-755-8981 8866 Fax: +86-755-8427 6832

Email & Skype: info@chipsmall.com Web: www.chipsmall.com

Address: A1208, Overseas Decoration Building, #122 Zhenhua RD., Futian, Shenzhen, China



RONDA-WWW

~90° very wide beam with holder A compatible with 3rd party connectors from TE, Bender+Wirth and IDEAL

TECHNICAL SPECIFICATIONS:

Dimensions	Ø 69.9 mm
Height	14.6 mm
Fastening	socket
Colour	white
Box size	
Box weight	0 kg
Quantity in Box	420 pcs
ROHS compliant	yes ⓘ

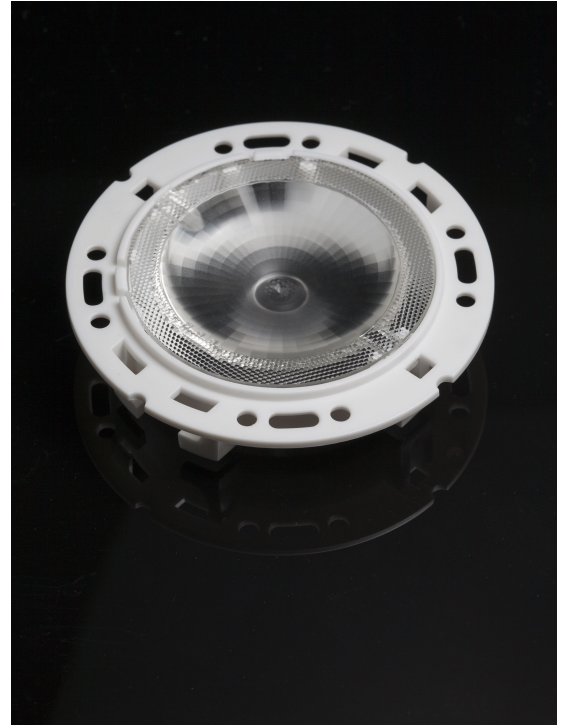

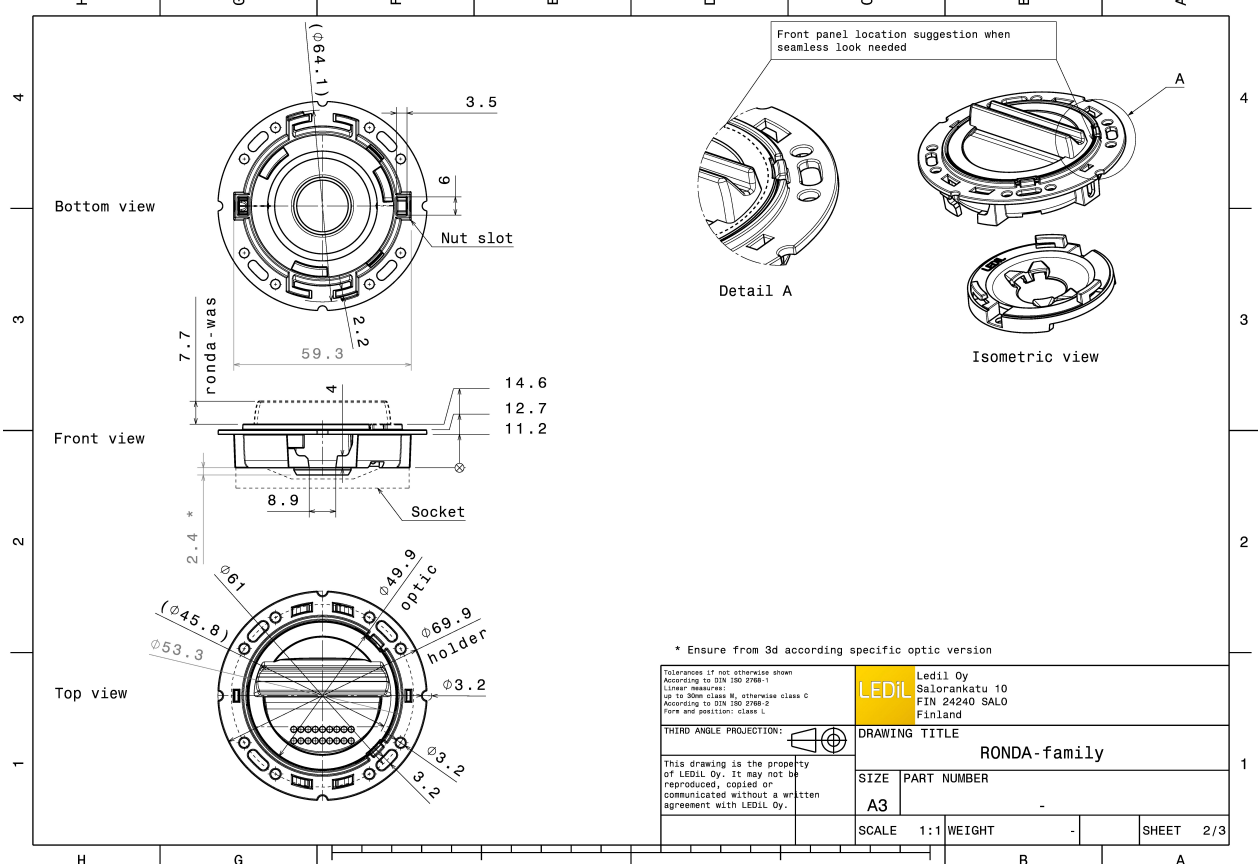
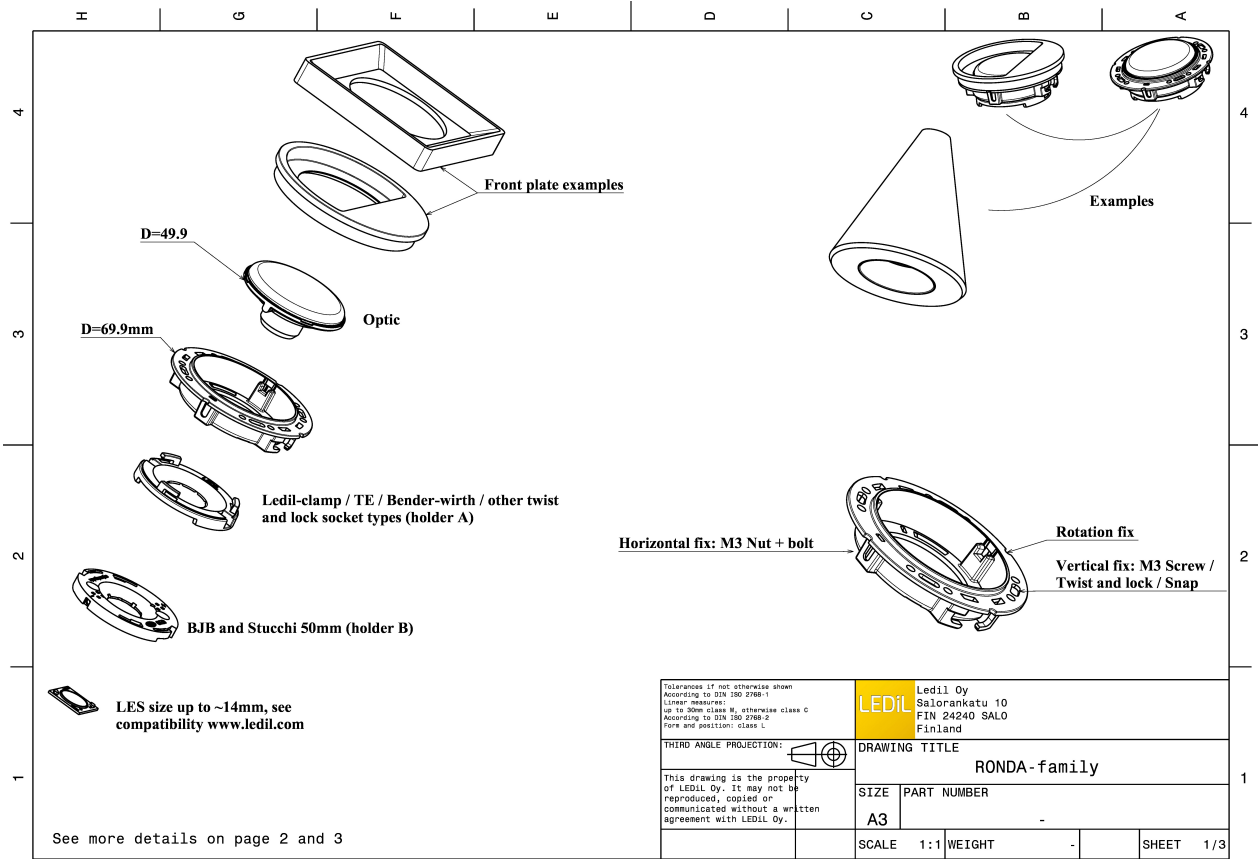

MATERIAL SPECIFICATIONS:

Component	Type	Material	Colour
RONDA-WWW	Lens	PMMA	clear
RONDA-HLD-A	Holder	PC	white

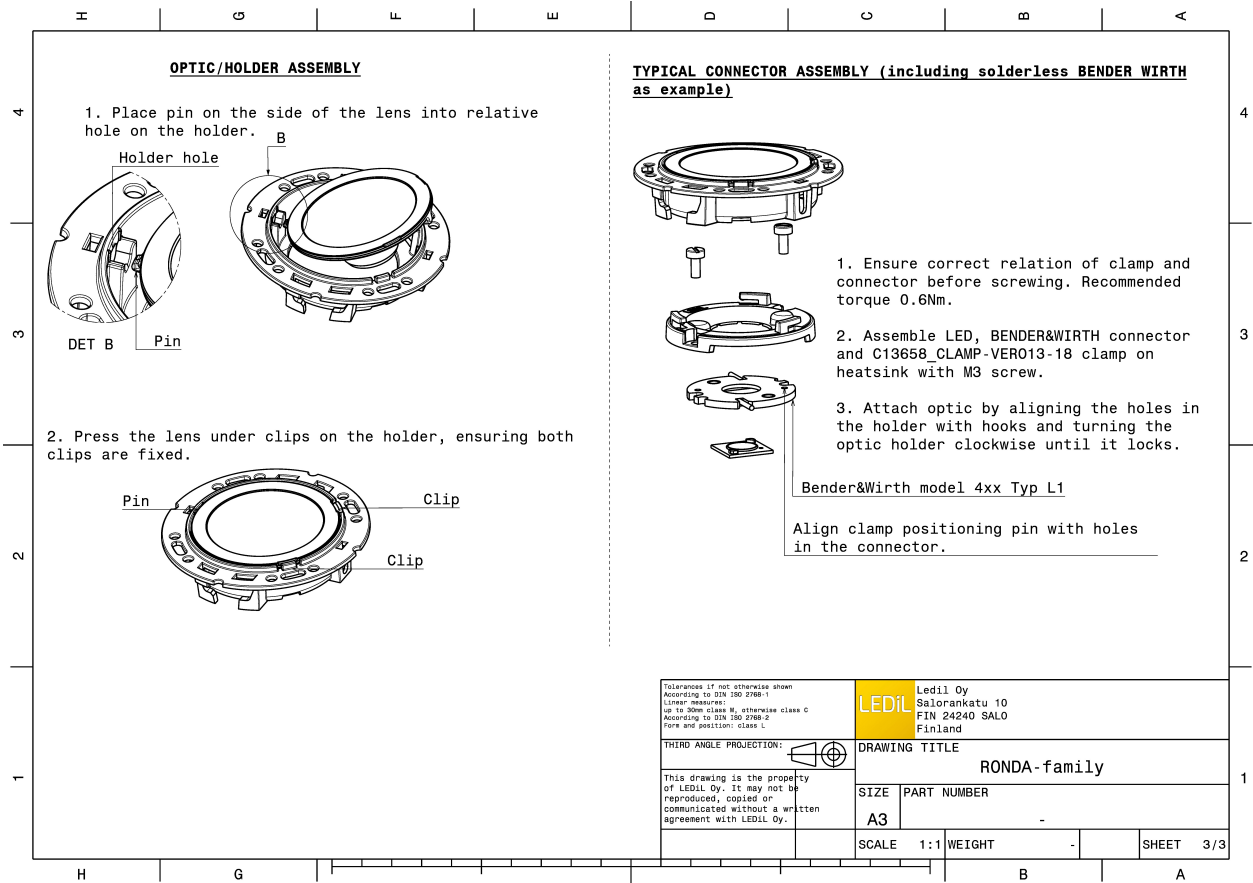

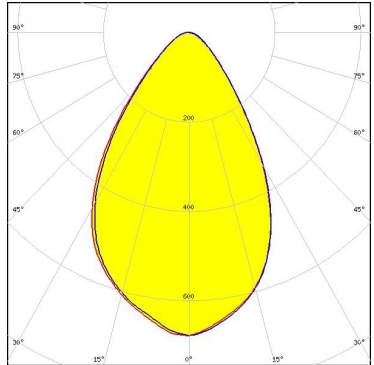
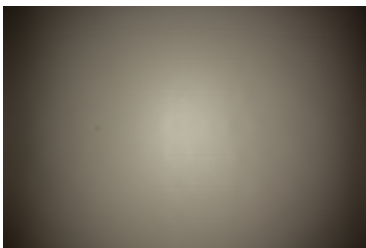
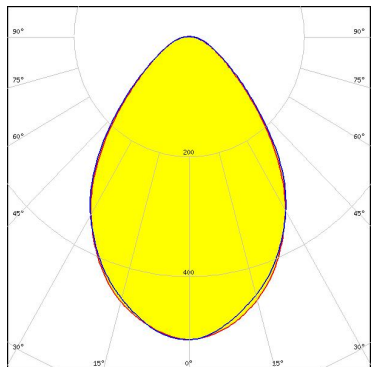

PHOTOMETRIC DATA (MEASURED):

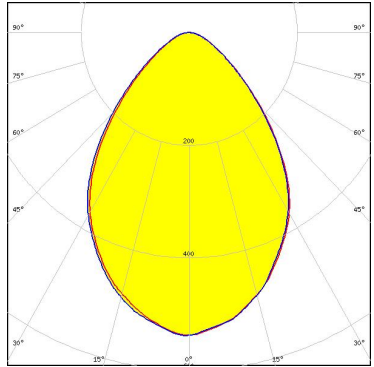
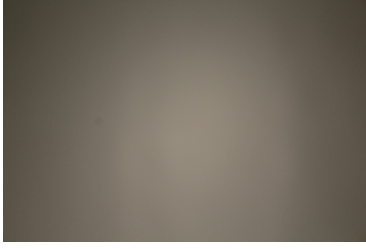
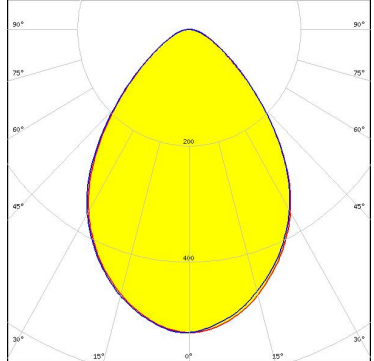
<p>bridgelux.</p> <p>LED V10 Gen7</p> <p>FWHM 66.0°</p> <p>Efficiency 87 %</p> <p>Peak intensity 0.680 cd/lm</p> <p>Required components: C13658_CLAMP-VERO13-18 Bender Wirth: 434 Typ L1</p>		
<p>bridgelux.</p> <p>LED V13 Gen7</p> <p>FWHM 76.0°</p> <p>Efficiency 82 %</p> <p>Peak intensity 0.510 cd/lm</p> <p>Required components: TE: 2213254-2 + OPTIC CLIP Z50 TYPE1 2213194-1</p>		
<p>bridgelux.</p> <p>LED Vero SE 13</p> <p>FWHM 78.0°</p> <p>Efficiency 88 %</p> <p>Peak intensity 0.540 cd/lm</p> <p>Required components: C16402_CLAMP-VEROSE-13-18</p>		
<p>bridgelux.</p> <p>LED VERO13</p> <p>FWHM 78.0°</p> <p>Efficiency 87 %</p> <p>Peak intensity 0.520 cd/lm</p> <p>Required components: C13658_CLAMP-VERO13-18</p>		

PHOTOMETRIC DATA (MEASURED):



LED CMA1840
 FWHM 78.0°
 Efficiency 86 %
 Peak intensity 0.510 cd/lm
 Required components:
 C14123_CLAMP-CXA15-18

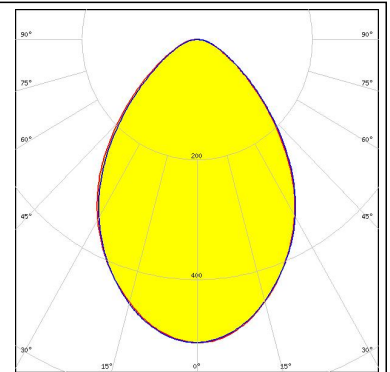

LED CXA/B 1816 & CXA/B 1820 & CXA 1850
 FWHM 80.0°
 Efficiency 90 %
 Peak intensity 0.500 cd/lm
 Required components:
 LEDiL: C14123_CLAMP-CXA15-18

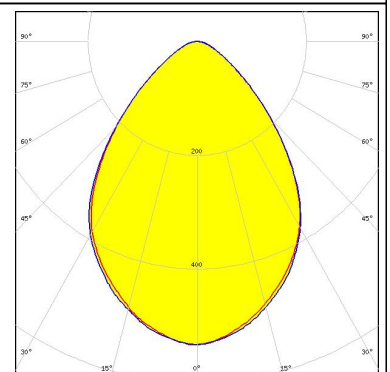
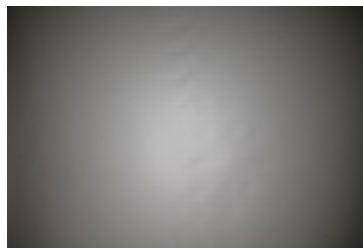

LED COB J-Type
 FWHM 74.0°
 Efficiency 82 %
 Peak intensity 0.490 cd/lm
 Required components:
 IDEAL: 50-2103NC + 50-2100AN

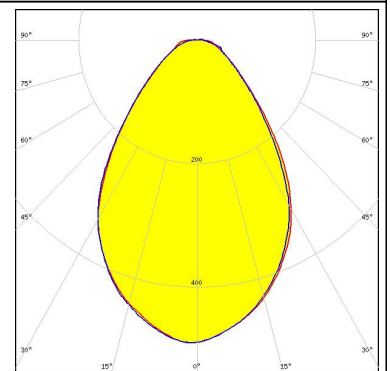
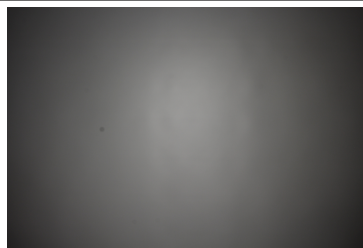

LED Fortimo SLM L13 Standard
 FWHM 73.0°
 Efficiency 82 %
 Peak intensity 0.530 cd/lm
 Required components:
 TE: OPTIC CLIP Z50 TYPE1 2213194-1

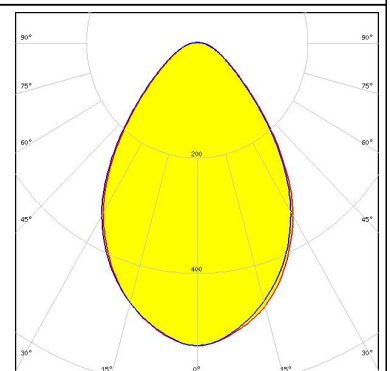
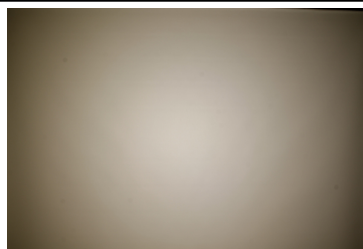

PHOTOMETRIC DATA (MEASURED):

PHILIPS

LED Fortimo SLM L15 Standard
FWHM 78.0°
Efficiency 80 %
Peak intensity 0.460 cd/lm
Required components:
TE: OPTIC CLIP Z50 TYPE1 2213194-1

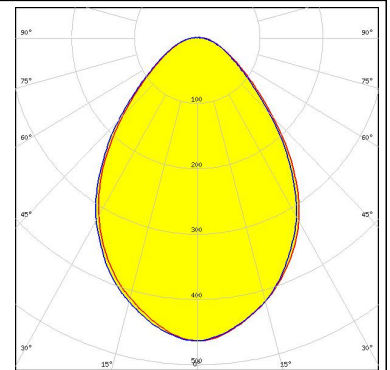

SAMSUNG

LED LC040C
FWHM 74.0°
Efficiency 85 %
Peak intensity 0.550 cd/lm
Required components:
TE: 2213382-2 + OPTIC CLIP Z50 TYPE1 2213194-1

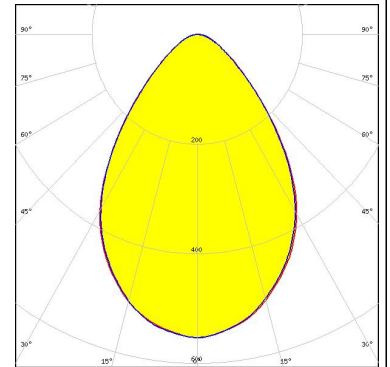

SEOUL SEMICONDUCTOR

LED AC Zhaga COB
FWHM 78.0°
Efficiency 83 %
Peak intensity 0.490 cd/lm
Required components:
Optosource: SEHSMJD-A

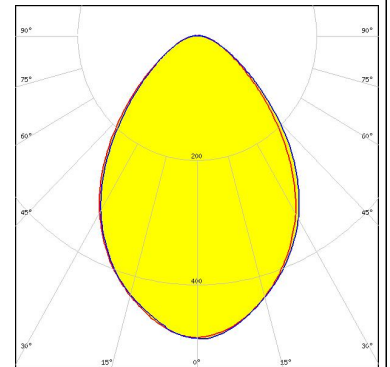

SEOUL SEMICONDUCTOR

LED MJT COB LES 14.5
FWHM 79.0°
Efficiency 80 %
Peak intensity 0.500 cd/lm
Required components:
TE: 2213254-2 + OPTIC CLIP Z50 TYPE1 2213194-1

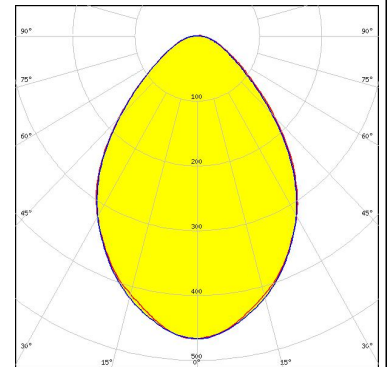
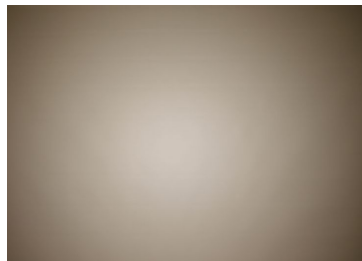

PHOTOMETRIC DATA (SIMULATED):

bridgelux.

LED V10 Gen6
FWHM 89.0°
Efficiency 86 %
Peak intensity 0.450 cd/lm
Required components:
C14123_CLAMP-CXA15-18

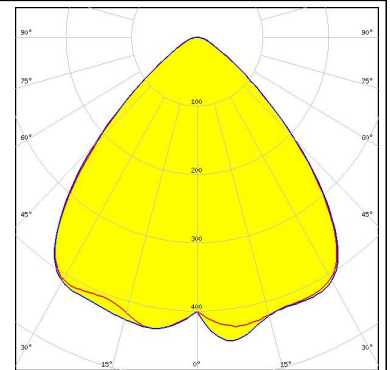

bridgelux.

LED V13 Gen7
FWHM 80.0°
Efficiency 82 %
Peak intensity 0.510 cd/lm
Required components:
C13658_CLAMP-VERO13-18
Bender Wirth: 477 Typ L1

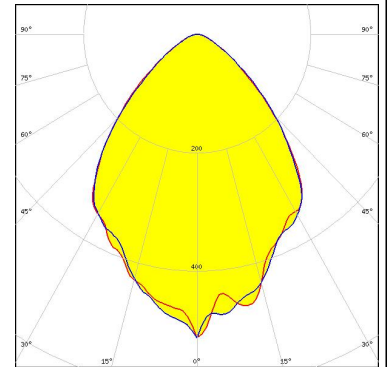

bridgelux.

LED V13 Gen7
FWHM 72.0°
Efficiency 86 %
Peak intensity 0.580 cd/lm
Required components:
IDEAL: 50-2103CT + 50-2100AN

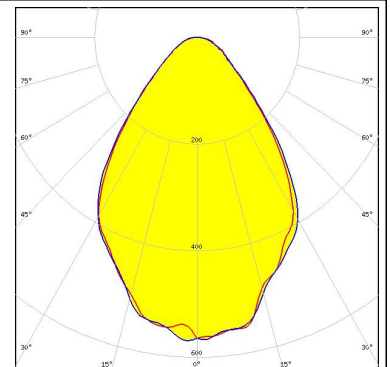

CITIZEN

LED CLL02x/CLU02x (LES10)
FWHM 90.0°
Efficiency 86 %
Peak intensity 0.430 cd/lm
Required components:
C13658_CLAMP-VERO13-18
Bender Wirth: 434 Typ L1

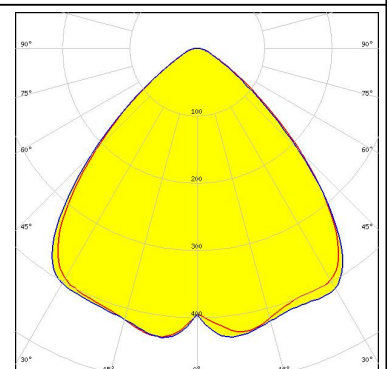

PHOTOMETRIC DATA (SIMULATED):

CITIZEN

LED CLU700/701
FWHM 90.0°
Efficiency 87 %
Peak intensity 0.490 cd/lm
Required components:
C13658_CLAMP-VERO13-18
Bender Wirth: 434 Typ L1

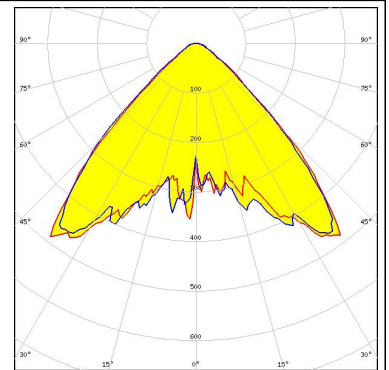

CITIZEN

LED CLU710/711
FWHM 88.0°
Efficiency 87 %
Peak intensity 0.470 cd/lm
Required components:
C13658_CLAMP-VERO13-18
Bender Wirth: 470 Typ L1

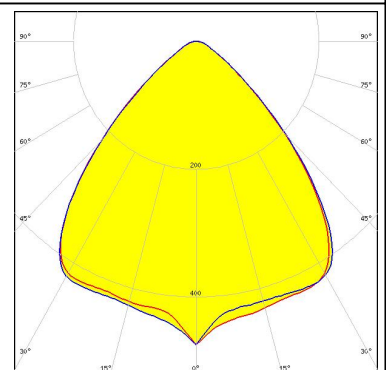

CREE

LED CXA/B 13xx
FWHM 90.0°
Efficiency 87 %
Peak intensity 0.460 cd/lm
Required components:
C13658_CLAMP-VERO13-18
Bender Wirth: 448 Typ L1

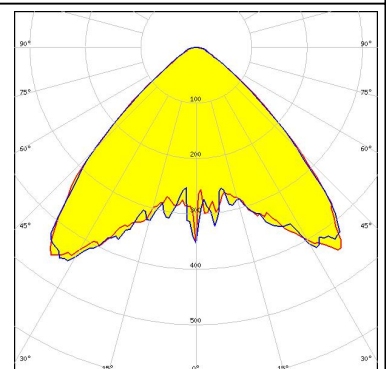

CREE

LED CXA/B 15xx
FWHM 90.0°
Efficiency 87 %
Peak intensity 0.410 cd/lm
Required components:
C14123_CLAMP-CXA15-18

PHOTOMETRIC DATA (SIMULATED):

CREE

LED CXA/B 15xx
FWHM 90.0°
Efficiency 87 %
Peak intensity 0.410 cd/lm
Required components:
C13658_CLAMP-VERO13-18
Bender Wirth: 441 Typ L1

CREE

LED CXA/B 1816 & CXA/B 1820 & CXA 1850
FWHM 90.0°
Efficiency 87 %
Peak intensity 0.430 cd/lm
Required components:
C13658_CLAMP-VERO13-18
Bender Wirth: 437 Typ L1

CREE

LED CXA/B 1816 & CXA/B 1820 & CXA 1850
FWHM 84.0°
Efficiency 84 %
Peak intensity cd/lm
Required components:
TE: 2213401-2 + OPTIC CLIP Z50 TYPE1 2213194-1

CREE

LED CXA/B 1816 & CXA/B 1820 & CXA 1850
FWHM 90.0°
Efficiency 87 %
Peak intensity 0.430 cd/lm
Required components:
C14123_CLAMP-CXA15-18

PHOTOMETRIC DATA (SIMULATED):



LED CXA/B 1830
FWHM 84.0°
Efficiency 85 %
Peak intensity cd/lm
Required components:
C14123_CLAMP-CXA15-18



LED LUXEON CoB 1202/1203
FWHM 82.0°
Efficiency 86 %
Peak intensity 0.510 cd/lm
Required components:
TE: 2213382-2 + OPTIC CLIP Z50 TYPE1 2213194-1

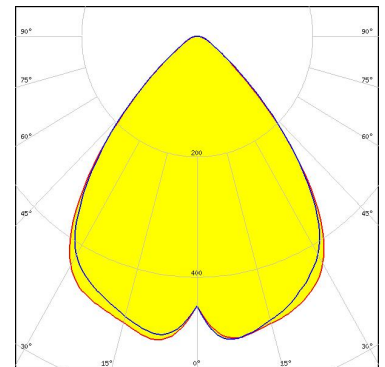

LED LUXEON CoB 1202s
FWHM 90.0°
Efficiency 87 %
Peak intensity 0.420 cd/lm
Required components:
C13658_CLAMP-VERO13-18
Bender Wirth: 452 Typ L1

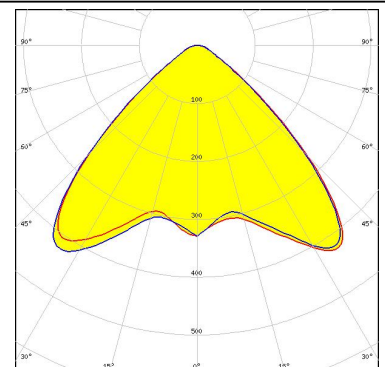

LED COB L-Type (LES 9)
FWHM 83.0°
Efficiency 86 %
Peak intensity 0.500 cd/lm
Required components:
TE: 2213382-2 + OPTIC CLIP Z50 TYPE1 2213194-1

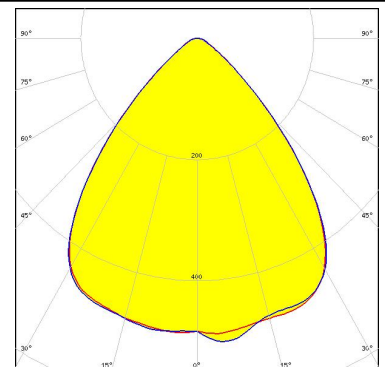

PHOTOMETRIC DATA (SIMULATED):



LED NSCxL036A
FWHM 85.0°
Efficiency 87 %
Peak intensity 0.490 cd/lm

Required components:

TE: 2213382-2 + OPTIC CLIP Z50 TYPE1 2213194-1



LED Duris S10
FWHM 99.0°
Efficiency 86 %
Peak intensity 0.360 cd/lm

Required components:

C13658_CLAMP-VERO13-18



LED Mini Zenigata (GW6BM)
FWHM 88.0°
Efficiency 86 %
Peak intensity 0.470 cd/lm

Required components:

C13658_CLAMP-VERO13-18

Bender Wirth: 452 Typ L1

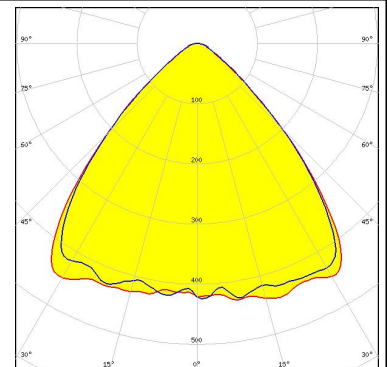

LED SLE G6 LES15
FWHM 76.0°
Efficiency 80 %
Peak intensity 0.520 cd/lm

Required components:

TE: 2213254-2 + OPTIC CLIP Z50 TYPE1 2213194-1

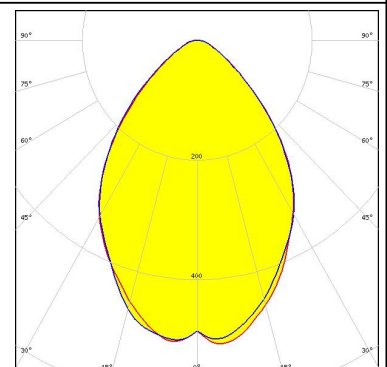

GENERAL INFORMATION:

NOTE: The typical beam angle will be changed by different color, chip size and chip position tolerance. The typical total beam angle is the full angle measured where the luminous intensity is half of the peak value.

Due to use of high power COB's with this product, special attention to proper thermal design is highly recommended. LEDiL has no liability for direct, indirect or consecutive damages arising from the LEDiL products being used outside of the recommended temperature range.

MATERIALS:

As part of our continuous research and improvement processes, and to ensure the best possible quality and availability of our products, LEDiL reserves the right to change material grades without notice.

PRODUCT DATA USER AGREEMENT AND DISCLAIMER:

The measured data in the provided downloadable LEDiL Product Datasheets and Mechanical 2D-Drawings is rounded and provided as reference for planning. LEDiL Oy's optical specifications have been verified by conducting performance testing of the products in accordance with the company's quality system. The reported data are averaged results of multiple measurements with typical variation. LEDiL Oy reserves the right to without prior notification make changes and improvements to its products.

LEDiL Oy assumes neither warranty, nor guarantee nor any other liability of any kind for the contents and correctness of the provided data. The provided data has been generated with highest diligence but the provided data may in reality not represent the complete possible variation range of all intrinsic parameters. Therefore, in certain cases a deviation from the provided data could occur.

LEDiL Oy reserves the right to undertake technical changes of its products without further notification which could lead to changes in the provided data. LEDiL Oy assumes no liability of any kind for the possible deviation from any provided data or any other damage resulting from the usage of the provided data.

The user agrees to this disclaimer and user agreement with the download or usage of the provided files.

LEDiL Oy

Joensuunkatu 13
FI-24240 SALO
Finland

LEDiL Inc.

228 West Page Street
Suite D
Sycamore IL 60178
USA

Local sales and technical support

[www.ledil.com/
where_to_buy](http://www.ledil.com/where_to_buy)

Shipping locations

Salo, Finland
Hong Kong, China

Distribution Partners

[www.ledil.com/
where_to_buy](http://www.ledil.com/where_to_buy)