



Chipsmall Limited consists of a professional team with an average of over 10 year of expertise in the distribution of electronic components. Based in Hongkong, we have already established firm and mutual-benefit business relationships with customers from,Europe,America and south Asia,supplying obsolete and hard-to-find components to meet their specific needs.

With the principle of “Quality Parts,Customers Priority,Honest Operation,and Considerate Service”,our business mainly focus on the distribution of electronic components. Line cards we deal with include Microchip,ALPS,ROHM,Xilinx,Pulse,ON,Everlight and Freescale. Main products comprise IC,Modules,Potentiometer,IC Socket,Relay,Connector.Our parts cover such applications as commercial,industrial, and automotives areas.

We are looking forward to setting up business relationship with you and hope to provide you with the best service and solution. Let us make a better world for our industry!



## Contact us

Tel: +86-755-8981 8866 Fax: +86-755-8427 6832

Email & Skype: info@chipsmall.com Web: www.chipsmall.com

Address: A1208, Overseas Decoration Building, #122 Zhenhua RD., Futian, Shenzhen, China



# Multi-stage High Performance AC/DC EMI Filter



- Rated currents from 1 to 16 A
- High differential and common-mode attenuation
- Good low frequency attenuation
- Optional medical versions (B type)
- Optional safety versions (A type)



### Performance indicators

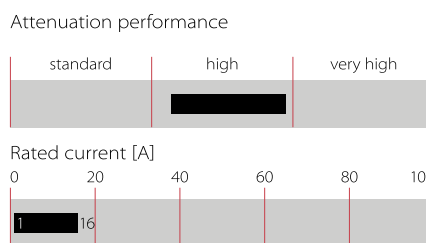

## Technical specifications

<b>Rated voltage*</b>	250 VAC, 50/60 Hz; 250 VDC
<b>Operating frequency</b>	DC to 400 Hz
<b>Rated currents</b>	1 to 16 A @ 40°C max.
<b>High potential test voltage</b>	P → PE 2000 VAC for 2 sec P → PE 2500 VAC for 2 sec (B types) P → N 1100 VDC for 2 sec
<b>Temperature range (operation and storage)</b>	-25°C to +100°C (25/100/21)
<b>Certified to</b>	UL 1283, CSA 22.2 No. 8 1986, IEC/EN 60939 (applies to AC and DC applications)
<b>Flammability corresponding to</b>	UL 94 V-2 or better
<b>Design corresponding to</b>	UL 1283, CSA 22.2 No. 8 1986, IEC/EN 60939
<b>MTBF @ 40°C/230 V (Mil-HB-217F)</b>	1,650,000 hours 1,700,000 hours (B types)

\*maximum RMS operating voltage at rated frequency or the maximum DC operating voltage

### Approvals



### Features and benefits

- FN 2080 two-stage filters are designed for easy and fast chassis mounting
- FN 2080 filters are also available as B versions without Y-capacitors for medical applications as well as A version with low capacitance for safety critical applications with necessity for low leakage currents
- All filters provide a high conducted attenuation performance, based on chokes with high saturation resistance and excellent thermal behavior
- FN 2080 two-stage filters are designed with good low frequency attenuation
- FN 2080 filters are also available as single-stage filters
- FN 2080 filters are also available with two common mode choke configuration (FN 2070 series)
- Various terminal options allow you to select the desired connection style



### Typical applications

- Electrical and electronic equipment
- Consumer goods
- Household equipment
- Building automation
- Industrial applications
- Machinery
- Medical equipment
- Electronic data processing equipment
- Office automation and datacom equipment
- Various noisy applications requiring good filter performance

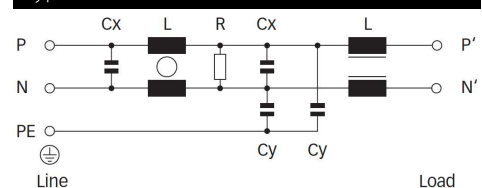
### Typical electrical schematic



### Filter selection table

Filter*	Rated current @ 40°C (25°C)	Leakage current** @ 250 VAC/50 Hz (@ 120 VAC/60 Hz)	Inductance		Capacitance		Resistance R	Input/Output connections			Weight [g]
			L	L1	Cx	Cy					
	[A]	[mA]	[mH]	[µH]	[µF]	[nF]	[kΩ]				
FN 2080-1-..	1 (1.2)	0.66 (0.38)	22	490	0.33	4.7	1000	-06	-07		200
FN 2080-3-..	3 (3.5)	0.66 (0.38)	9.8	160	0.47	4.7	470	-06	-07		270
FN 2080-6-..	6 (6.9)	0.66 (0.38)	7.8	110	1	4.7	220	-06	-07		470
FN 2080-10-..	10 (11.5)	0.66 (0.38)	4.5	60	1	4.7	220	-06	-07		750
FN 2080-12-..	12 (13.8)	0.66 (0.38)	3.25	50	1	4.7	220	-06	-07		750
FN 2080-16-..	16 (18.4)	0.66 (0.38)	2.8	43	1	4.7	220	-06	-07	-08	1020
FN 2080A-1-..	1 (1.2)	0.07 (0.04)	22	490	0.33	0.47	1000	-06	-07		200
FN 2080A-3-..	3 (3.5)	0.07 (0.04)	9.8	160	0.47	0.47	470	-06	-07		270
FN 2080A-6-..	6 (6.9)	0.07 (0.04)	7.8	110	1	0.47	220	-06	-07		470
FN 2080A-10-..	10 (11.5)	0.07 (0.04)	4.5	60	1	0.47	220	-06	-07		750
FN 2080A-12-..	12 (13.8)	0.07 (0.04)	3.25	50	1	0.47	220	-06	-07		750
FN 2080A-16-..	16 (18.4)	0.07 (0.04)	2.8	43	1	0.47	220	-06	-07	-08	1020
FN 2080B-1-..	1 (1.2)	0.00	22	490	0.33		1000	-06	-07		200
FN 2080B-3-..	3 (3.5)	0.00	9.8	160	0.47		470	-06	-07		270
FN 2080B-6-..	6 (6.9)	0.00	7.8	110	1		220	-06	-07		470
FN 2080B-10-..	10 (11.5)	0.00	4.5	60	1		220	-06	-07		750
FN 2080B-12-..	12 (13.8)	0.00	3.25	50	1		220	-06	-07		750
FN 2080B-16-..	16 (18.4)	0.00	2.8	43	1		220	-06	-07	-08	1020

\* To compile a complete part number, please replace the .. with the required I/O connection style (e.g. FN 2080-16-08, FN 2080B-10-06).

\*\* Maximum leakage under usual AC operating conditions (acc. IEC 60939-3). Note: if the neutral line is interrupted, worst case leakage could reach twice this level. Leakage current for DC application is 0 mA;

### Typical filter attenuation

Per CISPR 17; A=50 Ω/50 Ω sym; B=50 Ω/50 Ω asym; C=0.1 Ω/100 Ω sym; D=100 Ω/0.1 Ω sym

1 to 6 A types

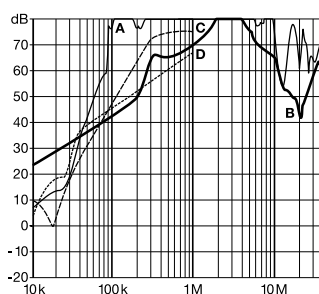

10 and 12 A types

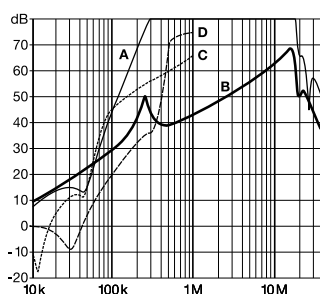

16 A types

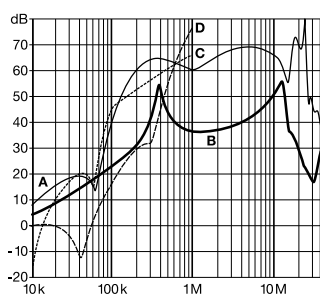

**Mechanical data**

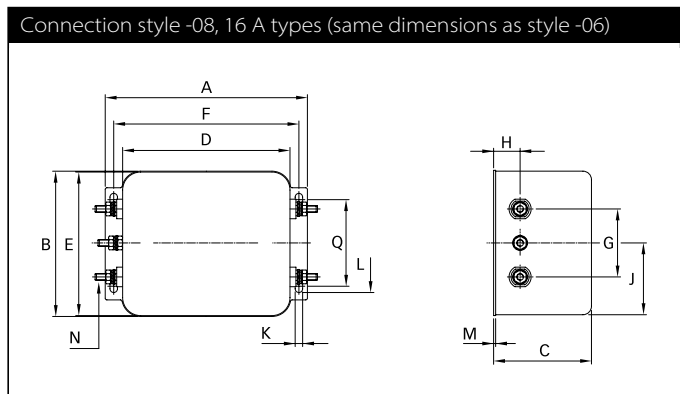
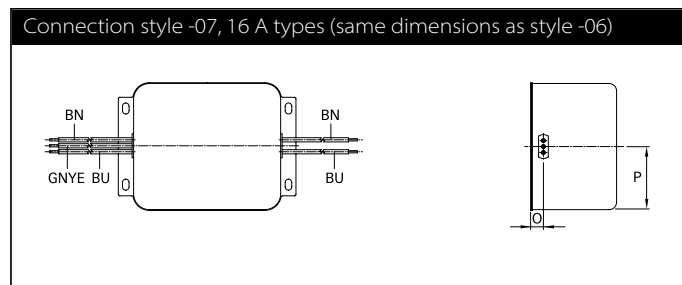
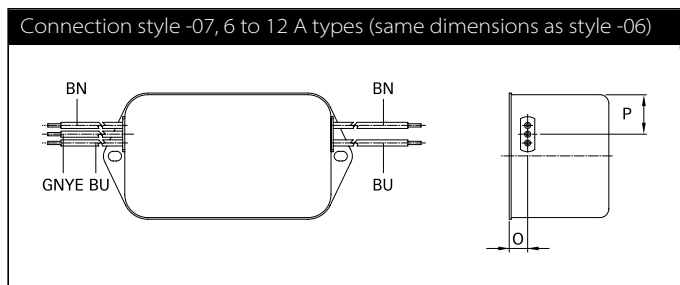
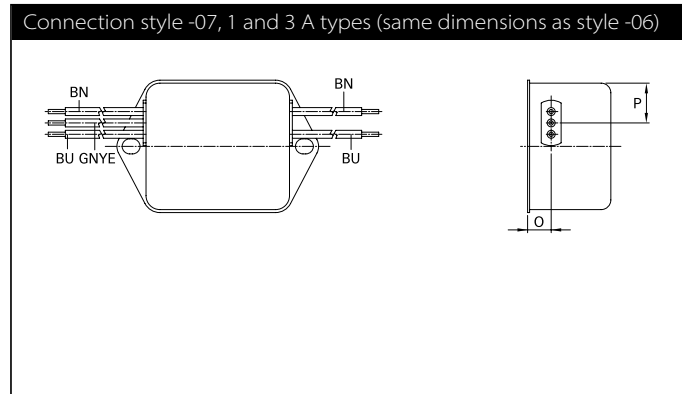
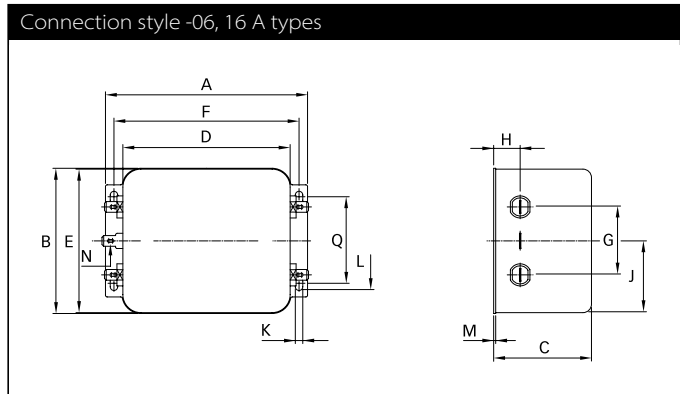
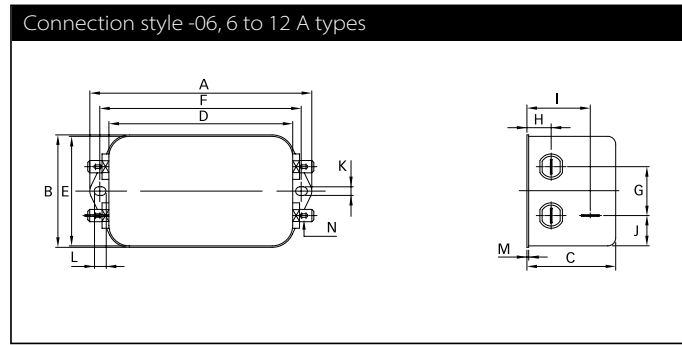
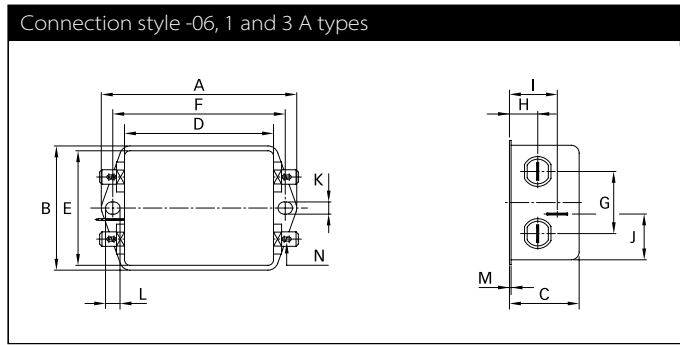

## Dimensions

	1 A	3 A	6 A	10 A	12 A	16 A	Tolerances
<b>A</b>	85	85	113.5 ±1	156 ±1	156 ±1	119 ±1	±0.5
<b>B</b>	54	54	57.5 ±1	57.5 ±1	57.5 ±1	85.5 ±1	±0.5
<b>C</b>	30.3	40.3	45.4 ±1	45.4 ±1	45.4 ±1	57.6 ±1	±0.5
<b>D</b>	64.8	64.8	94 ±1	130.5 ±1	130.5 ±1	98.5 ±1	±0.5
<b>E</b>	49.8	49.8	56	56	56	84.5	±0.5
<b>F</b>	75	75	103	143	143	109	±0.3
<b>G</b>	27	27	25	25	25	40	±0.2
<b>H</b>	12.3	12.3	12.4	12.4	12.4	15.6	±0.5
<b>I</b>	20.8	29.8	32.4	32.5	32.5		±0.5
<b>J</b>	19.9	11.4	15.5	15.5	15.5	42.25	±0.5
<b>K</b>	5.3	5.3	4.4	5.3	5.3	4.4	
<b>L</b>	6.3	6.3	6	6	6	7.4	
<b>M</b>	0.7	0.7	0.9	1	1	1.2	
<b>Connection style -06</b>							
<b>N</b>	6.3 x 0.8	6.3 x 0.8	6.3 x 0.8	6.3 x 0.8	6.3 x 0.8	6.3 x 0.8	
<b>Connection style -07</b>							
<b>O</b>	8.3	8.3	8.4	8.4	8.4	8.6	±0.5
<b>P</b>	14.9	14.9	18	18	18	42.25	±0.5
<b>AWG type wire</b>	AWG 20	AWG 20	AWG 18	AWG 18	AWG 16	AWG 16	
<b>Wire length</b>	140	140	140	140	140	140	+5
<b>Connection style -08</b>							
<b>N</b>						M4	
<b>Q</b>						51	±0.2
<b>Recommended torque (Nm)</b>						1.2 - 1.3	

All dimensions in mm; 1 inch = 25.4 mm  
Tolerances according: ISO 2768-m/EN 22768-m

Please visit [www.schaffner.com](http://www.schaffner.com) to find more details on filter connectors.



## Headquarters, global innovation and development

### Switzerland

#### Schaffner Group

Nordstrasse 11  
4542 Luterbach  
T +41 32 681 66 26  
[info@schaffner.com](mailto:info@schaffner.com)  
<http://www.schaffner.com>



## Sales and application centers

### China

#### Schaffner EMC Ltd. Shanghai

T20-3 C, No 565 Chuangye Road,  
Pudong district  
201201 Shanghai  
T +86 21 3813 9500  
[cschina@schaffner.com](mailto:cschina@schaffner.com)  
<http://www.schaffner.com.cn>

### Finland

#### Schaffner Oy

Sauvonrinne 19 H  
08500 Lohja  
T +358 50 468 7284  
[finlandsales@schaffner.com](mailto:finlandsales@schaffner.com)

### France

#### Schaffner EMC S.A.S.

16-20 Rue Louis Rameau  
95875 Bezons  
T +33 1 34 34 30 60  
F +33 1 39 47 02 28  
[francesales@schaffner.com](mailto:francesales@schaffner.com)

### Germany

#### Schaffner Deutschland GmbH

Schoemperlenstrasse 12B  
76185 Karlsruhe  
T +49 721 56910  
F +49 721 569110  
[germanysales@schaffner.com](mailto:germanysales@schaffner.com)

### India

#### Schaffner India Pvt. Ltd

Unit 59, Level, Mfar Greenheart 7  
Manyata Tech Park, Hebbal Outer Ring Road  
560045 Bangalore  
T +91 80 6781 9805  
F +91 80 6781 9998  
[indiasales@schaffner.com](mailto:indiasales@schaffner.com)

### Italy

#### Schaffner EMC S.r.l.

Via Ticino, 30  
20900 Monza (MB)  
T +39 039 21 41 070  
[italysales@schaffner.com](mailto:italysales@schaffner.com)

### Japan

#### Schaffner EMC K.K.

1-32-12, Kamiyama, Setagaya-ku  
7F Mitsui-seimei Sangenjaya Bldg.  
154-0011 Tokyo  
T +81 3 5712 3650  
F +81 3 5712 3651  
[japansales@schaffner.com](mailto:japansales@schaffner.com)  
<http://www.schaffner.jp>

### Singapore

#### Schaffner EMC Pte Ltd.

#05-09, Kg Ubi Ind. Estate  
408705 Singapore  
T +65 6377 3283  
F +65 6377 3281  
[singaporesales@schaffner.com](mailto:singaporesales@schaffner.com)

### Spain

#### Schaffner EMC España

Calle Caléndula 93, Miniparc III, Edificio E  
El Soto de Moraleja, Alcobendas  
28109 Madrid  
T +34 917 912 900  
F +34 917 912 901  
[spainsales@schaffner.com](mailto:spainsales@schaffner.com)

### Sweden

#### Schaffner EMC AB

Tegeluddsvägen 76, 2tr  
115 28 Stockholm  
T +46 8 5050 2425  
[swedensales@schaffner.com](mailto:swedensales@schaffner.com)  
<http://www.schaffner.com>

### Switzerland

#### Schaffner EMV AG

Nordstrasse 11  
4542 Luterbach  
T +41 32 681 66 26  
[switzerlandsales@schaffner.com](mailto:switzerlandsales@schaffner.com)

### Taiwan R.O.C.

#### Schaffner EMV Ltd.

20 Floor-2, No 97, Section 1, XinTai 5th Road  
22175 XiZhi District New Taipei City 22175  
T +886 2 2697 5500  
F +886 2 2697 5533  
[taiwansales@schaffner.com](mailto:taiwansales@schaffner.com)  
<http://www.schaffner.com.tw>

### Thailand

#### Schaffner EMC Co. Ltd.

Northern Region Industrial Estate  
67 Moo 4 Tambon Ban Klang  
Amphur Muangng P.O. Box 14  
51000 Lamphun  
T +66 53 58 11 04  
F +66 53 58 10 19  
[thailandsales@schaffner.com](mailto:thailandsales@schaffner.com)

### United Kingdom

#### Schaffner Ltd.

5 Ashville Way, Molly Millars Lane  
Wokingham  
RG41 2PL Berkshire  
T +44 118 9770070  
F +44 118 9792969  
[uksales@schaffner.com](mailto:uksales@schaffner.com)

### USA

#### Schaffner EMC Inc.

52 Mayfield Avenue  
08837 Edison, New Jersey  
T +1 800 367 5566  
T +1 732 225 9533  
F +1 732 225 4789  
[usasales@schaffner.com](mailto:usasales@schaffner.com)  
<http://www.schaffnerusa.com>

#### Schaffner North America

6722 Thirlane Road  
24019 Roanoke, Virginia  
T +1 276 228 7943  
F +1 276 228 7953

#### Schaffner North America

823 Fairview Road  
24382 Wytheville, Virginia  
T +1 276 228 7943  
F +1 276 228 7258

To find your local partner within Schaffner's global network: [www.schaffner.com](http://www.schaffner.com)

© 2017 Schaffner Group

The content of this document has been carefully checked and understood. However, neither Schaffner nor its subsidiaries assume any liability whatsoever for any errors or inaccuracies of this document and the consequences thereof. Published specifications are subject to change without notice. Product suitability for any area of application must ultimately be determined by the customer. In all cases, products must never be operated outside their published specifications. Schaffner does not guarantee the availability of all published products. This disclaimer shall be governed by substantive Swiss law and resulting disputes shall be settled by the courts at the place of business of Schaffner Holding AG. Latest publications and a complete disclaimer can be downloaded from the Schaffner website. All trademarks recognized.