



Chipsmall Limited consists of a professional team with an average of over 10 year of expertise in the distribution of electronic components. Based in Hongkong, we have already established firm and mutual-benefit business relationships with customers from,Europe,America and south Asia,supplying obsolete and hard-to-find components to meet their specific needs.

With the principle of “Quality Parts,Customers Priority,Honest Operation,and Considerate Service”,our business mainly focus on the distribution of electronic components. Line cards we deal with include Microchip,ALPS,ROHM,Xilinx,Pulse,ON,Everlight and Freescale. Main products comprise IC,Modules,Potentiometer,IC Socket,Relay,Connector.Our parts cover such applications as commercial,industrial, and automotives areas.

We are looking forward to setting up business relationship with you and hope to provide you with the best service and solution. Let us make a better world for our industry!



## Contact us

Tel: +86-755-8981 8866 Fax: +86-755-8427 6832

Email & Skype: info@chipsmall.com Web: www.chipsmall.com

Address: A1208, Overseas Decoration Building, #122 Zhenhua RD., Futian, Shenzhen, China



# Bookstyle EMC/EMI Filter for Motor Drives



- Exceptional broadband attenuation performance from 10 kHz up to 30 MHz
- Slim and user-friendly book-style design with touch-safe terminal blocks for minimum space and maximum safety
- Enables compliance with Class B limits



### Performance indicators

Attenuation performance



Rated current [A]

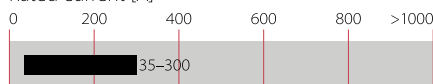

### Approvals



(FN 3100 up to 150 A)

### Features and benefits

- High performance filter for mainly industrial motor drive applications with significant interference levels
- Attenuation performance for Class B compliance in applications comprising multiple motor drives (e.g. machine tool with up to 8 driving axes with ~10 to 20 m motor cable each)
- Broadband filter performance with low frequency attenuation down to 10 kHz for reliable suppression of conducted interference
- Slim book-style shape requiring minimum cabinet space and allowing convenient installation right beside the motor drive
- Touch-safe terminal blocks provide unsurpassed electrical safety and contacting cross section according to EN 60204-1 installation standard
- For even better filter specifications, please consider FN 3120 H series from Schaffner

### Technical specifications

<b>Maximum continuous operating voltage</b>	3x 520/300 VAC
<b>Operating frequency</b>	DC to 60 Hz
<b>Rated currents</b>	35 to 300 A @ 50°C
<b>High potential test voltage</b>	P → E 2750 VDC for 2 sec P → P 2250 VDC for 2 sec
<b>Protection category</b>	IP 20
<b>Overload capability</b>	4x rated current at switch on, 1.5x rated current for 1 minute, once per hour
<b>Temperature range (operation and storage)</b>	-25°C to +100°C (25/100/21)
<b>Flammability corresponding to</b>	UL 94 V-2 or better
<b>Design corresponding to</b>	UL 1283, CSA 22.2 No. 8 1986, IEC/EN 60939
<b>MTBF @ 50°C/400 V (Mil-HB-217F)</b>	>400,000 hours



### Typical applications

- Conventional motor drives with long motor cables and high interference levels
- Four quadrant motor drives and servo drives with energy regeneration mode (in combination with a suitable line reactor or LCL filter)
- Industrial applications comprising power conversion devices, such as machinery, machine tools and process automation equipment
- Uninterruptible power supplies (UPS)
- Converters for renewable energy generation
- Thyristor drives
- Elevators and cranes

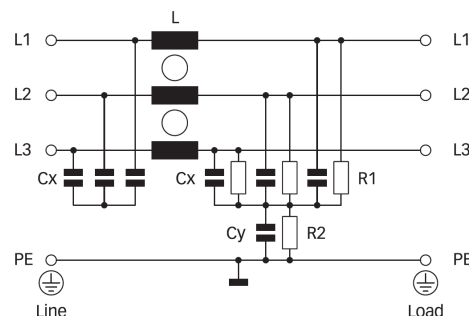
### Typical electrical schematic



### Filter selection table

Filter	Rated current @ 50°C (40°C)	Typical drive power rating*	Leakage current** @ 520 VAC/50 Hz	Power loss @ 25°C/50 Hz	Input/Output connections		Weight
	[A]	[kW]	[mA]	[W]			[kg]
<b>FN 3100-35-33</b>	35 (38.4)	22	6.8	11.8	-33		2.3
<b>FN 3100-50-34</b>	50 (54.8)	30	9.3	18.0	-34		3.4
<b>FN 3100-80-35</b>	80 (87.6)	45	10.0	25.9	-35		5.0
<b>FN 3100-110-35</b>	110 (120.5)	55	10.0	32.7	-35		5.4
<b>FN 3100-150-40</b>	150 (164.3)	75	10.0	50.6	-40		8.5
<b>FN 3100-200-40</b>	200 (219)	110	10.0	67.2	-40		9.1
<b>FN 3100-230-40</b>	230 (230)	132	10.0	36.5	-40		9.2
<b>FN 3100-300-99</b>	300 (329)	160	10.0	54.0		-99	11.8

\* Calculated at rated current, 480 VAC and cos phi=0.8. The exact value depends upon the efficiency of the drive, the motor and the entire application.

\*\* Standardized calculated leakage current acc. IEC60939 under normal operating conditions.

### Typical filter attenuation

Per CISPR 17; A=50 Ω/50 Ω sym; B=50 Ω/50 Ω asym; C=0.1 Ω/100 Ω sym; D=100 Ω/0.1 Ω sym

35 to 80 A types

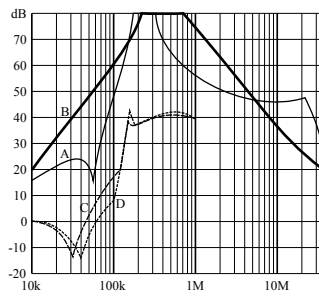

110 and 150 A types

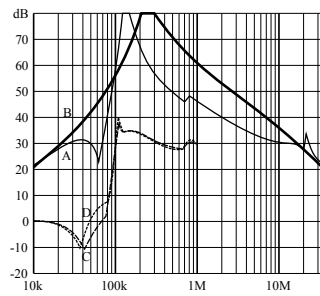

200 A types

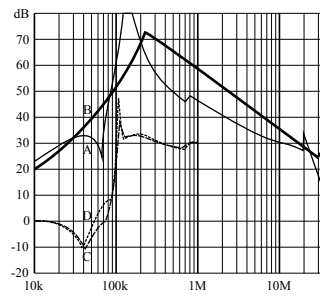

230 and 300 A types

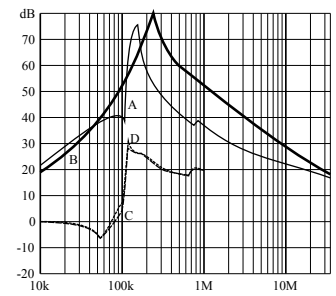

## Mechanical data

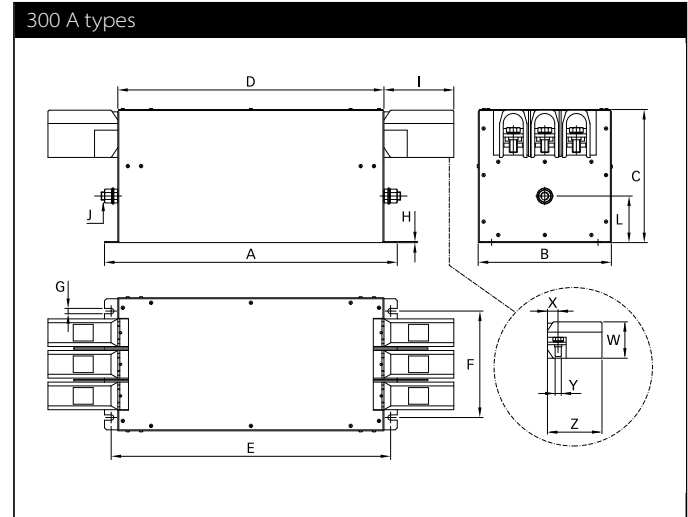
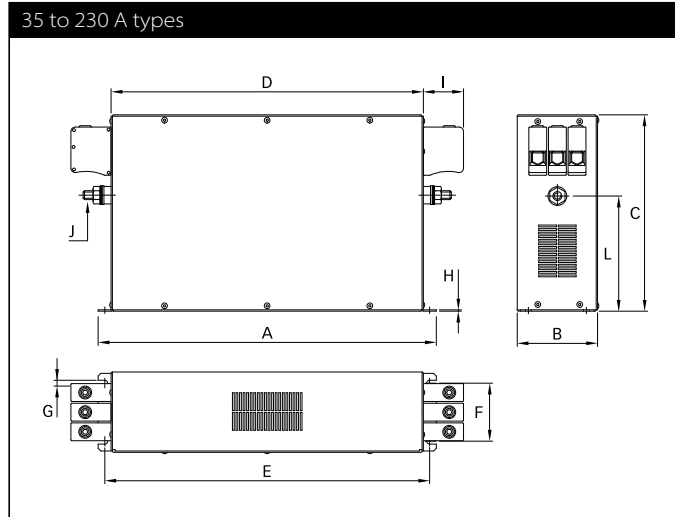

## Dimensions

	35 A	50 A	80 A	110 A	150 A	200 A	230 A	300 A
<b>A</b>	335	329	379	379	438	438	438	440
<b>B</b>	60	80	90	90	110	110	110	200
<b>C</b>	150	185	220	220	240	240	240	200
<b>D</b>	305	300	350	350	400	400	400	400
<b>E</b>	320	314	364	364	413	413	413	420
<b>F</b>	35	55	65	65	80	80	80	160
<b>G</b>	6.5	6.5	6.5	6.5	6.5	6.5	6.5	8
<b>H</b>	1	1.5	1.5	1.5	4	4	4	1.5
<b>I</b>	25	39	45	45	51	51	51	105
<b>J</b>	M5	M6	M10	M10	M10	M10	M10	M12
<b>L</b>	93.5	107	129	129	108	108	108	70
<b>W</b>								71.5
<b>X</b>								~22
<b>Y</b>								M12
<b>Y</b>								~105

All dimensions in mm; 1 inch = 25.4 mm  
Tolerances according to: ISO 2768-m/EN 22768-m

## Filter input/output connector cross sections

	-33	-34	-35	-40	-99
<b>Solid wire</b>	16 mm <sup>2</sup>	35 mm <sup>2</sup>	50 mm <sup>2</sup>	95 mm <sup>2</sup>	-
<b>Flex wire</b>	10 mm <sup>2</sup>	25 mm <sup>2</sup>	50 mm <sup>2</sup>	95 mm <sup>2</sup>	150 mm <sup>2</sup>
<b>AWG type wire</b>	AWG 6	AWG 2	AWG 1/0	AWG 4/0	AWG 6/0
<b>Recommended torque</b>	1.5 - 1.8 Nm	4.0 - 4.5 Nm	7 - 8 Nm	17 - 20 Nm	27 - 30 Nm

Please visit [www.schaffner.com](http://www.schaffner.com) to find more details on filter connectors.



## Headquarters, global innovation and development

### Switzerland

#### Schaffner Group

Nordstrasse 11  
4542 Luterbach  
T +41 32 681 66 26  
[info@schaffner.com](mailto:info@schaffner.com)  
[www.schaffner.com](http://www.schaffner.com)



## Sales and application centers

### China

**Schaffner EMC Ltd. Shanghai**  
T20-3 C, No 565 Chuangye Road,  
Pudong district  
201201 Shanghai  
T +86 21 3813 9500  
[cschina@schaffner.com](mailto:cschina@schaffner.com)  
[www.schaffner.com.cn](http://www.schaffner.com.cn)

### Finland

**Schaffner Oy**  
Sauvonrinne 19 H  
08500 Lohja  
T +358 50 468 7284  
[finlandsales@schaffner.com](mailto:finlandsales@schaffner.com)

### France

**Schaffner EMC S.A.S.**  
16-20 Rue Louis Rameau  
95875 Bezons  
T +33 1 34 34 30 60  
F +33 1 39 47 02 28  
[francesales@schaffner.com](mailto:francesales@schaffner.com)

### Germany

**Schaffner Deutschland GmbH**  
Schoemperlenstrasse 12B  
76185 Karlsruhe  
T +49 721 56910  
F +49 721 569110  
[germanysales@schaffner.com](mailto:germanysales@schaffner.com)

### India

**Schaffner India Pvt. Ltd**  
Unit 59, Level, Mfar Greenheart 7  
Manyata Tech Park, Hebbal Outer Ring Road  
560045 Bangalore  
T +91 80 6781 9805  
F +91 80 6781 9998  
[indiasales@schaffner.com](mailto:indiasales@schaffner.com)

### Italy

**Schaffner EMC S.r.l.**  
Via Ticino, 30  
20900 Monza (MB)  
T +39 039 21 41 070  
[italysales@schaffner.com](mailto:italysales@schaffner.com)

### Japan

**Schaffner EMC K.K.**  
1-32-12, Kamiyama, Setagaya-ku  
7F Mitsui-seimei Sengenjaya Bldg.  
154-0011 Tokyo  
T +81 3 5712 3650  
F +81 3 5712 3651  
[japansales@schaffner.com](mailto:japansales@schaffner.com)  
[www.schaffner.jp](http://www.schaffner.jp)

### Singapore

**Schaffner EMC Pte Ltd.**  
#05-09, Kg Ubi Ind. Estate  
408705 Singapore  
T +65 6377 3283  
F +65 6377 3281  
[singaporesales@schaffner.com](mailto:singaporesales@schaffner.com)

### Spain

**Schaffner EMC España**  
Calle Caléndula 93, Miniparc III, Edificio E  
El Soto de Moraleja, Alcobendas  
28109 Madrid  
T +34 917 912 900  
F +34 917 912 901  
[spainsales@schaffner.com](mailto:spainsales@schaffner.com)

### Sweden

**Schaffner EMC AB**  
Tegeluddsvägen 76, 2tr  
115 28 Stockholm  
T +46 8 5050 2425  
[swedensales@schaffner.com](mailto:swedensales@schaffner.com)  
[www.schaffner.com](http://www.schaffner.com)

### Switzerland

**Schaffner EMV AG**  
Nordstrasse 11  
4542 Luterbach  
T +41 32 681 66 26  
[switzerlandsales@schaffner.com](mailto:switzerlandsales@schaffner.com)

### Taiwan R.O.C.

**Schaffner EMV Ltd.**  
20 Floor-2, No 97, Section 1, XinTai 5th Road  
22175 XiZhi District New Taipei City 22175  
T +886 2 2697 5500  
F +886 2 2697 5533  
[taiwansales@schaffner.com](mailto:taiwansales@schaffner.com)  
[www.schaffner.com.tw](http://www.schaffner.com.tw)

### Thailand

**Schaffner EMC Co. Ltd.**  
Northern Region Industrial Estate  
67 Moo 4 Tambon Ban Klang  
Amphur Muangng P.O. Box 14  
51000 Lamphun  
T +66 53 58 11 04  
F +66 53 58 10 19  
[thailandsales@schaffner.com](mailto:thailandsales@schaffner.com)

### United Kingdom

**Schaffner Ltd.**  
5 Ashville Way, Molly Millars Lane  
Wokingham  
RG41 2PL Berkshire  
T +44 118 9770070  
F +44 118 9792969  
[uksales@schaffner.com](mailto:uksales@schaffner.com)

### USA

**Schaffner EMC Inc.**  
52 Mayfield Avenue  
08837 Edison, New Jersey  
T +1 800 367 5566  
T +1 732 225 9533  
F +1 732 225 4789  
[usasales@schaffner.com](mailto:usasales@schaffner.com)  
[www.schaffnerusa.com](http://www.schaffnerusa.com)

### Schaffner North America

6722 Thirlane Road  
24019 Roanoke, Virginia  
T +1 276 228 7943  
F +1 276 228 7953

### Schaffner North America

823 Fairview Road  
24382 Wytheville, Virginia  
T +1 276 228 7943  
F +1 276 228 7258

To find your local partner within Schaffner's global network: [www.schaffner.com](http://www.schaffner.com)

© 2018 Schaffner Group

The content of this document has been carefully checked and understood. However, neither Schaffner nor its subsidiaries assume any liability whatsoever for any errors or inaccuracies of this document and the consequences thereof. Published specifications are subject to change without notice. Product suitability for any area of application must ultimately be determined by the customer. In all cases, products must never be operated outside their published specifications. Schaffner does not guarantee the availability of all published products. This disclaimer shall be governed by substantive Swiss law and resulting disputes shall be settled by the courts at the place of business of Schaffner Holding AG. Latest publications and a complete disclaimer can be downloaded from the Schaffner website. All trademarks recognized.