



Chipsmall Limited consists of a professional team with an average of over 10 year of expertise in the distribution of electronic components. Based in Hongkong, we have already established firm and mutual-benefit business relationships with customers from,Europe,America and south Asia,supplying obsolete and hard-to-find components to meet their specific needs.

With the principle of “Quality Parts,Customers Priority,Honest Operation,and Considerate Service”,our business mainly focus on the distribution of electronic components. Line cards we deal with include Microchip,ALPS,ROHM,Xilinx,Pulse,ON,Everlight and Freescale. Main products comprise IC,Modules,Potentiometer,IC Socket,Relay,Connector.Our parts cover such applications as commercial,industrial, and automotives areas.

We are looking forward to setting up business relationship with you and hope to provide you with the best service and solution. Let us make a better world for our industry!



## Contact us

Tel: +86-755-8981 8866 Fax: +86-755-8427 6832

Email & Skype: info@chipsmall.com Web: www.chipsmall.com

Address: A1208, Overseas Decoration Building, #122 Zhenhua RD., Futian, Shenzhen, China



# General Purpose EMC Filter



- EMC solution for industrial inverters and motor drives
- Rated currents from 8 to 280 A
- Selectable voltage level of 440 V and 520 V
- High differential and common-mode attenuation



### Performance indicators

Attenuation performance



Rated current [A]

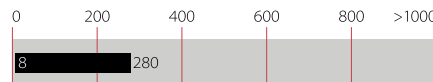

## Technical specifications

<b>Maximum continuous operating voltage</b>	3x 440/250 VAC (FN 351) 3x 520/300 VAC (FN 351 H)
<b>Operating frequency</b>	DC to 60 Hz
<b>Rated currents</b>	8 to 280 A @ 40°C
<b>High potential test voltage</b>	P → E 2600 VDC for 2 sec (FN 351) P → P 1900 VDC for 2 sec (FN 351) P → E 2750 VDC for 2 sec (FN 351 H) P → P 2250 VDC for 2 sec (FN 351 H)
<b>Protection category</b>	IP 20
<b>Overload capability</b>	4x rated current at switch on, 1.5x rated current for 1 minute, once per hour
<b>Temperature range (operation and storage)</b>	-25°C to +85°C (25/085/21) (FN 351)
<b>Temperature range (operation and storage)</b>	-25°C to +100°C (25/100/21) (FN 351 H)
<b>Flammability corresponding to</b>	UL 94 V-2 or better
<b>Design corresponding to</b>	UL 1283, CSA 22.2 No. 8 1986, IEC/EN 60939
<b>MTBF @ 40°C/400 V (Mil-HB-217F)</b>	135,000 hours

### Approvals



UR / CSA: FN 351 up to 110 A; cCSAus: FN 351 H up to 110 A

### Features and benefits

- Broad range of power ratings for fast and convenient filter selection
- Available as 440 VAC (FN 351) and 520 VAC (FN 351 H) versions for network-specific applications
- FN 351 filters provide a broadband common and differential-mode attenuation performance, which remains available also when high interference levels are present
- Solid, touch-safe filter terminals contribute to overall equipment safety
- Introduced as one of the very first motor drive EMC filters in the market, FN 351 has been widely imitated and has successfully proven its function over more than 10 years

### Typical applications

- Three-phase motor drives
- Inverters and converters
- Industrial automation equipment
- UPS
- SMPS
- General purpose three-phase filtering

### Typical electrical schematic

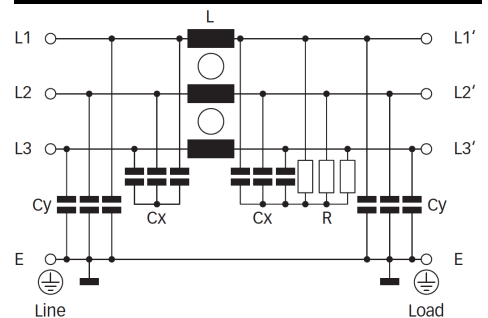

### Filter selection table

Filter*	Rated current @ 40°C (25°C)	Typical drive power rating**	Leakage current*** @ 440/520 VAC/50 Hz	Power loss @ 25°C/50 Hz	Input/Output connections		Weight [kg]
	[A]	[kW]	[mA]	[W]			
FN 351-8-29	8 (9.2)	3	0.3	7	-29		0.8
FN 351-16-29	16 (18.5)	5.5	0.3	8	-29		1.3
FN 351-25-33	25 (28.9)	11	3.2	8	-33		1.4
FN 351-36-33	36 (41.6)	15	3.2	9	-33		1.5
FN 351-50-..	50 (57.7)	22	3.5	11	-33		1.6
FN 351-64-..	64 (73.9)	30	3.5	15	-33	-34	1.7
FN 351-80-34	80 (92.3)	37	3.7	23	-34		5.6
FN 351-110-35	110 (127)	55	3.7	25	-35		5.8
FN 351-180-36	180 (208)	90	3.7	49	-36		13.0
FN 351-280-37	280 (323)	132	4.3	70	-37		28.0
FN 351 H-8-29	8 (9.2)	4	0.3	7	-29		1.1
FN 351 H-16-29	16 (18.5)	7.5	0.3	8	-29		1.3
FN 351 H-25-33	25 (28.9)	15	3.8	8	-33		1.4
FN 351 H-36-33	36 (41.6)	18.5	3.8	9	-33		1.5
FN 351 H-50-..	50 (57.7)	30	3.8	11	-33		1.6
FN 351 H-64-33	64 (73.9)	37	3.8	15	-33		1.7
FN 351 H-80-34	80 (92.3)	45	4.4	23	-34		5.6
FN 351 H-110-35	110 (127)	75	4.4	25	-35		5.8
FN 351 H-180-36	180 (208)	110	4.4	49	-36		13.0
FN 351 H-280-37	280 (323)	160	5.1	70	-37		28.0

\* To compile a complete part number, please replace the .. with the required I/O connection style.

\*\* Calculated at rated current, 400 VAC (FN 351)/480 VAC (FN 351 H) and cos phi=0.8. The exact value depends upon the efficiency of the drive, the motor and the entire application.

\*\*\* Standardized calculated leakage current acc. IEC60939 under normal operating conditions (FN 351 at 440 VAC and FN 351H at 520 VAC).

### Typical filter attenuation

Per CISPR 17; A=50 Ω/50 Ω sym; B=50Ω/50Ω asym; C=0.1 Ω/100 Ω sym; D=100 Ω/0.1 Ω sym

8 A types

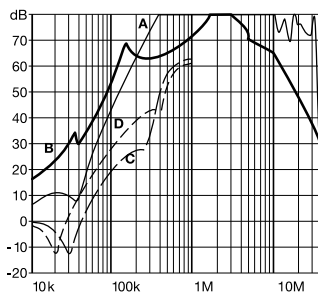

16 A types

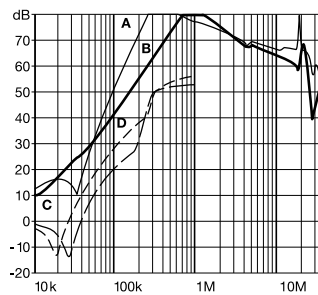

25 A types

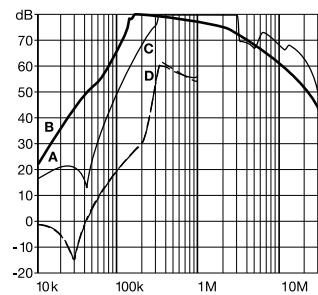

36 and 50 A types

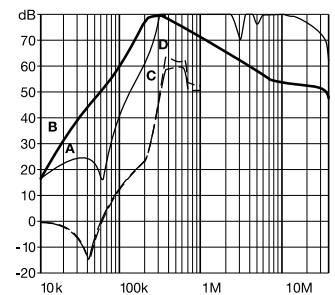

64 A types

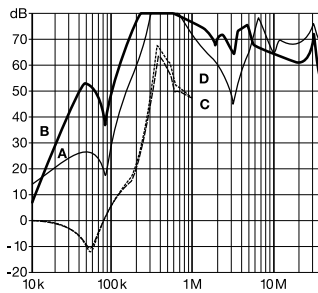

80 and 110 A types

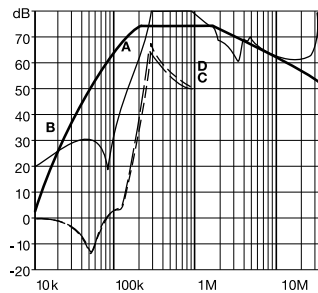

180 A types

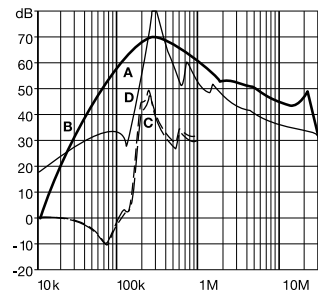

280 A types

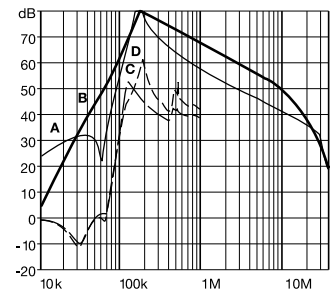

### Mechanical data

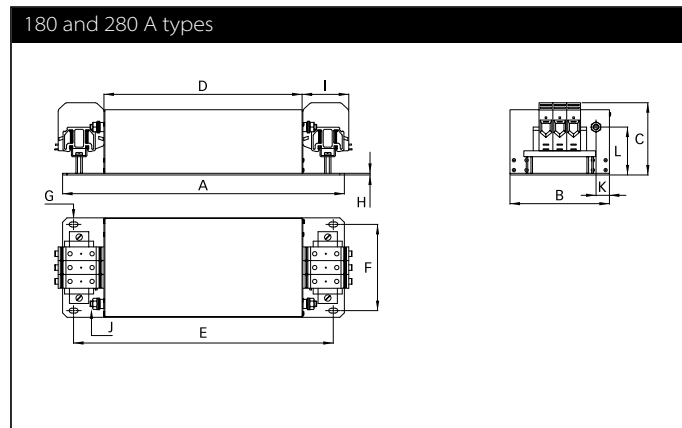
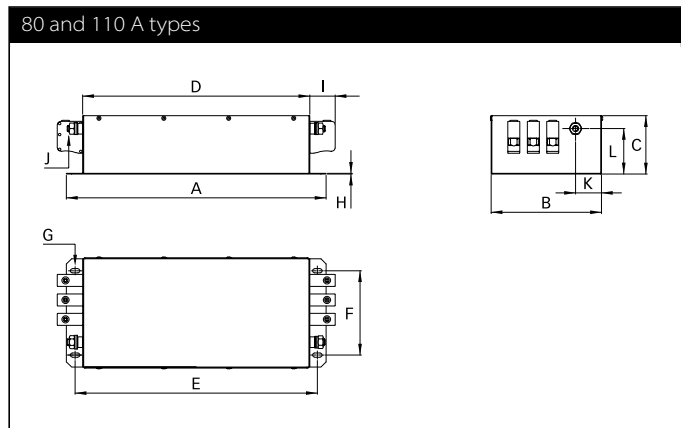
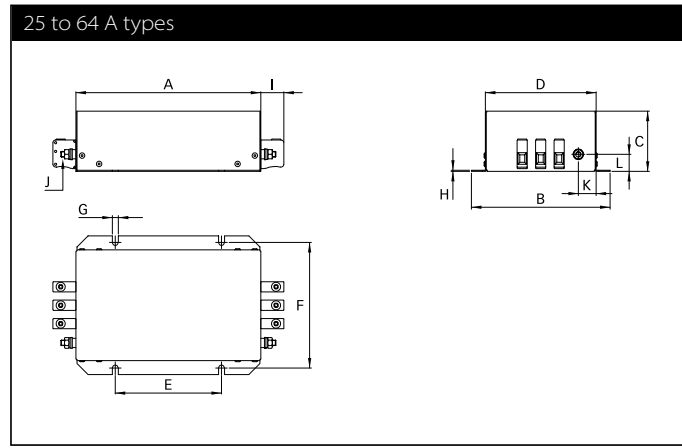
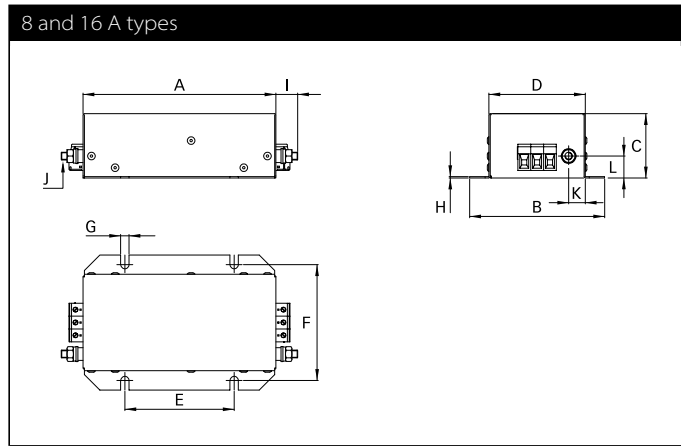







## Dimensions

	8 A	8 A (-H)	16 A	25 A	36 A	50 A (-33)	50 A (-34)	64 A (-33)	64 A (-34)	80 A	110 A	180 A	280 A
<b>A</b>	180	200	200	200	200	200	200	200	200	400	400	510	700
<b>B</b>	115	150	150	150	150	150	150	150	150	170	170	180	260
<b>C</b>	60	65	65	65	65	65	65	65	80	90	90	133	155
<b>D</b>	85	120	120	120	120	120	120	120	120	350	350	360	530
<b>E</b>	115	115	115	115	115	115	115	115	115	373	373	470	660
<b>F</b>	100	136	136	136	136	136	136	136	136	130	130	156	220
<b>G</b>	6.5	6.5	6.5	6.5	6.5	6.5	6.5	6.5	6.5	15 x 6.5	15 x 6.5	16 x 9	16 x 9
<b>H</b>	1	1	1	1	1	1	1	1	1	1	1	4	4
<b>I</b>	17	17	17	25	25	25	39	25	39	39	45	83	110
<b>J</b>	M6	M6	M6	M6	M6	M6	M6	M6	M6	M10	M10	M10	M10
<b>K</b>	13	19.25	19.25	19.25	19.25	19.25	18.75	19.25	18.75	40	40	25	30
<b>L</b>	17	17	17	18.4	18.4	18.4	17	18.4	17	70	70	85	100

All dimensions in mm; 1 inch = 25.4 mm  
Tolerances according: ISO 2768-m / EN 22768-m

## Filter input/output connector cross sections

	-29	-33	-34	-35	-36	-37
						
<b>Solid wire</b>	6 mm <sup>2</sup>	16 mm <sup>2</sup>	35 mm <sup>2</sup>	50 mm <sup>2</sup>	95 mm <sup>2</sup>	150 mm <sup>2</sup>
<b>Flex wire</b>	4 mm <sup>2</sup>	10 mm <sup>2</sup>	25 mm <sup>2</sup>	50 mm <sup>2</sup>	95 mm <sup>2</sup>	150 mm <sup>2</sup>
<b>AWG type wire</b>	AWG 10	AWG 6	AWG 2	AWG 1/0	AWG 4/0	AWG 6/0
<b>Recommended torque</b>	0.6-0.8 Nm	1.5-1.8 Nm	4.0-4.5 Nm	7-8 Nm	17-20 Nm	27-30 Nm

Please visit [www.schaffner.com](http://www.schaffner.com) to find more details on filter connectors.



## Headquarters, global innovation and development

### Switzerland

#### Schaffner Group

Nordstrasse 11  
4542 Luterbach  
T +41 32 681 66 26  
[info@schaffner.com](mailto:info@schaffner.com)  
[www.schaffner.com](http://www.schaffner.com)



## Sales and application centers

### China

#### Schaffner EMC Ltd. Shanghai

T20-3 C, No 565 Chuangye Road,  
Pudong district  
201201 Shanghai  
T +86 21 3813 9500  
[cschina@schaffner.com](mailto:cschina@schaffner.com)  
[www.schaffner.com.cn](http://www.schaffner.com.cn)

### Finland

#### Schaffner Oy

Sauvonrinne 19 H  
08500 Lohja  
T +358 50 468 7284  
[finlandsales@schaffner.com](mailto:finlandsales@schaffner.com)

### France

#### Schaffner EMC S.A.S.

16-20 Rue Louis Rameau  
95875 Bezons  
T +33 1 34 34 30 60  
F +33 1 39 47 02 28  
[francesales@schaffner.com](mailto:francesales@schaffner.com)

### Germany

#### Schaffner Deutschland GmbH

Schoemperlenstrasse 12B  
76185 Karlsruhe  
T +49 721 56910  
F +49 721 569110  
[germanysales@schaffner.com](mailto:germanysales@schaffner.com)

### India

#### Schaffner India Pvt. Ltd

REGUS WORLD TRADE CENTRE  
WTC, 22nd Floor Unit No 2238, Brigade  
Gateway Campus, 26/1, Dr. Rajkumar Road  
Mallechwaram (W)  
560055 Bangalore  
T +91 80 67935355  
[indiasales@schaffner.com](mailto:indiasales@schaffner.com)

### Italy

#### Schaffner EMC S.r.l.

Via Ticino, 30  
20900 Monza (MB)  
T +39 039 21 41 070  
[italysales@schaffner.com](mailto:italysales@schaffner.com)

### Japan

#### Schaffner EMC K.K.

1-32-12, Kamiyama, Setagaya-ku  
7F Mitsui-seimei Sangenjaya Bldg.  
154-0011 Tokyo  
T +81 3 5712 3650  
F +81 3 5712 3651  
[japansales@schaffner.com](mailto:japansales@schaffner.com)  
[www.schaffner.jp](http://www.schaffner.jp)

### Singapore

#### Schaffner EMC Pte Ltd.

#05-09, Kg Ubi Ind. Estate  
408705 Singapore  
T +65 6377 3283  
F +65 6377 3281  
[singaporesales@schaffner.com](mailto:singaporesales@schaffner.com)

### Spain

#### Schaffner EMC España

Calle Caléndula 93, Miniparc III, Edificio E  
El Soto de Moraleja, Alcobendas  
28109 Madrid  
T +34 917 912 900  
F +34 917 912 901  
[spainsales@schaffner.com](mailto:spainsales@schaffner.com)

### Sweden

#### Schaffner EMC AB

Tegeluddsvägen 76, 2tr  
115 28 Stockholm  
T +46 8 5050 2425  
[swedensales@schaffner.com](mailto:swedensales@schaffner.com)  
[www.schaffner.com](http://www.schaffner.com)

### Switzerland

#### Schaffner EMV AG

Nordstrasse 11  
4542 Luterbach  
T +41 32 681 66 26  
[switzerlandsales@schaffner.com](mailto:switzerlandsales@schaffner.com)

### Taiwan R.O.C.

#### Schaffner EMV Ltd.

20 Floor-2, No 97, Section 1, XinTai 5th Road  
22175 XiZhi District New Taipei City 22175  
T +886 2 2697 5500  
F +886 2 2697 5533  
[taiwansales@schaffner.com](mailto:taiwansales@schaffner.com)  
[www.schaffner.com.tw](http://www.schaffner.com.tw)

### Thailand

#### Schaffner EMC Co. Ltd.

Northern Region Industrial Estate  
67 Moo 4 Tambon Ban Klang  
Amphur Muangng P.O. Box 14  
51000 Lamphun  
T +66 53 58 11 04  
F +66 53 58 10 19  
[thailandsales@schaffner.com](mailto:thailandsales@schaffner.com)

### United Kingdom

#### Schaffner Ltd.

5 Ashville Way, Molly Millars Lane  
Wokingham  
RG41 2PL Berkshire  
T +44 118 9770070  
F +44 118 9792969  
[uksales@schaffner.com](mailto:uksales@schaffner.com)

### USA

#### Schaffner EMC Inc.

52 Mayfield Avenue  
08837 Edison, New Jersey  
T +1 800 367 5566  
T +1 732 225 9533  
F +1 732 225 4789  
[usasales@schaffner.com](mailto:usasales@schaffner.com)  
[www.schaffnerusa.com](http://www.schaffnerusa.com)

#### Schaffner North America

6722 Thirlane Road  
24019 Roanoke, Virginia  
T +1 276 228 7943  
F +1 276 228 7953

#### Schaffner North America

823 Fairview Road  
24382 Wytheville, Virginia  
T +1 276 228 7943  
F +1 276 228 7258

To find your local partner within Schaffner's global network: [www.schaffner.com](http://www.schaffner.com)

© 2018 Schaffner Group

The content of this document has been carefully checked and understood. However, neither Schaffner nor its subsidiaries assume any liability whatsoever for any errors or inaccuracies of this document and the consequences thereof. Published specifications are subject to change without notice. Product suitability for any area of application must ultimately be determined by the customer. In all cases, products must never be operated outside their published specifications. Schaffner does not guarantee the availability of all published products. This disclaimer shall be governed by substantive Swiss law and resulting disputes shall be settled by the courts at the place of business of Schaffner Holding AG. Latest publications and a complete disclaimer can be downloaded from the Schaffner website. All trademarks recognized.