



Chipsmall Limited consists of a professional team with an average of over 10 year of expertise in the distribution of electronic components. Based in Hongkong, we have already established firm and mutual-benefit business relationships with customers from,Europe,America and south Asia,supplying obsolete and hard-to-find components to meet their specific needs.

With the principle of “Quality Parts,Customers Priority,Honest Operation,and Considerate Service”,our business mainly focus on the distribution of electronic components. Line cards we deal with include Microchip,ALPS,ROHM,Xilinx,Pulse,ON,Everlight and Freescale. Main products comprise IC,Modules,Potentiometer,IC Socket,Relay,Connector.Our parts cover such applications as commercial,industrial, and automotives areas.

We are looking forward to setting up business relationship with you and hope to provide you with the best service and solution. Let us make a better world for our industry!



Contact us

Tel: +86-755-8981 8866 Fax: +86-755-8427 6832

Email & Skype: info@chipsmall.com Web: www.chipsmall.com

Address: A1208, Overseas Decoration Building, #122 Zhenhua RD., Futian, Shenzhen, China





Is Now Part of



ON Semiconductor®

To learn more about ON Semiconductor, please visit our website at
www.onsemi.com

ON Semiconductor and the ON Semiconductor logo are trademarks of Semiconductor Components Industries, LLC dba ON Semiconductor or its subsidiaries in the United States and/or other countries. ON Semiconductor owns the rights to a number of patents, trademarks, copyrights, trade secrets, and other intellectual property. A listing of ON Semiconductor's product/patent coverage may be accessed at www.onsemi.com/site/pdf/Patent-Marking.pdf. ON Semiconductor reserves the right to make changes without further notice to any products herein. ON Semiconductor makes no warranty, representation or guarantee regarding the suitability of its products for any particular purpose, nor does ON Semiconductor assume any liability arising out of the application or use of any product or circuit, and specifically disclaims any and all liability, including without limitation special, consequential or incidental damages. Buyer is responsible for its products and applications using ON Semiconductor products, including compliance with all laws, regulations and safety requirements or standards, regardless of any support or applications information provided by ON Semiconductor. "Typical" parameters which may be provided in ON Semiconductor data sheets and/or specifications can and do vary in different applications and actual performance may vary over time. All operating parameters, including "Typicals" must be validated for each customer application by customer's technical experts. ON Semiconductor does not convey any license under its patent rights nor the rights of others. ON Semiconductor products are not designed, intended, or authorized for use as a critical component in life support systems or any FDA Class 3 medical devices or medical devices with a same or similar classification in a foreign jurisdiction or any devices intended for implantation in the human body. Should Buyer purchase or use ON Semiconductor products for any such unintended or unauthorized application, Buyer shall indemnify and hold ON Semiconductor and its officers, employees, subsidiaries, affiliates, and distributors harmless against all claims, costs, damages, and expenses, and reasonable attorney fees arising out of, directly or indirectly, any claim of personal injury or death associated with such unintended or unauthorized use, even if such claim alleges that ON Semiconductor was negligent regarding the design or manufacture of the part. ON Semiconductor is an Equal Opportunity/Affirmative Action Employer. This literature is subject to all applicable copyright laws and is not for resale in any manner.

FODM452, FODM453

5-Pin Mini Flat Package High Speed Transistor Optocoupler

Features

- Compact 5-pin mini flat package
- High speed-1 MBit/s
- Superior CMR-15kV/μs at $V_{CM} = 1500V$ (FODM453)
- Performance guaranteed over temperature (0–70°C)
- U.L. recognized (File # E90700)
- VDE0884 recognized (File # 136480)
 - Ordering option V, e.g., FODM452V
- 260°C reflow capability for Pb-free assembly

Applications

- Line receivers
- Pulse transformer replacement
- Output interface to CMOS-LSTTL-TTL
- Wide bandwidth analog coupling

Description

The FODM452 and FODM453 optocouplers consist of an AlGaAs LED optically coupled to a high speed photo-detector transistor. The devices are housed in a compact 5-pin mini flat package for optimum mounting density. The FODM453 features a high CMR rating for optimum common mode transient immunity.

Related Resources

- www.fairchildsemi.com/products/opto/
- www.fairchildsemi.com/pf/FO/FODM611.html
- www.fairchildsemi.com/pf/FO/FODM8061.html
- www.fairchildsemi.com/pf/FO/FODM8071.html

Functional Schematic

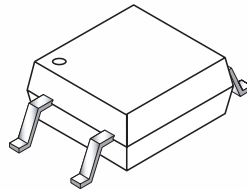
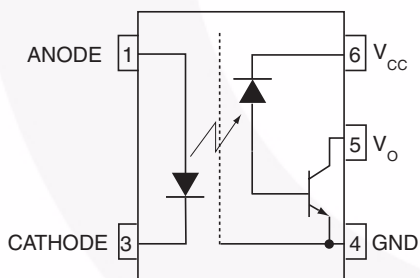

Truth Table

| LED | Output |
|-----|--------|
| Off | High |
| On | Low |

Pin Definitions

| Number | Name | Function Description |
|--------|----------|-----------------------|
| 1 | ANODE | Anode |
| 3 | CATHODE | Cathode |
| 4 | GND | Output Ground |
| 5 | V_O | Output Voltage |
| 6 | V_{CC} | Output Supply Voltage |

Safety and Insulation Ratings for Mini-Flat Package (SO5 Pin)

As per IEC60747-5-2 (Pending Certification). This optocoupler is suitable for “safe electrical insulation” only within the safety limit data. Compliance with the safety ratings shall be ensured by means of protective circuits.

| Symbol | Parameter | Min. | Typ. | Max. | Unit |
|------------|--|--------|----------|------|------------|
| | Installation Classifications per DIN VDE 0110/1.89 Table 1 | | | | |
| | For rated main voltage < 150Vrms | | I-IV | | |
| | For rated main voltage < 300Vrms | | I-III | | |
| | Climatic Classification | | 40/85/21 | | |
| | Pollution Degree (DIN VDE 0110/1.89) | | 2 | | |
| CTI | Comparative Tracking Index | 175 | | | |
| V_{PR} | Input to Output Test Voltage, Method b, $V_{IORM} \times 1.875 = V_{PR}$, 100% Production Test with $t_m = 1$ sec, Partial Discharge < 5 pC | 1060 | | | |
| V_{PR} | Input to Output Test Voltage, Method a, $V_{IORM} \times 1.5 = V_{PR}$, Type and Sample Test with $t_m = 60$ sec, Partial Discharge < 5 pC | 848 | | | |
| V_{IORM} | Max Working Insulation Voltage | 565 | | | V_{peak} |
| V_{IOTM} | Highest Allowable Over Voltage | 4000 | | | V_{peak} |
| | External Creepage | 5.0 | | | mm |
| | External Clearance | 5.0 | | | mm |
| | Insulation thickness | 0.5 | | | mm |
| T_{Case} | Safety Limit Values, Maximum Values allowed in the event of a failure, Case Temperature | 150 | | | °C |
| R_{IO} | Insulation Resistance at T_S , $V_{IO} = 500V$ | 10^9 | | | Ω |

Absolute Maximum Ratings ($T_A = 25^\circ\text{C}$ unless otherwise noted)

Stresses exceeding the absolute maximum ratings may damage the device. The device may not function or be operable above the recommended operating conditions and stressing the parts to these levels is not recommended. In addition, extended exposure to stresses above the recommended operating conditions may affect device reliability. The absolute maximum ratings are stress ratings only.

| Symbol | Parameter | Value | Units |
|-----------------|--|-------------|------------------|
| T_{STG} | Storage Temperature | -40 to +125 | $^\circ\text{C}$ |
| T_{OPR} | Operating Temperature | -40 to +85 | $^\circ\text{C}$ |
| EMITTER | | | |
| I_F (avg) | DC/Average Forward Input Current | 25 | mA |
| I_F (pk) | Peak Forward Input Current (50% duty cycle, 1ms P.W.) | 50 | mA |
| I_F (trans) | Peak Transient Input Current ($\leq 1\mu\text{s}$ P.W., 300pps) | 1.0 | A |
| V_R | Reverse Input Voltage | 5 | V |
| P_D | Input Power Dissipation (No derating required over specified operating temp range) | 45 | mW |
| DETECTOR | | | |
| I_O (avg) | Average Output Current | 8 | mA |
| I_O (pk) | Peak Output Current | 16 | mA |
| V_{CC} | Supply Voltage | -0.5 to 30 | V |
| V_O | Output Voltage | -0.5 to 20 | V |
| P_D | Output Power Dissipation (No derating required over specified operating temp range) | 100 | mW |

Electrical Characteristics (T_A = 0 to 70°C unless otherwise specified)

Individual Component Characteristics

| Symbol | Parameter | Test Conditions | Min. | Typ.* | Max. | Unit |
|----------------------------------|--|--|------|-------|------|-------|
| EMITTER | | | | | | |
| V _F | Input Forward Voltage | I _F = 16mA, T _A = 25°C | | 1.60 | 1.7 | V |
| | | I _F = 16mA | | | 1.8 | |
| B _{VR} | Input Reverse Breakdown Voltage | I _R = 10μA | 5.0 | | | V |
| ΔV _F /ΔT _A | Temperature Coefficient of Forward Voltage | I _F = 16mA | | -1.8 | | mV/°C |
| DETECTOR | | | | | | |
| I _{OH} | Logic High Output Current | I _F = 0mA, V _O = V _{CC} = 5.5V, T _A = 25°C | | .001 | 0.5 | μA |
| | | I _F = 0 mA, V _O = V _{CC} = 15V, T _A = 25°C | | .001 | 1 | |
| | | I _F = 0mA, V _O = V _{CC} = 15V | | | 50 | |
| I _{CCL} | Logic Low Supply Current | I _F = 16mA, V _O = Open, V _{CC} = 15V | | 100 | 200 | μA |
| I _{CCH} | Logic high supply current | I _F = 0 mA, V _O = Open, V _{CC} = 15V, T _A = 25°C | | 0.05 | 1 | μA |
| | | I _F = 0mA, V _O = Open, V _{CC} = 15V | | | 2 | |

Transfer Characteristics

| Symbol | Parameter | Test Conditions | Min. | Typ.* | Max | Unit | |
|-----------------|---------------------------------------|--|---|-------|-----|------|---|
| COUPLED | | | | | | | |
| CTR | Current Transfer Ratio ⁽¹⁾ | I _F = 16mA, V _{CC} = 4.5V | T _A = 25°C V _{OL} =0.4V | 20 | | 50 | % |
| | | | V _{OL} =0.5V | 15 | | | |
| V _{OL} | Logic LOW Output Voltage | I _F = 16mA, I _O = 3mA, V _{CC} = 4.5V, T _A = 25°C | | | 0.4 | V | |
| | | I _F = 16mA, I _O = 2.4mA, V _{CC} = 4.5 V | | | 0.5 | | |

Switching Characteristics (V_{CC} = 5V)

| Symbol | Parameter | Test Conditions | Device | Min. | Typ.* | Max. | Unit |
|------------------|--|--|---------|------|-------|------|-------|
| T _{PHL} | Propagation Delay Time to Logic LOW | R _L = 1.9kΩ, I _F = 16mA, T _A = 25°C ⁽²⁾ (Fig. 9) | | | 0.40 | 0.8 | μs |
| | | R _L = 1.9kΩ, I _F = 16mA ⁽²⁾ (Fig. 9) | | | | 1.0 | |
| T _{PLH} | Propagation Delay Time to Logic HIGH | R _L = 1.9kΩ, I _F = 16mA, T _A = 25°C ⁽²⁾ (Fig. 9) | | | 0.35 | 0.8 | μs |
| | | R _L = 1.9kΩ, I _F = 16mA ⁽²⁾ (Fig. 9) | | | | 1.0 | |
| CM _H | Common Mode Transient Immunity at Logic HIGH | I _F = 0mA, V _{CM} = 10V _{P-P} , R _L = 1.9kΩ, T _A = 25°C ⁽³⁾ (Fig. 10) | FODM452 | 5 | 15 | | KV/μs |
| | | I _F = 0mA, V _{CM} = 1500V _{P-P} , R _L = 1.9kΩ, T _A = 25°C ⁽³⁾ (Fig. 10) | FODM453 | 15 | 40 | | KV/μs |
| CM _L | Common Mode Transient Immunity at Logic LOW | I _F = 16mA, V _{CM} = 10V _{P-P} , R _L = 1.9kΩ, T _A = 25°C ⁽³⁾ (Fig. 10) | FODM452 | 5 | 15 | | KV/μs |
| | | I _F = 16mA, V _{CM} = 1500V _{P-P} , R _L = 1.9kΩ, T _A = 25°C ⁽³⁾ (Fig. 10) | FODM453 | 15 | 40 | | KV/μs |
| BW | Bandwidth | R _L = 100Ω | | | 3 | | MHz |

Isolation Characteristics

| Symbol | Characteristics | Test Conditions | Min. | Typ.* | Max. | Unit |
|------------------|-----------------------------------|--|------|-------|------|------------------|
| V _{ISO} | Withstand Insulation Test Voltage | RH ≤ 50%, T _A = 25°C, t = 1 min. ⁽⁴⁾ | 3750 | | | V _{RMS} |
| C _{I-O} | Capacitance (Input to Output) | f = 1MHz ⁽⁴⁾ | | 0.2 | | pF |

*All Typicals at T_A = 25°C

Notes:

1. Current Transfer Ratio is defined as a ratio of output collector current, I_O , to the forward LED input current, I_F , times 100%.
2. The 1.9k Ω load represents 1 TTL unit load of 1.6mA and 5.6k Ω pull-up resistor.
3. Common mode transient immunity in logic high level is the maximum tolerable (positive) dV_{cm}/dt on the leading edge of the common mode pulse signal V_{CM} , to assure that the output will remain in a logic high state (i.e., $V_O > 2.0V$). Common mode transient immunity in logic low level is the maximum tolerable (negative) dV_{cm}/dt on the trailing edge of the common mode pulse signal, V_{CM} , to assure that the output will remain in a logic low state (i.e., $V_O < 0.8V$).
4. Device is considered a two terminal device: Pins 1, and 3 are shorted together and Pins 4, 5, and 6 are shorted together.

Typical Performance Curves

Fig. 1 Input Forward Current vs Forward Voltage

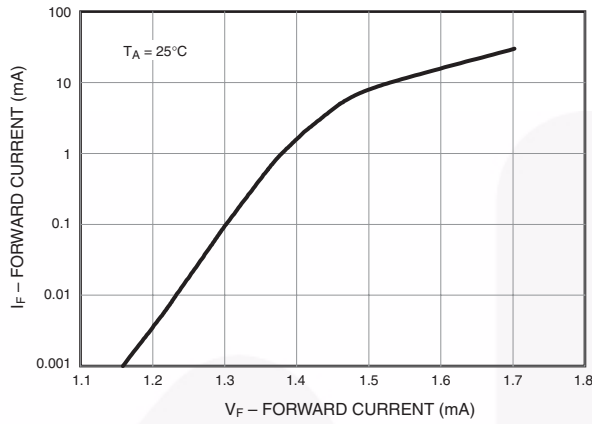

Fig. 2 Normalized Current Transfer Ratio vs. Input Current

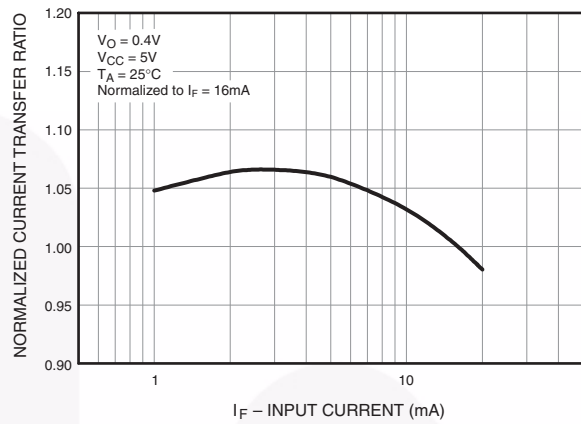

Fig. 3 Normalized Current Transfer Ratio vs. Ambient Temperature

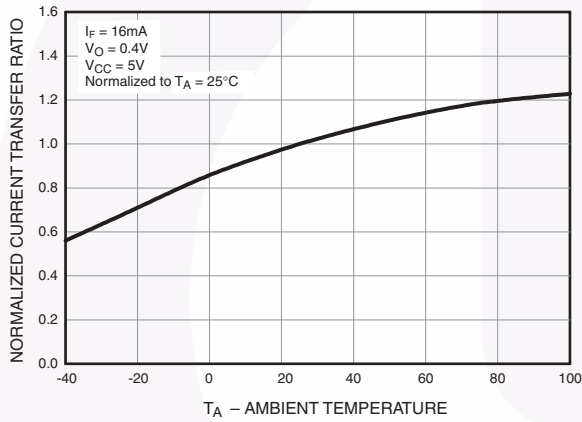

Fig. 4 Logic High Output Current vs. Ambient Temperature

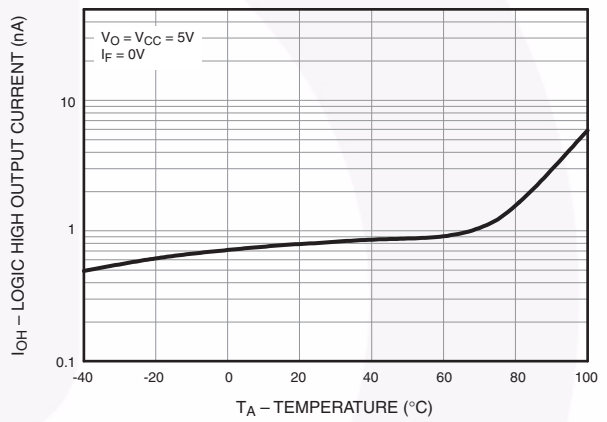

Fig. 5 DC and Pulsed Transfer Characteristics

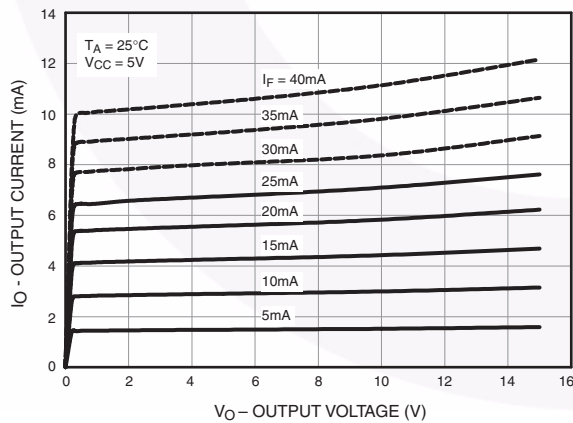
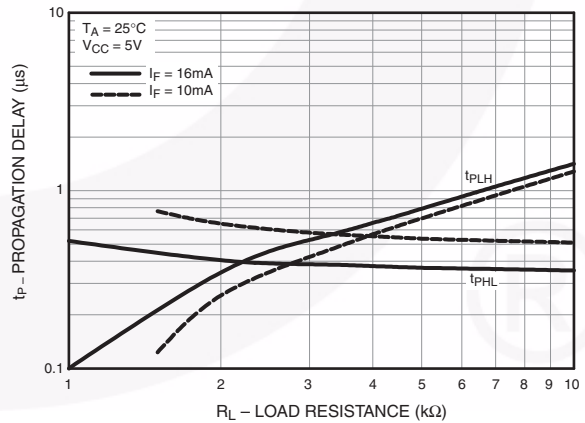

Fig. 6 Propagation Delay vs. Load Resistance



Typical Performance Curves (Continued)

Fig. 7 Propagation Delay vs. Ambient Temperature

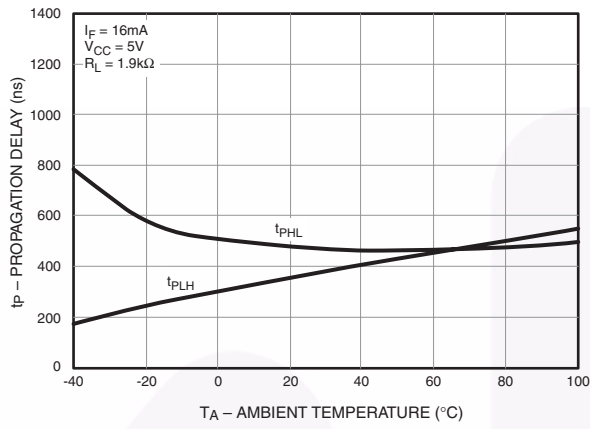
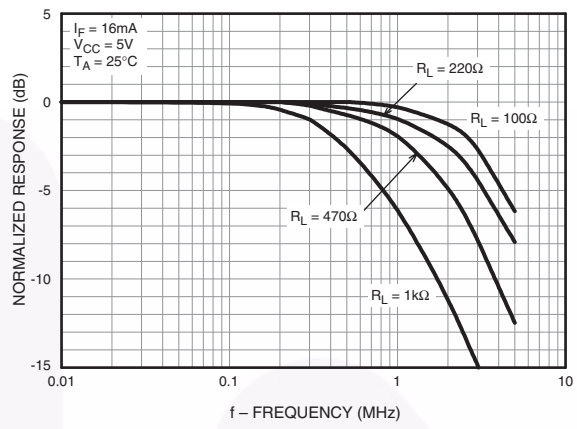

Fig. 8 Frequency Response



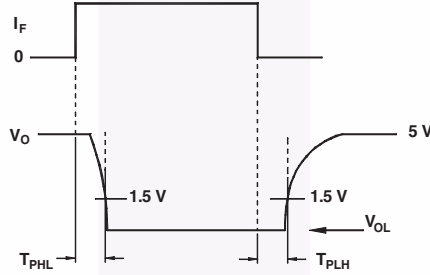
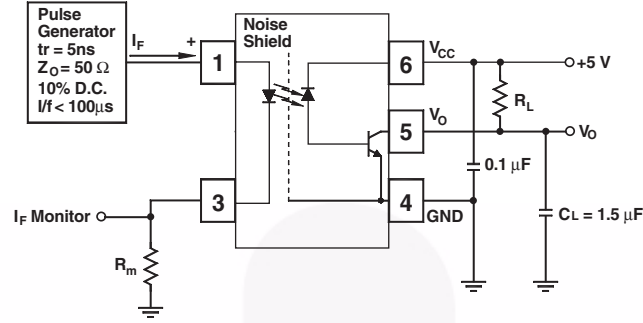

Fig. 9 Switching Time Test Circuit

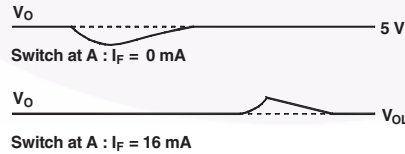
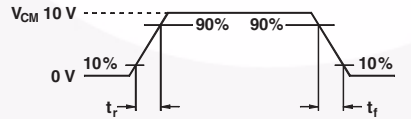
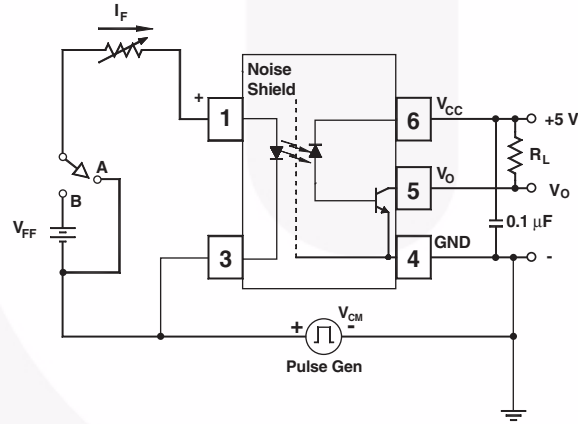
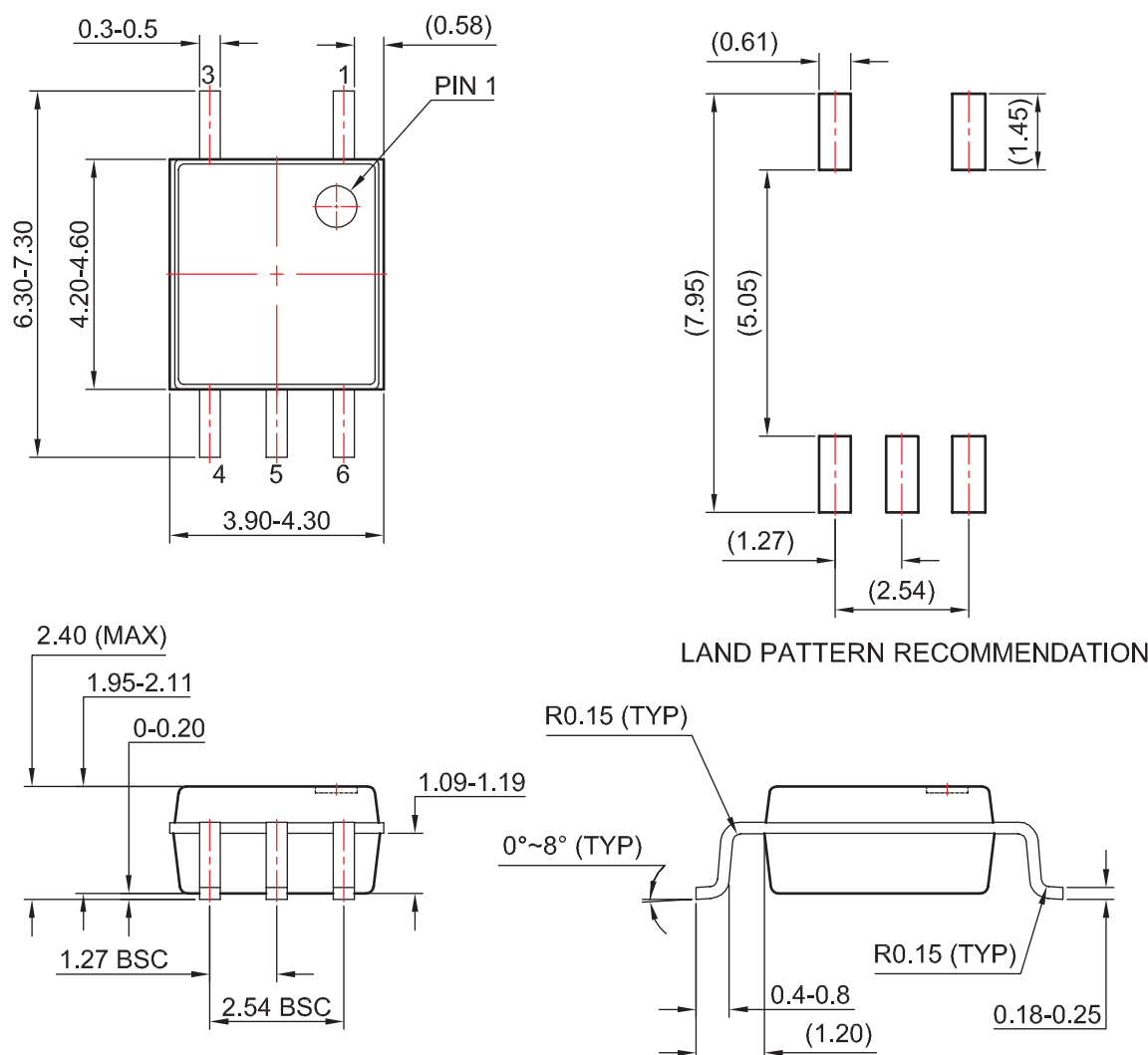

Fig. 10 Common Mode Immunity Test Circuit

Package Dimensions



Notes:

1. No standard applies to this package.
2. All dimensions are in millimeters.
3. Dimensions are exclusive of burrs, mold flash, and tie bar extrusion.
4. Drawings filename and revision: MKT-MFP05A.

Package drawings are provided as a service to customers considering Fairchild components. Drawings may change in any manner without notice. Please note the revision and/or date on the drawing and contact a Fairchild Semiconductor representative to verify or obtain the most recent revision. Package specifications do not expand the terms of Fairchild's worldwide terms and conditions, specifically the warranty therein, which covers Fairchild products.

Always visit Fairchild Semiconductor's online packaging area for the most recent package drawings:

<http://www.fairchildsemi.com/packaging/>

Footprint Drawing for PCB Layout

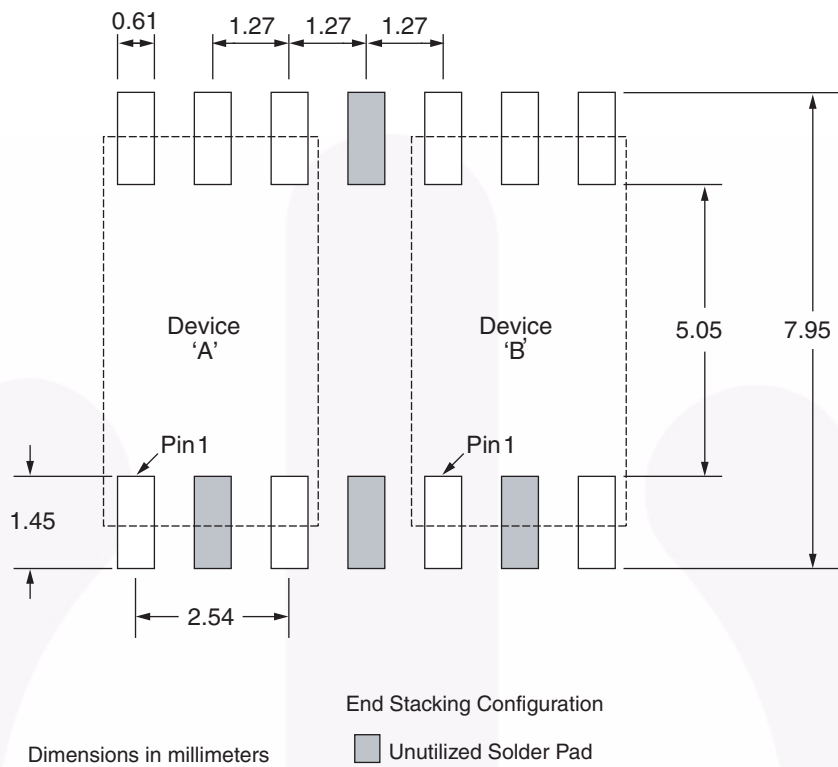

Tape and Reel Dimensions

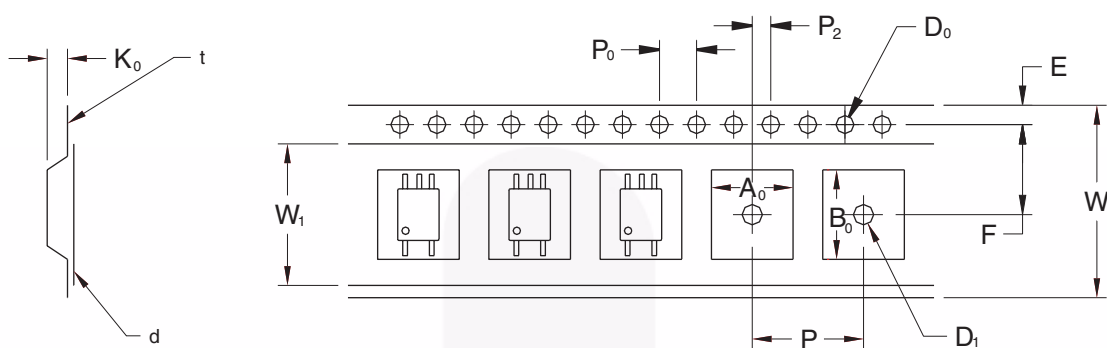

| | | 2.54 Pitch |
|---------------------------------|----------------|-------------------|
| Description | Symbol | Dimensions (mm) |
| Tape Width | W | 12.00 +0.30/-0.10 |
| Tape Thickness | t | 0.30 ±0.05 |
| Sprocket Hole Pitch | P ₀ | 4.00 ±0.10 |
| Sprocket Hole Diameter | D ₀ | 1.50 +0.10/-0.0 |
| Sprocket Hole Location | E | 1.75 ±0.10 |
| Pocket Location | F | 5.50 ±0.10 |
| | P ₂ | 2.00 ±0.10 |
| Pocket Pitch | P | 8.00 ±0.10 |
| Pocket Dimension | A ₀ | 4.40 ±0.10 |
| | B ₀ | 7.30 ±0.10 |
| | K ₀ | 2.30 ±0.10 |
| Pocket Hole Diameter | D ₁ | 1.50 Min. |
| Cover Tape Width | W ₁ | 9.20 |
| Cover Tape Thickness | d | 0.065 ±0.010 |
| Max. Component Rotation or Tilt | | 10° Max. |
| Devices Per Reel | | 2500 |
| Reel Diameter | | 330mm (13") |

Ordering Information

| Option | Order Entry Identifier (example) | Description |
|--------|-------------------------------------|---|
| R2 | FODM452R2 | Tape and Reel (2500 per reel) |
| V | FODM452V | IEC60747-5-2 |
| R2V | FODM452R2V | IEC60747-5-2, Tape and Reel (2500 per reel) |

Marking Information

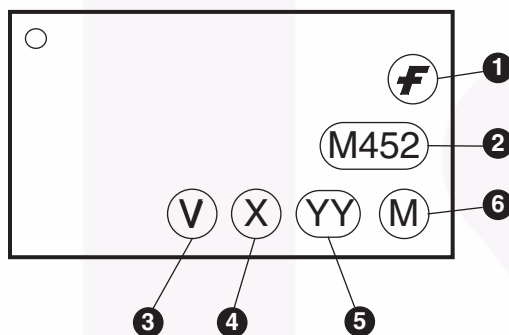

| Definitions | |
|-------------|---|
| 1 | Fairchild logo |
| 2 | Device number |
| 3 | IEC60747-5-2 mark (Note: Only appears on parts ordered with VDE option – See order entry table) |
| 4 | One digit year code, e.g., '7' |
| 5 | Two digit work week ranging from '01' to '53' |
| 6 | Assembly package code |

Reflow Profile

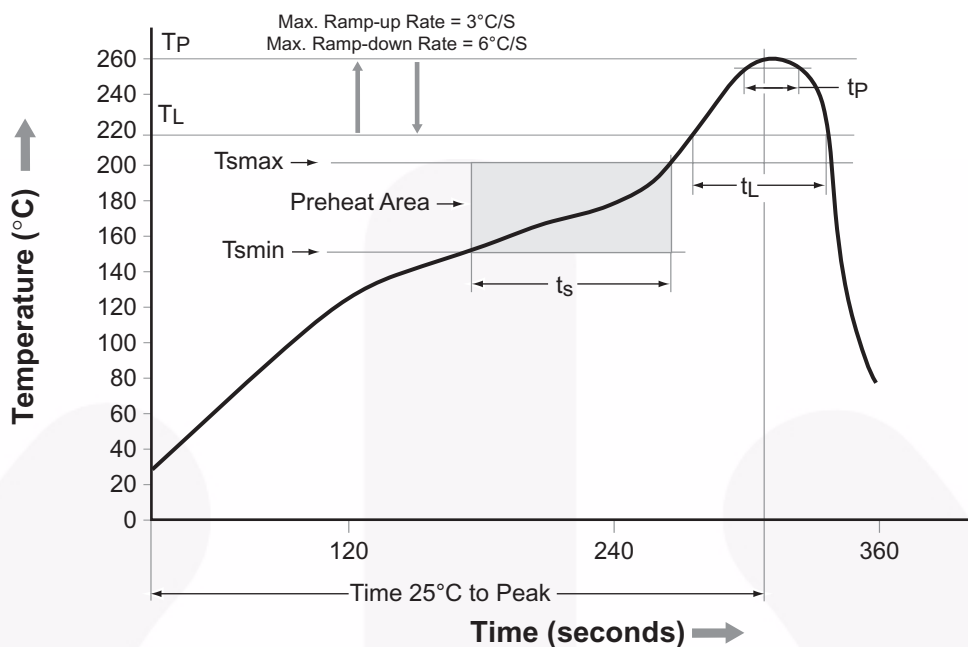

| Profile Feature | Pb-Free Assembly Profile |
|---|--------------------------|
| Temperature Min. (T _{smín}) | 150°C |
| Temperature Max. (T _{smáx}) | 200°C |
| Time (t _s) from (T _{smín} to T _{smáx}) | 60–120 seconds |
| Ramp-up Rate (t _L to t _p) | 3°C/second max. |
| Liquidous Temperature (T _L) | 217°C |
| Time (t _L) Maintained Above (T _L) | 60–150 seconds |
| Peak Body Package Temperature | 260°C +0°C / -5°C |
| Time (t _p) within 5°C of 260°C | 30 seconds |
| Ramp-down Rate (T _p to T _L) | 6°C/second max. |
| Time 25°C to Peak Temperature | 8 minutes max. |





TRADEMARKS

The following includes registered and unregistered trademarks and service marks, owned by Fairchild Semiconductor and/or its global subsidiaries, and is not intended to be an exhaustive list of all such trademarks.

AccuPower™
 AttitudeEngine™
 Awinda®
 AX-CAP®*
 BitSiC™
 Build it Now™
 CorePLUS™
 CorePOWER™
 CROSSVOL™
 CTL™
 Current Transfer Logic™
 DEUXPEED®
 Dual Cool™
 EcoSPARK®
 EfficientMax™
 ESBC™
 F™
 Fairchild®
 Fairchild Semiconductor®
 FACT Quiet Series™
 FACT®
 FastvCore™
 FETBench™
 FPS™

F-PFS™
 FRFET®
 Global Power Resource™
 GreenBridge™
 Green FPS™
 Green FPS™ e-Series™
 Gmax™
 GTO™
 IntelliMAX™
 ISOPLANAR™
 Making Small Speakers Sound Louder and Better™
 MegaBuck™
 MICROCOUPLER™
 MicroFET™
 MicroPak™
 MicroPak2™
 MillerDrive™
 MotionMax™
 MotionGrid®
 MTi®
 MTx®
 MVN®
 mWSaver®
 OptoHiT™
 OPTOLOGIC®

OPTOPLANAR®
®
 Power Supply WebDesigner™
 PowerTrench®
 PowerXS™
 Programmable Active Droop™
 QFET®
 QS™
 Quiet Series™
 RapidConfigure™
™
 Saving our world, 1mW/W/kW at a time™
 SignalWise™
 SmartMax™
 SMART START™
 Solutions for Your Success™
 SPM®
 STEALTH™
 SuperFET®
 SuperSOT™-3
 SuperSOT™-6
 SuperSOT™-8
 SupreMOS®
 SyncFET™
 Sync-Lock™

 SYSTEM GENERAL®
 TinyBoost®
 TinyBuck®
 TinyCalc™
 TinyLogic®
 TINYOPTO™
 TinyPower™
 TinyPWM™
 TinyWire™
 TranSiC™
 TriFault Detect™
 TRUECURRENT®*
 μSerDes™
 SerDes™
 UHC®
 Ultra FRFET™
 UniFET™
 VCX™
 VisualMax™
 VoltagePlus™
 XS™
 Xsens™
 仙童™

* Trademarks of System General Corporation, used under license by Fairchild Semiconductor.

DISCLAIMER

FAIRCHILD SEMICONDUCTOR RESERVES THE RIGHT TO MAKE CHANGES WITHOUT FURTHER NOTICE TO ANY PRODUCTS HEREIN TO IMPROVE RELIABILITY, FUNCTION, OR DESIGN. TO OBTAIN THE LATEST, MOST UP-TO-DATE DATASHEET AND PRODUCT INFORMATION, VISIT OUR WEBSITE AT [HTTP://WWW.FAIRCHILDSEMI.COM](http://www.fairchildsemi.com). FAIRCHILD DOES NOT ASSUME ANY LIABILITY ARISING OUT OF THE APPLICATION OR USE OF ANY PRODUCT OR CIRCUIT DESCRIBED HEREIN; NEITHER DOES IT CONVEY ANY LICENSE UNDER ITS PATENT RIGHTS, NOR THE RIGHTS OF OTHERS. THESE SPECIFICATIONS DO NOT EXPAND THE TERMS OF FAIRCHILD'S WORLDWIDE TERMS AND CONDITIONS, SPECIFICALLY THE WARRANTY THEREIN, WHICH COVERS THESE PRODUCTS.

AUTHORIZED USE

Unless otherwise specified in this data sheet, this product is a standard commercial product and is not intended for use in applications that require extraordinary levels of quality and reliability. This product may not be used in the following applications, unless specifically approved in writing by a Fairchild officer: (1) automotive or other transportation, (2) military/aerospace, (3) any safety critical application – including life critical medical equipment – where the failure of the Fairchild product reasonably would be expected to result in personal injury, death or property damage. Customer's use of this product is subject to agreement of this Authorized Use policy. In the event of an unauthorized use of Fairchild's product, Fairchild accepts no liability in the event of product failure. In other respects, this product shall be subject to Fairchild's Worldwide Terms and Conditions of Sale, unless a separate agreement has been signed by both Parties.

ANTI-COUNTERFEITING POLICY

Fairchild Semiconductor Corporation's Anti-Counterfeiting Policy. Fairchild's Anti-Counterfeiting Policy is also stated on our external website, www.fairchildsemi.com, under Terms of Use

Counterfeiting of semiconductor parts is a growing problem in the industry. All manufacturers of semiconductor products are experiencing counterfeiting of their parts. Customers who inadvertently purchase counterfeit parts experience many problems such as loss of brand reputation, substandard performance, failed applications, and increased cost of production and manufacturing delays. Fairchild is taking strong measures to protect ourselves and our customers from the proliferation of counterfeit parts. Fairchild strongly encourages customers to purchase Fairchild parts either directly from Fairchild or from Authorized Fairchild Distributors who are listed by country on our web page cited above. Products customers buy either from Fairchild directly or from Authorized Fairchild Distributors are genuine parts, have full traceability, meet Fairchild's quality standards for handling and storage and provide access to Fairchild's full range of up-to-date technical and product information. Fairchild and our Authorized Distributors will stand behind all warranties and will appropriately address any warranty issues that may arise. Fairchild will not provide any warranty coverage or other assistance for parts bought from Unauthorized Sources. Fairchild is committed to combat this global problem and encourage our customers to do their part in stopping this practice by buying direct or from authorized distributors.

PRODUCT STATUS DEFINITIONS

Definition of Terms

| Datasheet Identification | Product Status | Definition |
|--------------------------|-----------------------|---|
| Advance Information | Formative / In Design | Datasheet contains the design specifications for product development. Specifications may change in any manner without notice. |
| Preliminary | First Production | Datasheet contains preliminary data; supplementary data will be published at a later date. Fairchild Semiconductor reserves the right to make changes at any time without notice to improve design. |
| No Identification Needed | Full Production | Datasheet contains final specifications. Fairchild Semiconductor reserves the right to make changes at any time without notice to improve the design. |
| Obsolete | Not In Production | Datasheet contains specifications on a product that is discontinued by Fairchild Semiconductor. The datasheet is for reference information only. |

Rev. 176

ON Semiconductor and  are trademarks of Semiconductor Components Industries, LLC dba ON Semiconductor or its subsidiaries in the United States and/or other countries. ON Semiconductor owns the rights to a number of patents, trademarks, copyrights, trade secrets, and other intellectual property. A listing of ON Semiconductor's product/patent coverage may be accessed at www.onsemi.com/site/pdf/Patent-Marking.pdf. ON Semiconductor reserves the right to make changes without further notice to any products herein. ON Semiconductor makes no warranty, representation or guarantee regarding the suitability of its products for any particular purpose, nor does ON Semiconductor assume any liability arising out of the application or use of any product or circuit, and specifically disclaims any and all liability, including without limitation special, consequential or incidental damages. Buyer is responsible for its products and applications using ON Semiconductor products, including compliance with all laws, regulations and safety requirements or standards, regardless of any support or applications information provided by ON Semiconductor. "Typical" parameters which may be provided in ON Semiconductor data sheets and/or specifications can and do vary in different applications and actual performance may vary over time. All operating parameters, including "Typicals" must be validated for each customer application by customer's technical experts. ON Semiconductor does not convey any license under its patent rights nor the rights of others. ON Semiconductor products are not designed, intended, or authorized for use as a critical component in life support systems or any FDA Class 3 medical devices or medical devices with a same or similar classification in a foreign jurisdiction or any devices intended for implantation in the human body. Should Buyer purchase or use ON Semiconductor products for any such unintended or unauthorized application, Buyer shall indemnify and hold ON Semiconductor and its officers, employees, subsidiaries, affiliates, and distributors harmless against all claims, costs, damages, and expenses, and reasonable attorney fees arising out of, directly or indirectly, any claim of personal injury or death associated with such unintended or unauthorized use, even if such claim alleges that ON Semiconductor was negligent regarding the design or manufacture of the part. ON Semiconductor is an Equal Opportunity/Affirmative Action Employer. This literature is subject to all applicable copyright laws and is not for resale in any manner.

PUBLICATION ORDERING INFORMATION

LITERATURE FULFILLMENT:

Literature Distribution Center for ON Semiconductor
19521 E. 32nd Pkwy, Aurora, Colorado 80011 USA
Phone: 303-675-2175 or 800-344-3860 Toll Free USA/Canada
Fax: 303-675-2176 or 800-344-3867 Toll Free USA/Canada
Email: orderlit@onsemi.com

N. American Technical Support: 800-282-9855 Toll Free
USA/Canada
Europe, Middle East and Africa Technical Support:
Phone: 421 33 790 2910
Japan Customer Focus Center
Phone: 81-3-5817-1050

ON Semiconductor Website: www.onsemi.com
Order Literature: <http://www.onsemi.com/orderlit>
For additional information, please contact your local
Sales Representative