



Chipsmall Limited consists of a professional team with an average of over 10 year of expertise in the distribution of electronic components. Based in Hongkong, we have already established firm and mutual-benefit business relationships with customers from,Europe,America and south Asia,supplying obsolete and hard-to-find components to meet their specific needs.

With the principle of “Quality Parts,Customers Priority,Honest Operation,and Considerate Service”,our business mainly focus on the distribution of electronic components. Line cards we deal with include Microchip,ALPS,ROHM,Xilinx,Pulse,ON,Everlight and Freescale. Main products comprise IC,Modules,Potentiometer,IC Socket,Relay,Connector.Our parts cover such applications as commercial,industrial, and automotives areas.

We are looking forward to setting up business relationship with you and hope to provide you with the best service and solution. Let us make a better world for our industry!



## Contact us

Tel: +86-755-8981 8866 Fax: +86-755-8427 6832

Email & Skype: info@chipsmall.com Web: www.chipsmall.com

Address: A1208, Overseas Decoration Building, #122 Zhenhua RD., Futian, Shenzhen, China



REVISION D

REVISION

C	JW	A Wroten
1/10/2017	ECN-292694	
PART CALLOUT: ADD -03, -04, -05, -06 TO END 1. ADD *LEAVE BLANK FOR END 1 OPTIONS -03, -04, -05, -06* TO END 2. LENGTH, FIBERS, AND CONSTRUCTION CALL OUTS, ADD FIG 3; ADD SHT 3; SHT 4; ADD FOPC-03, FOPC-04, FOPC-05, FOPC-06 TO TABLE 3;		
D	AG	A Wroten
5/31/2018	ECN-328992	
PART CALLOUT: ADD -02, -03 TO CONSTRUCTION; SHT 4, TABLE 3; ADD *FOPC-02-02-003-24-02*, *FOPC-02-02-010-24-02*, *FOPC-02-02-100-24-02*, *FOPC-02-02-003-24-03*, *FOPC-02-02-010-24-03* & *FOPC-02-02-100-24-03*		

FOPC-XX-XX-XXX-XX-XX

- END 1**  
MTP MALE: -01  
MTP FEMALE: -02  
QSFP LOOPBACK MALE: -03  
QSFP LOOPBACK FEMALE: -04  
CXP LOOPBACK MALE: -05  
CXP LOOPBACK FEMALE: -06
- END 2\***  
MTP MALE: -01  
MTP FEMALE: -02
- CONSTRUCTION\***  
-01: 3mm ROUND JACKET  
-02: ORANGE SECURE KEY MTP  
-03: BLUE SECURE KEY MTP
- FIBERS\***  
-12  
-24
- LENGTH\***  
-003: 3 METERS  
-010: 10 METERS  
-100: 100 METERS  
(OTHER LENGTHS AVAILABLE AS CUSTOM PART NUMBERS)
- \* LEAVE BLANK FOR END 1 OPTIONS -03, -04, -05, -06

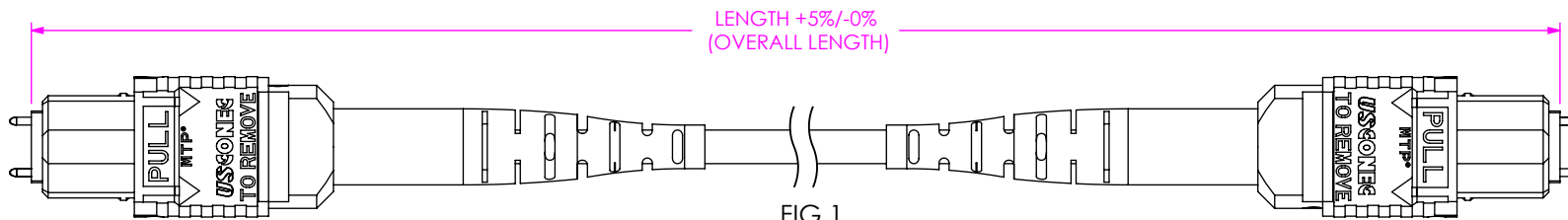

FIG 1  
FOPC-01-01-XXX-12-01 SHOWN

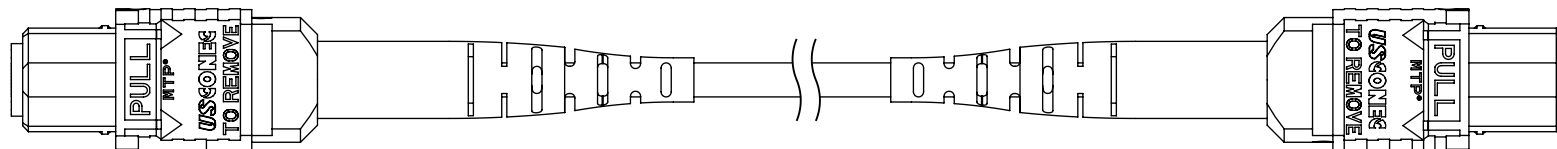

FIG 2  
FOPC-02-02-XXX-24-01 SHOWN

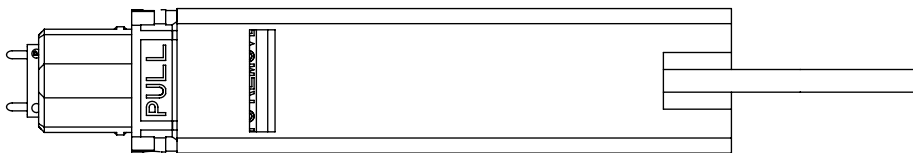

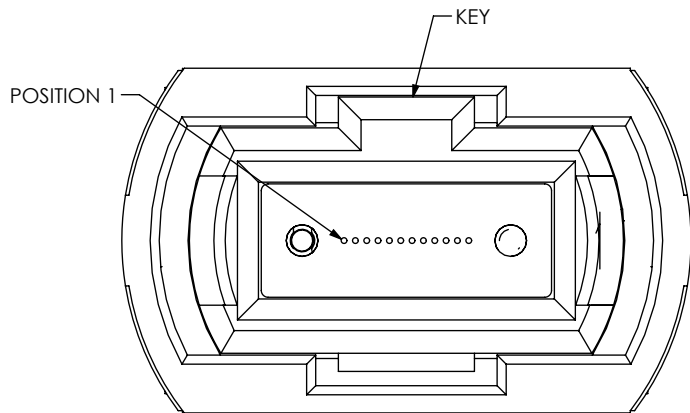

FIG3  
FOPC-03 SHOWN

DO NOT SCALE FROM THIS PRINT

<p>TOLERANCES DO NOT APPLY TO REFERENCE DIMENSIONS. UNLESS OTHERWISE SPECIFIED, DIMENSIONS ARE IN INCHES. TOLERANCES ARE:</p> <p>DECIMALS    ANGLES  .XX: ±.01 [.3]    2°  .XXX: ±.005 [.13]  .XXXX: ±.0020 [.051]</p>	<p><b>PROPRIETARY NOTE</b></p> <p>THIS DOCUMENT CONTAINS CONFIDENTIAL AND PROPRIETARY INFORMATION AND ALL DESIGN, MANUFACTURING, REPRODUCTION, USE, PATENT RIGHTS AND SALES RIGHTS ARE EXPRESSLY RESERVED BY SAMTEC, INC. THIS DOCUMENT SHALL NOT BE DISCLOSED, IN WHOLE OR PART, TO ANY UNAUTHORIZED PERSON OR ENTITY NOR REPRODUCED, TRANSFERRED OR INCORPORATED IN ANY OTHER PROJECT IN ANY MANNER WITHOUT THE EXPRESS WRITTEN CONSENT OF SAMTEC, INC.</p>	 <p>520 PARK EAST BLVD, NEW ALBANY, IN 47150  PHONE: 812-944-6733    FAX: 812-948-5047  e-Mail: info@SAMTEC.com    code 55322</p>



12 FIBER CONNECTOR

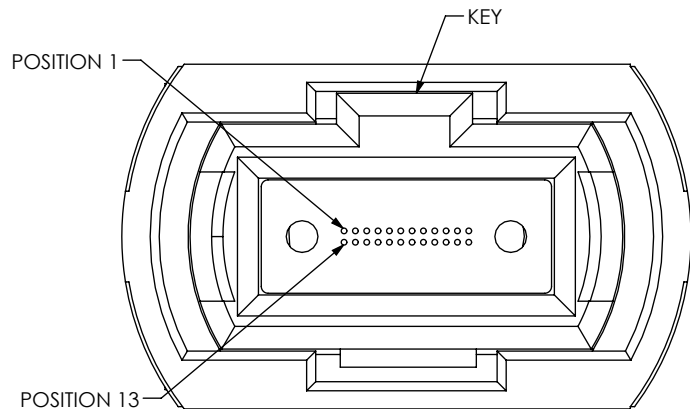

24 FIBER CONNECTOR

SIDE A POSITION	FIBER COLOR	SIDE B POSITION
1	BLUE	12
2	ORANGE	11
3	GREEN	10
4	BROWN	9
5	SLATE	8
6	WHITE	7
7	RED	6
8	BLACK	5
9	YELLOW	4
10	VIOLET	3
11	ROSE	2
12	AQUA	1

SIDE A POSITION	FIBER COLOR	SIDE B POSITION	
1	BLUE	13	
2	ORANGE	14	
3	GREEN	15	
4	BROWN	16	
5	SLATE	17	
6	WHITE	18	
7	RED	19	
8	BLACK	20	
9	YELLOW	21	
10	VIOLET	22	
11	ROSE	23	
12	AQUA	24	
13	BLUE	+	1
14	ORANGE	+	2
15	GREEN	+	3
16	BROWN	+	4
17	SLATE	+	5
18	WHITE	+	6
19	RED	+	7
20	BLACK	+	8
21	YELLOW	+	9
22	VIOLET	+	10
23	ROSE	+	11
24	AQUA	+	12

- NOTES:
1. ALL PATCH CABLES BUILT WITH 12 FIBERS ARE TYPE B POLARITY (SEE TABLE 1)
  2. ALL PATCH CABLES BUILT WITH 24 FIBERS ARE TYPE C POLARITY (SEE TABLE 2)
  3. EMAIL OPTICS@SAMTEC.COM FOR SPECIFIC APPLICATION INFORMATION

**PROPRIETARY NOTE**  
 THIS DOCUMENT CONTAINS CONFIDENTIAL AND PROPRIETARY INFORMATION AND ALL DESIGN, MANUFACTURING, REPRODUCTION, USE, PATENT RIGHTS AND SALES RIGHTS ARE EXPRESSLY RESERVED BY SAMTEC, INC. THIS DOCUMENT SHALL NOT BE DISCLOSED, IN WHOLE OR PART, TO ANY UNAUTHORIZED PERSON OR ENTITY NOR REPRODUCED, TRANSFERRED OR INCORPORATED IN ANY OTHER PROJECT IN ANY MANNER WITHOUT THE EXPRESS WRITTEN CONSENT OF SAMTEC, INC.



520 PARK EAST BLVD, NEW ALBANY, IN 47150  
 PHONE: 812-944-6733 FAX: 812-948-5047  
 e-Mail info@SAMTEC.com code 55322





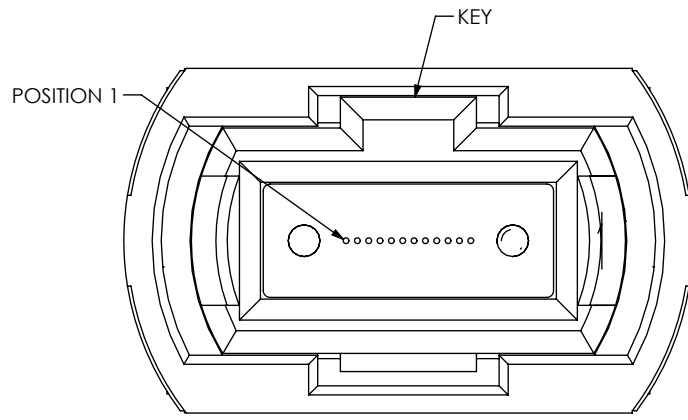

DESCRIPTION: FIBER OPTIC PATCH CABLE

DWG. NO. FOPC-XX-XX-XXX-XX-XX

BY: JEAN W. 02/05/2015 SHEET 2 OF 4







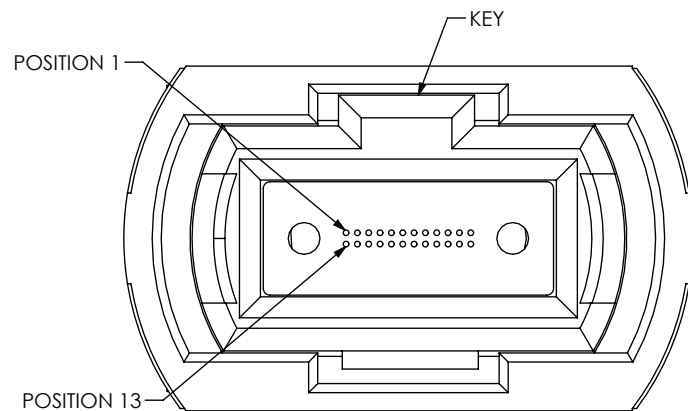







QSFP LOOPBACK

TABLE 5: QSFP LOOPBACK COLOUR CODING			
		FIBER COLOR	
1	12	BLUE	
2	11	ORANGE	
3	10	GREEN	
4	9	BROWN	
5	8	SLATE	
6	7	WHITE	



CXP / CFP LOOPBACK

TABLE 6: CXP/CFP LOOPBACK COLOUR CODING			
		FIBER COLOR	
1	13	BLUE	
2	14	ORANGE	
3	15	GREEN	
4	16	BROWN	
5	17	SLATE	
6	18	WHITE	
7	19	RED	
8	20	BLACK	
9	21	YELLOW	
10	22	VIOLET	
11	23	ROSE	
12	24	AQUA	

NOTES:

1. ALL PATCH CABLES BUILT WITH 12 FIBERS ARE TYPE B POLARITY (SEE TABLE 1)
2. ALL PATCH CABLES BUILT WITH 24 FIBERS ARE TYPE C POLARITY (SEE TABLE 2)
3. EMAIL OPTICS@SAMTEC.COM FOR SPECIFIC APPLICATION INFORMATION

**PROPRIETARY NOTE**  
 THIS DOCUMENT CONTAINS CONFIDENTIAL AND PROPRIETARY INFORMATION AND ALL DESIGN, MANUFACTURING, REPRODUCTION, USE, PATENT RIGHTS AND SALES RIGHTS ARE EXPRESSLY RESERVED BY SAMTEC, INC. THIS DOCUMENT SHALL NOT BE DISCLOSED, IN WHOLE OR PART, TO ANY UNAUTHORIZED PERSON OR ENTITY NOR REPRODUCED, TRANSFERRED OR INCORPORATED IN ANY OTHER PROJECT IN ANY MANNER WITHOUT THE EXPRESS WRITTEN CONSENT OF SAMTEC, INC.



520 PARK EAST BLVD, NEW ALBANY, IN 47150  
 PHONE: 812-944-6733 FAX: 812-948-5047  
 e-Mail info@SAMTEC.com code 55322

DESCRIPTION: FIBER OPTIC PATCH CABLE

DWG. NO. FOPC-XX-XX-XXX-XX-XX

BY: JEAN W. 02/05/2015 SHEET 3 OF 4

PACKAGING VIEW

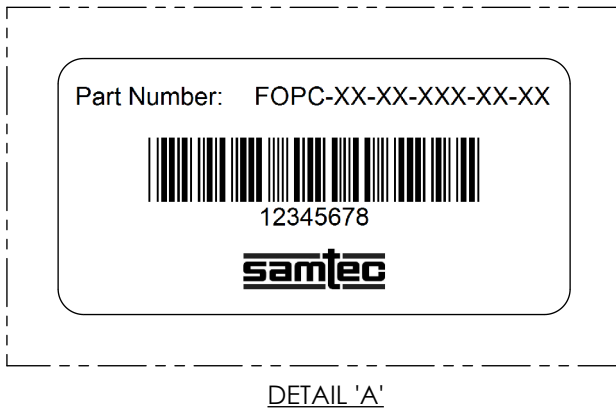
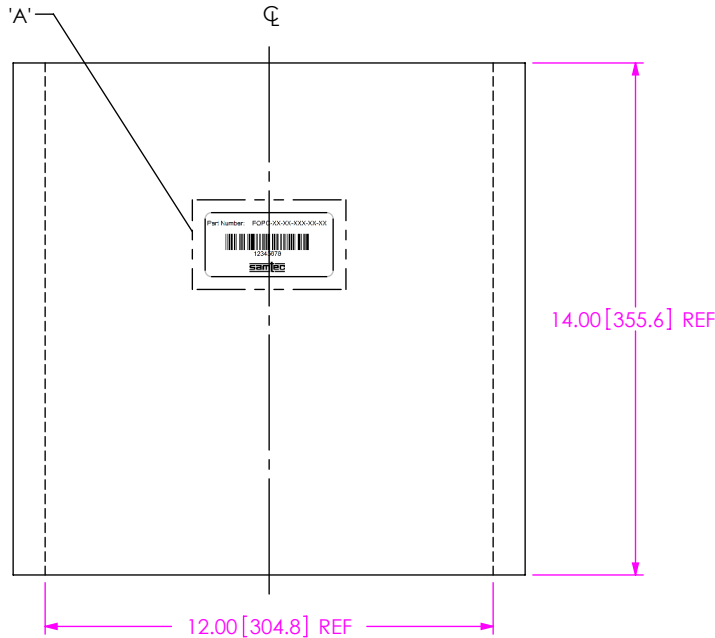

FIBER CABLE SPECIFICATIONS	
JACKET COLOR	AQUA
JACKET UL RATING	UL-910 OFNP
MODE	MULTIMODE
INSERTION LOSS	< 0.75 dB
RETURN LOSS	> 20 dB
OPERATING WAVELENGTH	850 nm - 1310 nm
CORE/CLADDING/BUFFER	50 μm / 125 μm / 250 μm

TABLE 3: FIBER OPTIC PATCH CABLE	
PART NUMBER	BOM ITEM
FOPC-01-01-003-12-01	CCS-187300-01-FC
FOPC-01-01-010-12-01	CCS-187300-02-FC
FOPC-01-01-100-12-01	CCS-187300-03-FC
FOPC-01-01-003-24-01	FOP-06-06-A-24-01-003.0
FOPC-01-01-010-24-01	FOP-06-06-A-24-01-010.0
FOPC-01-01-100-24-01	FOP-06-06-A-24-01-100.0
FOPC-01-02-003-12-01	CCS-185419-01-FC
FOPC-01-02-005-12-01	CCS-185419-04-FC
FOPC-01-02-010-12-01	CCS-185419-02-FC
FOPC-01-02-020-12-01	CCS-185419-05-FC
FOPC-01-02-100-12-01	CCS-185419-03-FC
FOPC-01-02-003-24-01	FOP-06-07-A-24-01-003.0
FOPC-01-02-010-24-01	FOP-06-07-A-24-01-010.0
FOPC-01-02-100-24-01	FOP-06-07-A-24-01-100.0
FOPC-02-02-003-12-01	CCS-187303-01-FC
FOPC-02-02-010-12-01	CCS-187303-02-FC
FOPC-02-02-100-12-01	CCS-187303-03-FC
FOPC-02-02-003-24-01	FOP-07-07-A-24-01-003.0
FOPC-02-02-010-24-01	FOP-07-07-A-24-01-010.0
FOPC-02-02-100-24-01	FOP-07-07-A-24-01-100.0
FOPC-02-02-003-24-02	CCS-192313-03-FC
FOPC-02-02-010-24-02	CCS-192313-05-FC
FOPC-02-02-100-24-02	CCS-192313-04-FC
FOPC-02-02-003-24-03	CCS-192314-03-FC
FOPC-02-02-010-24-03	CCS-192314-05-FC
FOPC-02-02-100-24-03	CCS-192314-14-FC
FOPC-03	QSFP-MTP-LOOPBACK-OM3-M
FOPC-04	QSFP-MTP-LOOPBACK-OM3-F
FOPC-05	MTP-24-LOOPBACK-OM3-M
FOPC-06	MTP-24-LOOPBACK-OM3-F

TABLE 4: BOM

ITEM	PART NUMBER	DESCRIPTION	QTY	COST QTY	UOM
1	SEE TABLE 3	FIBER OPTIC PATCH CABLE	1	1	EACH
2	SSBAG-12X14-AS	PACKAGING BAG	1	1	EACH
3	LABEL-4X2	LABEL	1/3000	1/3000	EACH

**PROPRIETARY NOTE**  
 THIS DOCUMENT CONTAINS CONFIDENTIAL AND PROPRIETARY INFORMATION AND ALL DESIGN, MANUFACTURING, REPRODUCTION, USE, PATENT RIGHTS AND SALES RIGHTS ARE EXPRESSLY RESERVED BY SAMTEC, INC. THIS DOCUMENT SHALL NOT BE DISCLOSED, IN WHOLE OR PART, TO ANY UNAUTHORIZED PERSON OR ENTITY NOR REPRODUCED, TRANSFERRED OR INCORPORATED IN ANY OTHER PROJECT IN ANY MANNER WITHOUT THE EXPRESS WRITTEN CONSENT OF SAMTEC, INC.



520 PARK EAST BLVD, NEW ALBANY, IN 47150  
 PHONE: 812-944-6733 FAX: 812-948-5047  
 e-Mail: info@SAMTEC.com code 55322

DESCRIPTION: FIBER OPTIC PATCH CABLE

DWG. NO. FOPC-XX-XX-XXX-XX-XX

BY: JEAN W. 02/05/2015 SHEET 4 OF 4