



Chipsmall Limited consists of a professional team with an average of over 10 year of expertise in the distribution of electronic components. Based in Hongkong, we have already established firm and mutual-benefit business relationships with customers from,Europe,America and south Asia,supplying obsolete and hard-to-find components to meet their specific needs.

With the principle of “Quality Parts,Customers Priority,Honest Operation,and Considerate Service”,our business mainly focus on the distribution of electronic components. Line cards we deal with include Microchip,ALPS,ROHM,Xilinx,Pulse,ON,Everlight and Freescale. Main products comprise IC,Modules,Potentiometer,IC Socket,Relay,Connector.Our parts cover such applications as commercial,industrial, and automotives areas.

We are looking forward to setting up business relationship with you and hope to provide you with the best service and solution. Let us make a better world for our industry!



Contact us

Tel: +86-755-8981 8866 Fax: +86-755-8427 6832

Email & Skype: info@chipsmall.com Web: www.chipsmall.com

Address: A1208, Overseas Decoration Building, #122 Zhenhua RD., Futian, Shenzhen, China



FP1 1 10V

High frequency, high current power inductors



Description

- Vertical design utilizes less board space
- Controlled DCR for sensing circuits
- Inductance Range from 195 nH to 320nH
- Current range from 42 to 70 amps
- 10.7 x 7.5mm and 10.5 x 6.2mm footprint surface mount package in a 9.5mm height
- Ferrite core material
- Halogen free, lead free, RoHS compliant

Applications

- Servers
- Multi-phase and Vcore regulators
- Voltage Regulator Modules (VRMs)
- Desktop VRMs and EVRDs
- Data networking and storage systems
- Point-of-Load modules
- DCR Sensing circuits

Environmental Data

- Storage temperature range (Component): -40°C to +125°C
- Operating temperature range: -40°C to +125°C (ambient + self-temperature rise)
- Solder reflow temperature: J-STD-020D compliant



Product specifications

Part Number ⁷	OCL ¹ (nH) ±10%	FLL ² minimum (nH)	I _{rms} ³ (amps)	I _{sat1} ⁴ (amps)	I _{sat2} ⁵ (amps)	DCR (mΩ) ±5% @ +20°C	K-factor ⁶
V1-10.7 x 7.5 x 9.5mm							
FP1110V1-R20-R	195	140	61	70	58	0.23	278
FP1110V1-R22-R	220	158	61	64	51	0.23	278
FP1110V1-R27-R	270	173	61	55	44	0.23	278
FP1110V1-R32-R	320	230	61	42	34	0.23	278
V2-10.5 x 6.2 x 9.5mm							
FP1110V2-R200-R	200	144	61	65	52	0.18	328

- Open Circuit Inductance (OCL) Test Parameters: 100kHz, 0.1Vrms, 0.0Aac, +25°C
- Full Load Inductance (FLL) Test Parameters: 100kHz, 0.1Vrms, @ I_{sat1}, @ +25°C
- I_{lim}: DC current for an approximate temperature rise of 40°C without core loss. Derating is necessary for AC currents. PCB layout, trace thickness and width, air-flow, and proximity of other heat generating components will affect the temperature rise. It is recommended that the temperature of the part not exceed +125°C under worst case operating conditions verified in the end application.
- I_{sat1}: Peak current for approximately 20% rolloff @ +25°C

- I_{sat}: Peak current for approximately 20% rolloff @ +100°C
- K-factor: Used to determine B_{ps} for core loss (see graph). B_{ps} = K * L * ΔI * 10³.
B_{ps}:(Gauss), K: (K-factor from table), L: (Inductance in nH), ΔI (Peak to peak ripple current in Amps).
- Part Number Definition: FP1110Vx-Rxx(x)-R
FP1110V = Product code
x = DCR indicator
Rxx(x) = Inductance value in uH, R = decimal point
-R suffix = RoHS compliant

Dimensions (mm)

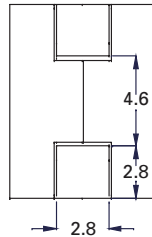
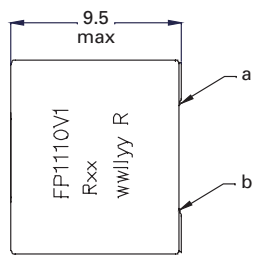
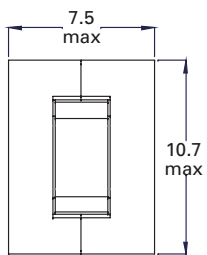

Recommended Pad Layout

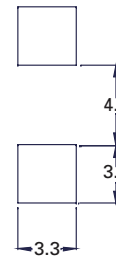

Schematic

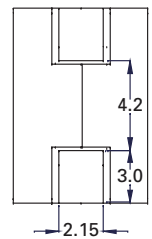
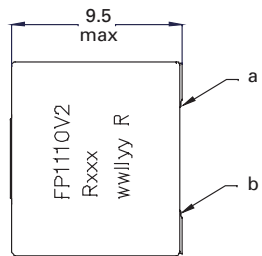
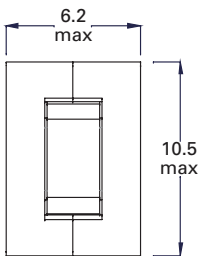
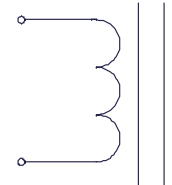

Recommended Pad Layout

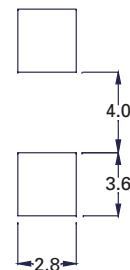

Schematic

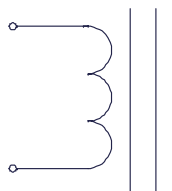

Part marking: FP1110V1 or V2, Rxx(x)=inductance value in μH, R=decimal point
wwlllyy= date code, R=revision level
DCR measured from point "a" to point "b"
Soldering surfaces to be coplanar within 0.10 millimeters
Do not route traces or vias underneath the inductor.

Packaging information (mm)

(Drawing not to scale)

(Supplied in tape and reel packaging, 300 parts per 13" diameter reel)

FP1110V1

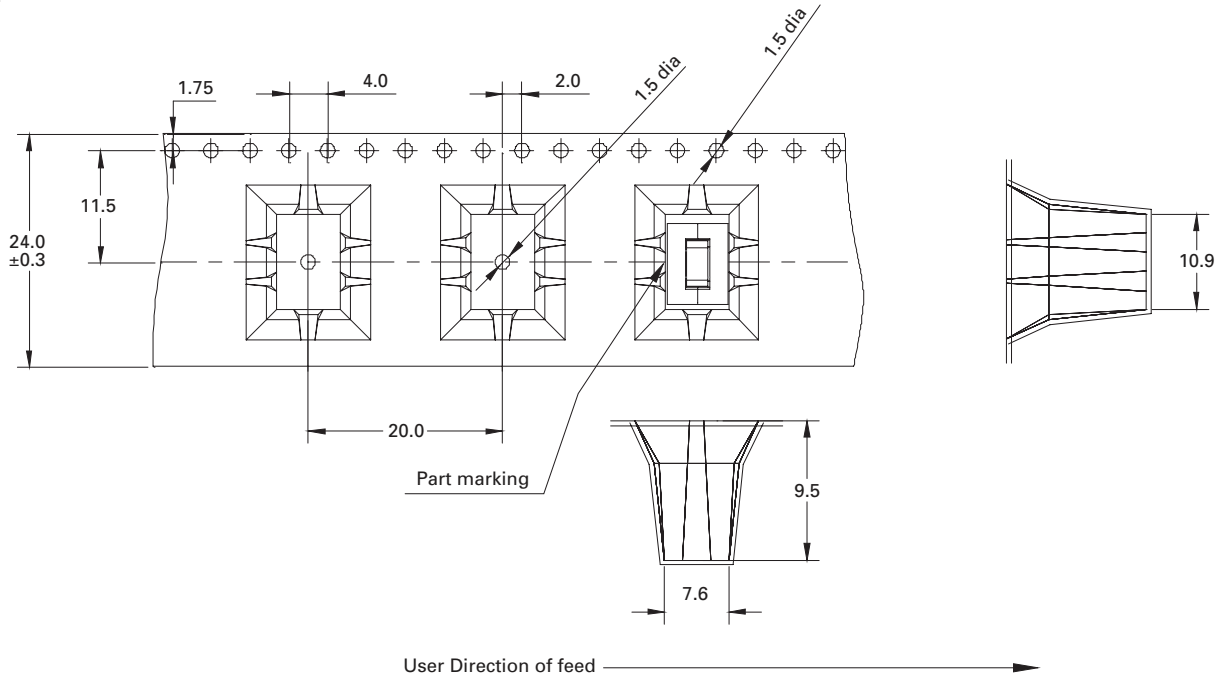

FP1110V2

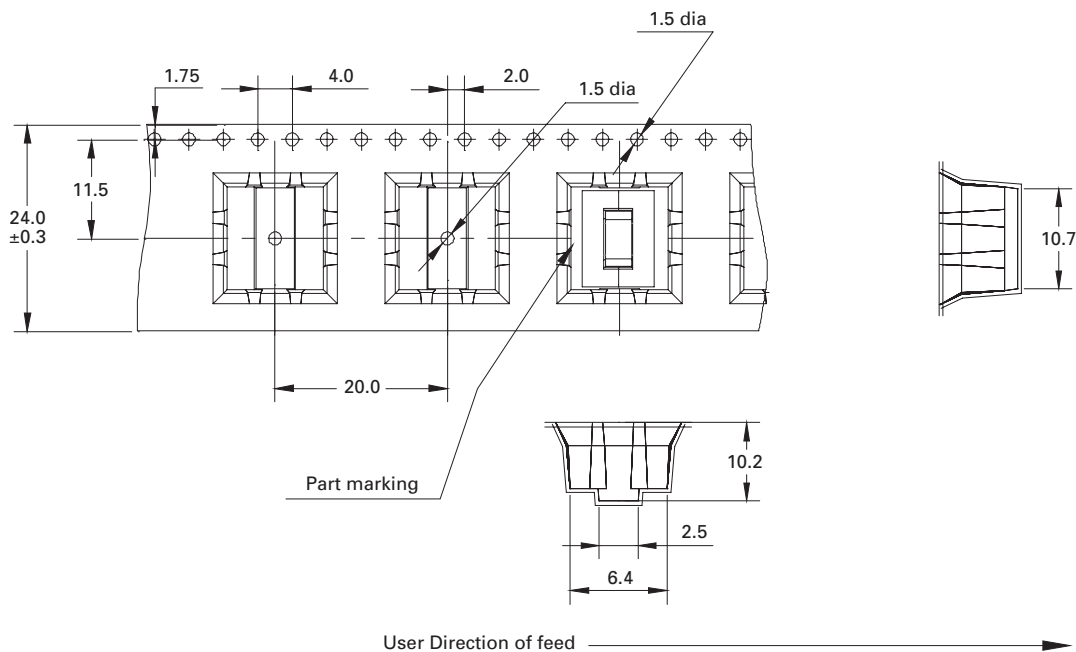

Temperature rise vs. total loss

FP1110V1

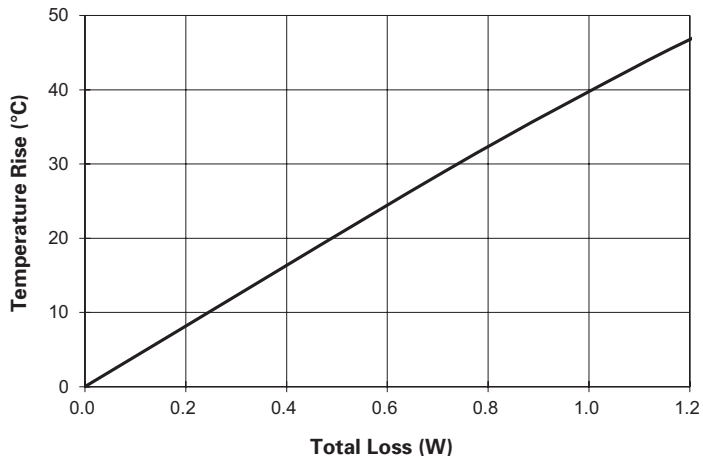

FP1110V2

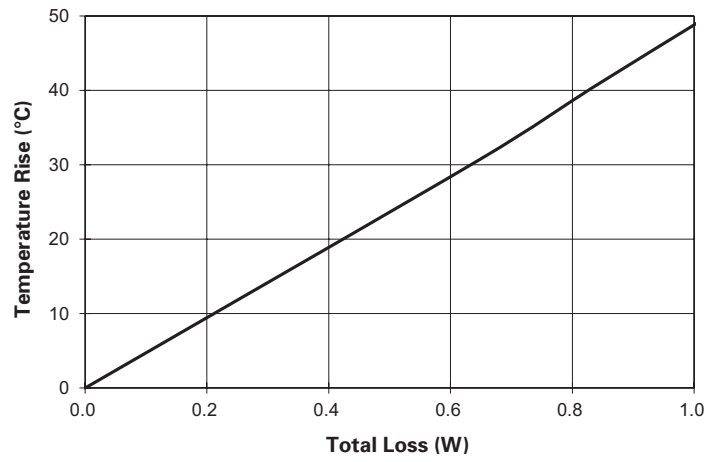

Core loss vs. B_{p-p}

FP1110V1

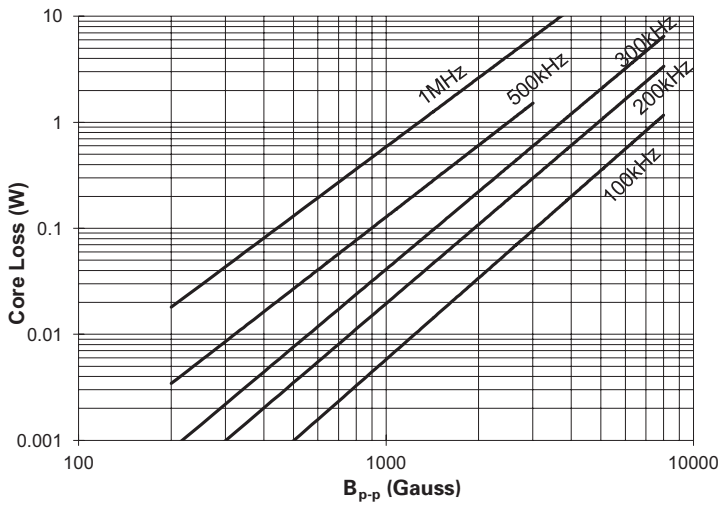

FP1110V2

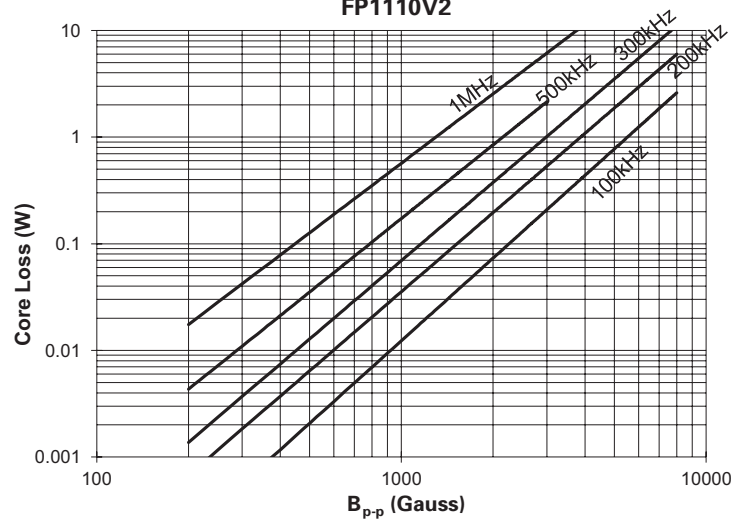

Inductance characteristics

FP1110V1-R20-R

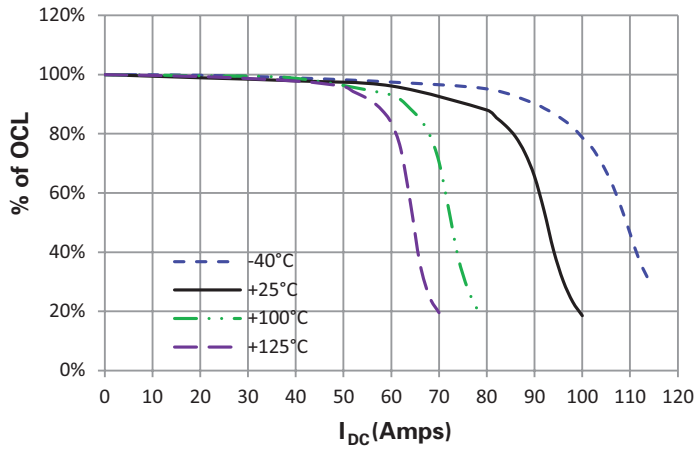

FP1110V1-R22-R

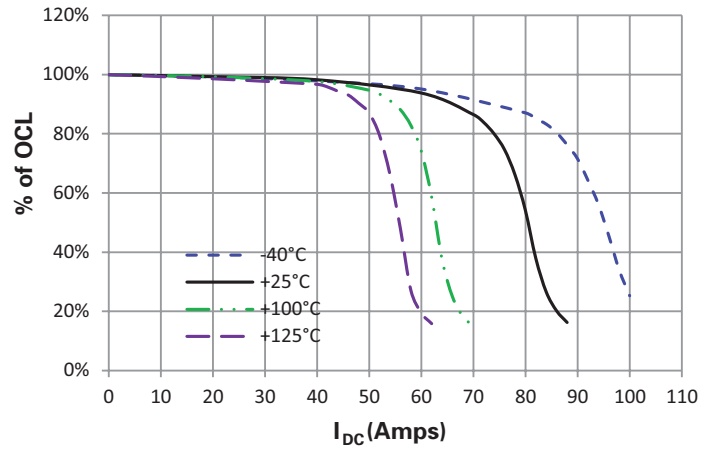

FP1110V1-R27-R

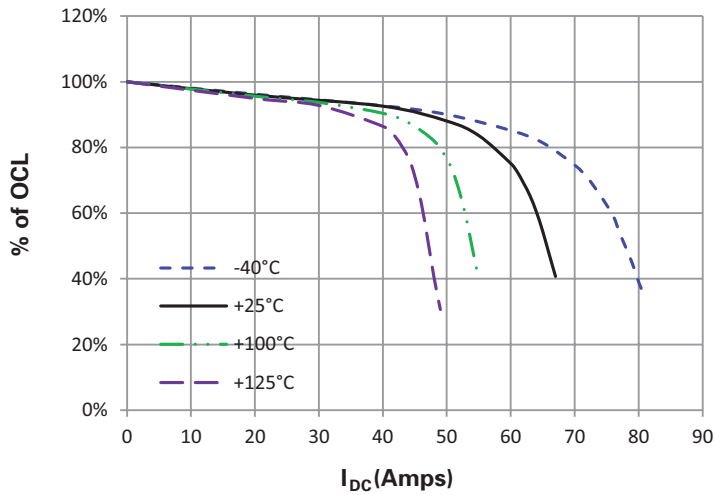

FP1110V1-R32-R

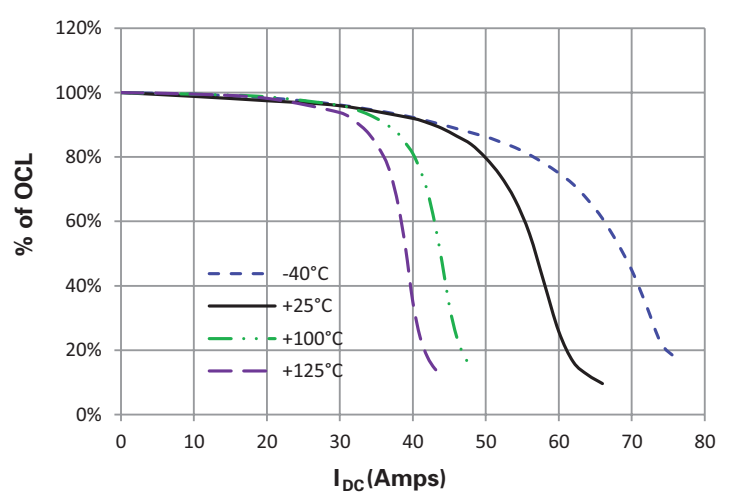

FP1110V2-R200-R

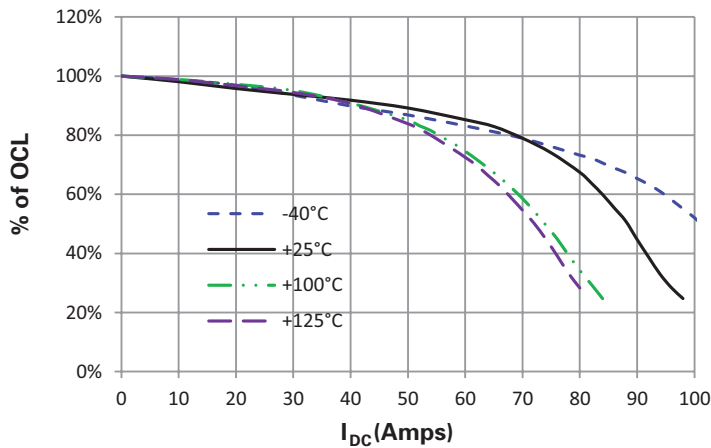

Solder reflow profile

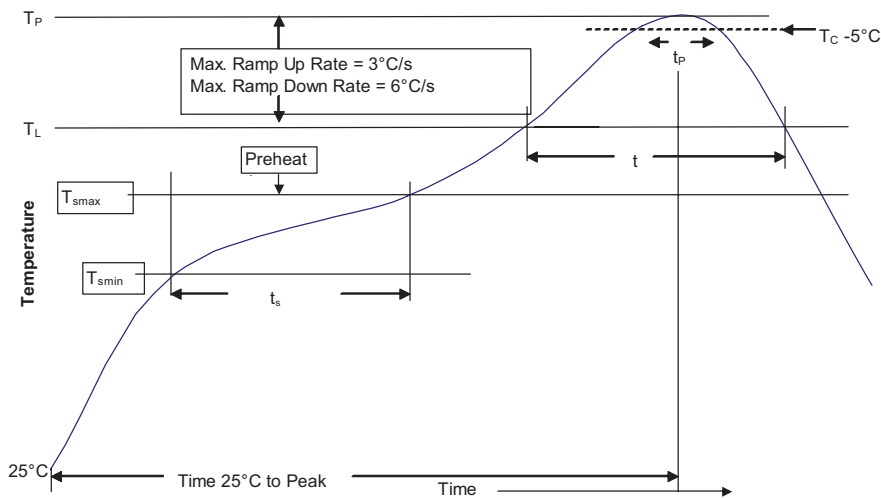

Table 1 - Standard SnPb Solder (T_C)

Package Thickness	Volume mm ³ <350	Volume mm ³ ≥350
<2.5mm)	235°C	220°C
≥2.5mm	220°C	220°C

Table 2 - Lead (Pb) Free Solder (T_C)

Package Thickness	Volume mm ³ <350	Volume mm ³ 350 - 2000	Volume mm ³ >2000
<1.6mm	260°C	260°C	260°C
1.6 - 2.5mm	260°C	250°C	245°C
>2.5mm	250°C	245°C	245°C

Reference JDEC J-STD-020D

Profile Feature	Standard SnPb Solder	Lead (Pb) Free Solder
Preheat and Soak		
• Temperature min. (T _{smin})	100°C	150°C
• Temperature max. (T _{smax})	150°C	200°C
• Time (T _{smin} to T _{smax}) (t _s)	60-120 Seconds	60-120 Seconds
Average ramp up rate T _{smax} to T _p	3°C/ Second Max.	3°C/ Second Max.
Liquidous temperature (T _L)	183°C	217°C
Time at liquidous (t _L)	60-150 Seconds	60-150 Seconds
Peak package body temperature (T _p)*	Table 1	Table 2
Time (t _p)** within 5 °C of the specified classification temperature (T _C)	20 Seconds**	30 Seconds**
Average ramp-down rate (T _p to T _{smax})	6°C/ Second Max.	6°C/ Second Max.
Time 25°C to Peak Temperature	6 Minutes Max.	8 Minutes Max.

* Tolerance for peak profile temperature (T_p) is defined as a supplier minimum and a user maximum.

** Tolerance for time at peak profile temperature (t_p) is defined as a supplier minimum and a user maximum.

Life Support Policy: Eaton does not authorize the use of any of its products for use in life support devices or systems without the express written approval of an officer of the Company. Life support systems are devices which support or sustain life, and whose failure to perform, when properly used in accordance with instructions for use provided in the labeling, can be reasonably expected to result in significant injury to the user.

Eaton reserves the right, without notice, to change design or construction of any products and to discontinue or limit distribution of any products. Eaton also reserves the right to change or update, without notice, any technical information contained in this bulletin.

Eaton
Electronics Division
1000 Eaton Boulevard
Cleveland, OH 44122
United States
www.eaton.com/elx

© 2015 Eaton
All Rights Reserved
Printed in USA
Publication No. 10427 BU-MC15008
August 2015

Eaton is a registered trademark.

All other trademarks are property of their respective owners.