



Chipsmall Limited consists of a professional team with an average of over 10 year of expertise in the distribution of electronic components. Based in Hongkong, we have already established firm and mutual-benefit business relationships with customers from,Europe,America and south Asia,supplying obsolete and hard-to-find components to meet their specific needs.

With the principle of "Quality Parts,Customers Priority,Honest Operation,and Considerate Service",our business mainly focus on the distribution of electronic components. Line cards we deal with include Microchip,ALPS,ROHM,Xilinx,Pulse,ON,Everlight and Freescale. Main products comprise IC,Modules,Potentiometer,IC Socket,Relay,Connector.Our parts cover such applications as commercial,industrial, and automotives areas.

We are looking forward to setting up business relationship with you and hope to provide you with the best service and solution. Let us make a better world for our industry!



Contact us

Tel: +86-755-8981 8866 Fax: +86-755-8427 6832

Email & Skype: info@chipsmall.com Web: www.chipsmall.com

Address: A1208, Overseas Decoration Building, #122 Zhenhua RD., Futian, Shenzhen, China



LISA2-WWW-PIN

~80° wide beam. 7.0 mm high variant with location pin installation.

TECHNICAL SPECIFICATIONS:

Dimensions	Ø 9.9 mm
Height	7 mm
Fastening	glue, pin
Colour	black
Box size	
Box weight	1.4 kg
Quantity in Box	2000 pcs
ROHS compliant	yes ⓘ



MATERIAL SPECIFICATIONS:

Component	Type	Material	Colour
LISA2-WWW	Lens	PMMA	clear
LISA2-HLD-PIN	Holder	PC	black

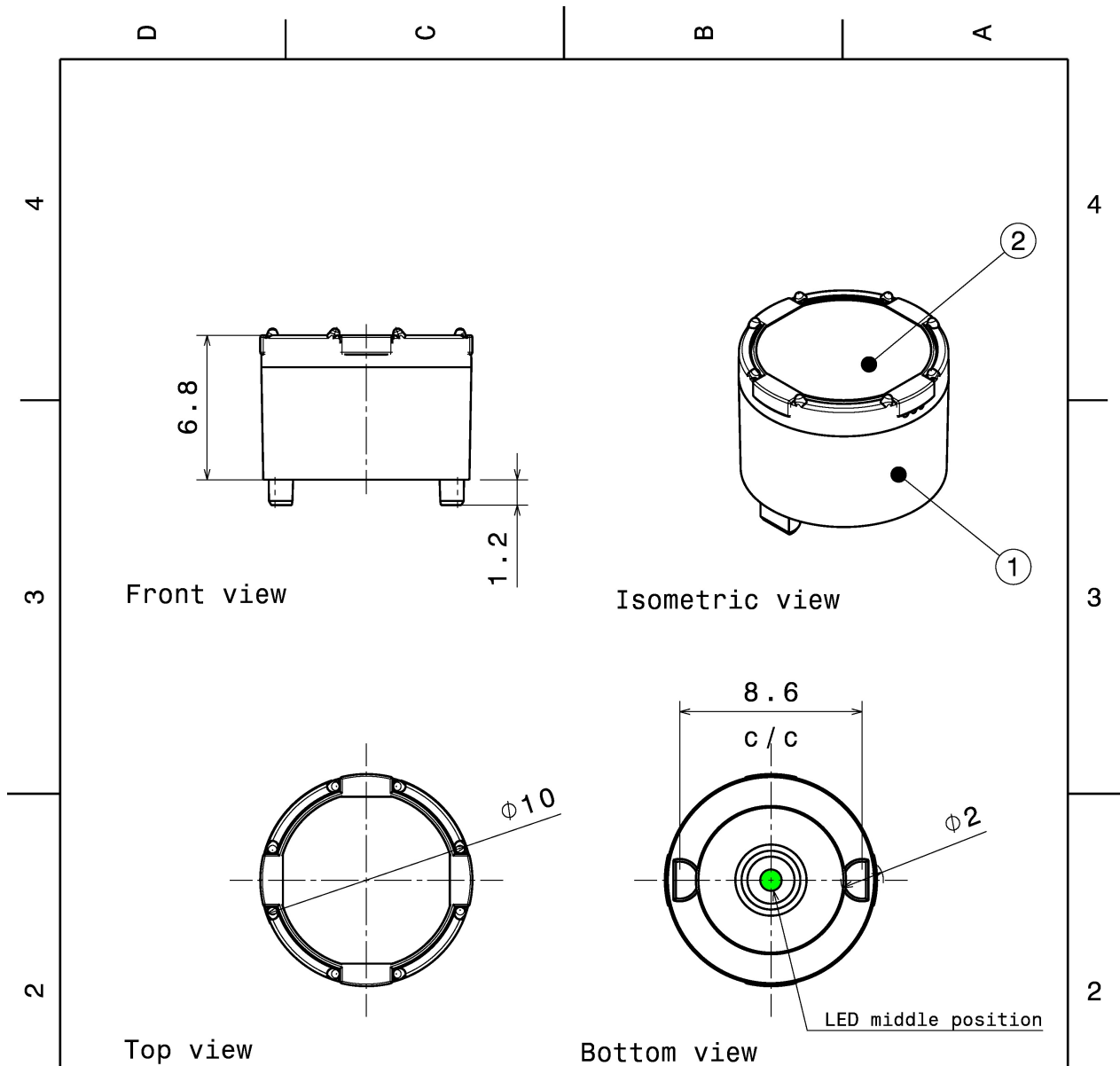

INDEX	PART NO	DESCRIPTION	MATERIAL	COLOUR
1	F10989	LISA2-HLD-PIN	PC	black
2	-	LISA2_lens	PMMA	

Tolerances if not otherwise shown
According to DIN ISO 2768-1
Linear measures:
up to 30mm class M, otherwise class C
According to DIN ISO 2768-2
Form and position: class L

LEDiL

Ledil Oy
Salorankatu 10
FIN 24240 SALO
Finland

THIRD ANGLE PROJECTION: 

DRAWING TITLE
Lisa2-PIN-XP assembly

This drawing is the property of LEDiL Oy. It may not be reproduced, copied or communicated without a written agreement with LEDiL Oy.

SIZE	PART NUMBER
A4	-

SCALE	4:1	WEIGHT	0,5 g	SHEET	1/1
-------	-----	--------	-------	-------	-----

PHOTOMETRIC DATA (MEASURED):

CREE

LED XB-D
FWHM 73.0°
Efficiency 71 %
Peak intensity cd/lm
Required components:

CREE

LED XD16
FWHM 66.0°
Efficiency 66 %
Peak intensity 0.550 cd/lm
Required components:

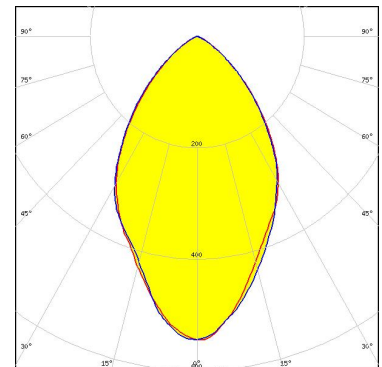
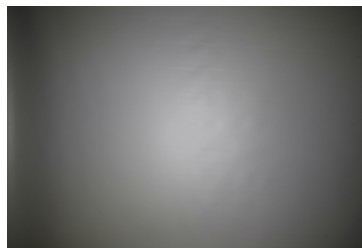

CREE

LED XP-E
FWHM 84.0°
Efficiency 77 %
Peak intensity 0.500 cd/lm
Required components:

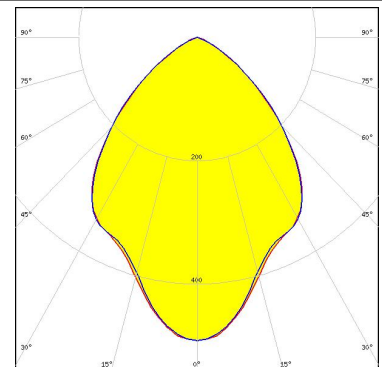
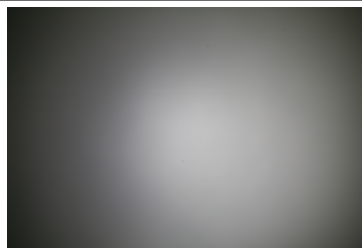

CREE

LED XP-G
FWHM 86.0°
Efficiency 75 %
Peak intensity 0.400 cd/lm
Required components:

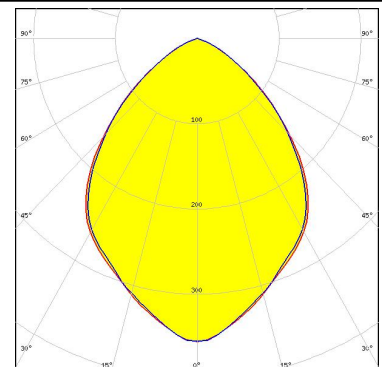

PHOTOMETRIC DATA (MEASURED):

LUMILEDS

LED LUXEON A
FWHM 86.0°
Efficiency 72 %
Peak intensity 0.300 cd/lm
Required components:

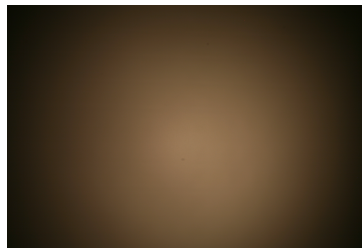

LUMILEDS

LED LUXEON Rebel ES
FWHM 88.0°
Efficiency %
Peak intensity cd/lm
Required components:

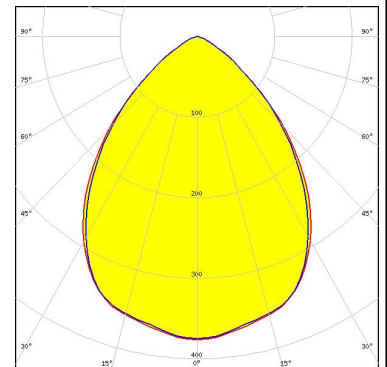

LUMILEDS

LED LUXEON Z
FWHM 73.0°
Efficiency 75 %
Peak intensity 0.600 cd/lm
Required components:

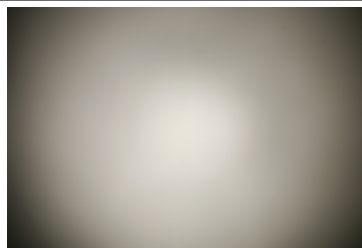

SAMSUNG

LED LH181B
FWHM 62.0°
Efficiency 72 %
Peak intensity 0.640 cd/lm
Required components:

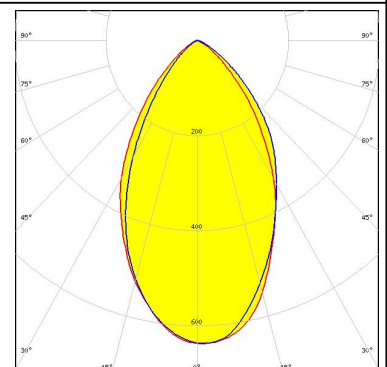
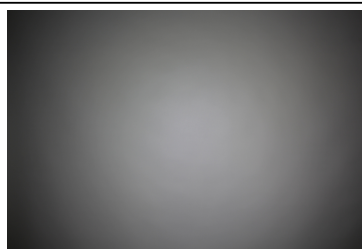

PHOTOMETRIC DATA (SIMULATED):



LED XQ-E
 FWHM 70.0°
 Efficiency 81 %
 Peak intensity 0.600 cd/lm
 Required components:



LED SFH 4715AS
 FWHM 54.0°
 Efficiency 88 %
 Peak intensity 0.960 cd/lm
 Required components:

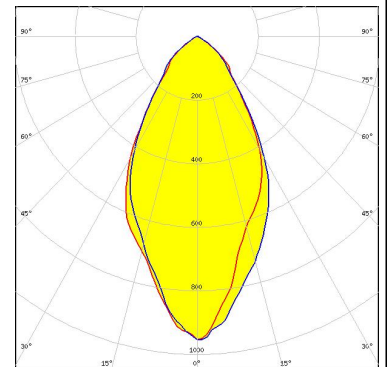

LED Synios P2720 1 mm
 FWHM 74.0°
 Efficiency 87 %
 Peak intensity 0.660 cd/lm
 Required components:

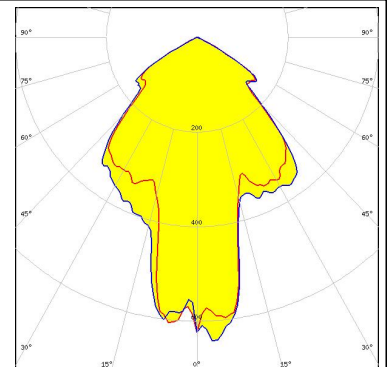

SEOUL SEMICONDUCTOR

LED Z5
 FWHM 70.0°
 Efficiency %
 Peak intensity cd/lm
 Required components:

GENERAL INFORMATION:

NOTE: The typical beam angle will be changed by different color, chip size and chip position tolerance. The typical total beam angle is the full angle measured where the luminous intensity is half of the peak value.

MATERIALS:

As part of our continuous research and improvement processes, and to ensure the best possible quality and availability of our products, LEDiL reserves the right to change material grades without notice.

PRODUCT DATA USER AGREEMENT AND DISCLAIMER:

The measured data in the provided downloadable LEDiL Product Datasheets and Mechanical 2D-Drawings is rounded and provided as reference for planning. LEDiL Oy's optical specifications have been verified by conducting performance testing of the products in accordance with the company's quality system. The reported data are averaged results of multiple measurements with typical variation. LEDiL Oy reserves the right to without prior notification make changes and improvements to its products.

LEDiL Oy assumes neither warranty, nor guarantee nor any other liability of any kind for the contents and correctness of the provided data. The provided data has been generated with highest diligence but the provided data may in reality not represent the complete possible variation range of all intrinsic parameters. Therefore, in certain cases a deviation from the provided data could occur.

LEDiL Oy reserves the right to undertake technical changes of its products without further notification which could lead to changes in the provided data. LEDiL Oy assumes no liability of any kind for the possible deviation from any provided data or any other damage resulting from the usage of the provided data.

The user agrees to this disclaimer and user agreement with the download or usage of the provided files.

LEDiL Oy

Joensuunkatu 13
FI-24240 SALO
Finland

LEDiL Inc.

228 West Page Street
Suite D
Sycamore IL 60178
USA

Local sales and technical support

[www.ledil.com/
where_to_buy](http://www.ledil.com/where_to_buy)

Shipping locations

Salo, Finland
Hong Kong, China

Distribution Partners

[www.ledil.com/
where_to_buy](http://www.ledil.com/where_to_buy)