



Chipsmall Limited consists of a professional team with an average of over 10 year of expertise in the distribution of electronic components. Based in Hongkong, we have already established firm and mutual-benefit business relationships with customers from,Europe,America and south Asia,supplying obsolete and hard-to-find components to meet their specific needs.

With the principle of "Quality Parts,Customers Priority,Honest Operation,and Considerate Service",our business mainly focus on the distribution of electronic components. Line cards we deal with include Microchip,ALPS,ROHM,Xilinx,Pulse,ON,Everlight and Freescale. Main products comprise IC,Modules,Potentiometer,IC Socket,Relay,Connector.Our parts cover such applications as commercial,industrial, and automotives areas.

We are looking forward to setting up business relationship with you and hope to provide you with the best service and solution. Let us make a better world for our industry!



## Contact us

Tel: +86-755-8981 8866 Fax: +86-755-8427 6832

Email & Skype: info@chipsmall.com Web: www.chipsmall.com

Address: A1208, Overseas Decoration Building, #122 Zhenhua RD., Futian, Shenzhen, China



AC/DC Filter 2-Stage, DIN Rail Mounting, Overcurrent and Overvoltage Protection



Housing RI



Housing RI with Circuit Breaker



Housing TI

See below:

**Approvals and Compliances**

**Description**

- Single-phase line filter in standard and medical versions
- 2- Stages filter
- Very high attenuation
- broadband
- Fuseholder
- Thermal circuit breaker
- Surge protection

**Unique Selling Proposition**

- Slim filter for DIN-rail mounting or chassis mounting
- With fuse holder or circuit breaker for equipment
- With overvoltage protection
- Quick wiring with cage clamp terminals

**Characteristics**

- Protection against interference voltage from the mains
- Possible interferences generated in the equipment are strongly attenuated
- Especially designed for electric switch and control cabinets
- Suitable for use in equipment according to IEC/UL 60950
- Suitable for use in medical equipment according to IEC/UL 60601-1

**Weblinks**

[pdf datasheet](#), [html-datasheet](#), [General Product Information](#), [Distributor-Stock-Check](#), [Detailed request for product](#), [Microsite](#), [Landing Page](#)

**Technical Data**

Ratings IEC	1 - 16A @ Ta 40 °C / 250VAC; 50Hz 48/250 VDC
Ratings UL/CSA	1 - 16A @ Ta 40 °C / 125/250VAC; 60Hz 48/250 VDC
Leakage Current	standard < 1 mA (250V / 50Hz)
Dielectric Strength	1.7 kVDC between L-N 2.7 kVDC between L/N-PE Test voltage (2 sec)
Allowable Operation Temperature	-40°C to 100°C
Climatic Category	40/100/21 acc. to IEC 60068-1
IP-Protection	IP 20 IEC 60529
Protection Class	Suitable for appliances with protection class I acc. to IEC 61140
Terminal	Spring cage terminals , 0.2 - 2.5 mm <sup>2</sup> , 24 - 12 AWG
Material: Housing	Plastics, black, UL 94V-0

Circuit Breakers	Acc. IEC/EN 60934, UL 1077, CSA 22.2 no. 235 3 - 15 A Short circuit capacity Icn: 2000 A
Fuseholder	1-pole, Shocksafe category PC2 acc. to IEC 60127-6 for fuse-links 5 x 20mm
Rated Power Acceptance @ Ta 23 °C	5 x 20: 2.5W
Power Acceptance @ Ta > 23°C	Admissible power acceptance at higher ambient temperature see derating curves
Surge protection	Climatic Category 40 / 085 / 21 acc. to IEC 60068-1 320 VAC , 420 VDC , 0.4 W
Line Filter	Standard and Industrial Version, IEC 60939, UL 60939-3, CSA C22.2 no. 8 <a href="#">Technical Details</a>
MTBF	> 200'000h acc. to MIL-HB-217 F



**Approvals and Compliances**

Detailed information on product approvals, code requirements, usage instructions and detailed test conditions can be looked up in [Details about Approvals](#)

## Approvals







The approval mark is used by the testing authorities to certify compliance with the safety requirements placed on electronic products.

Approval Reference Type: FPBB Rail

Approval Logo	Certificates	Certification Body	Description
	VDE Approvals	VDE	Certificate Number: 40047767
	UL Approvals	UL	UL File Number: E495089



## Product standards

Product standards that are referenced

Organization	Design	Standard	Description
	Designed according to	IEC 60320-1	Appliance couplers for household and similar general purposes
	Designed according to	IEC 60939	Passive filters for suppressing electromagnetic interference
	Designed according to	IEC 60127-6	Miniature fuses. Part 6. Fuse-holders for miniature fuse-links
	Designed according to	UL 498	Standard for Attachment Plugs and Receptacles
	Designed according to	UL 60939-3	Electromagnetic interference filters
	Designed according to	CSA C22.2 no. 42	General Use Receptacles, Attachment Plugs, and Similar Wiring Devices
	Designed according to	CSA C22.2 no. 8	Electromagnetic interference (EMI) filters





## Application standards

Application standards where the product can be used

Organization	Design	Standard	Description
	Designed for applications acc.	IEC/UL 60950	IEC 60950-1 includes the basic requirements for the safety of information technology equipment.
	Designed for applications acc.	IEC 60601-1	Medical electrical equipment - Part 1: General requirements for basic safety and essential performance

## Compliances

The product complies with following Guide Lines

Identification	Details	Initiator	Description
	CE declaration of conformity	SCHURTER AG	The CE marking declares that the product complies with the applicable requirements laid down in the harmonisation of Community legislation on its affixing in accordance with EU Regulation 765/2008.
	RoHS	SCHURTER AG	EU Directive RoHS 2011/65/EU
	China RoHS	SCHURTER AG	The law SJ / T 11363-2006 (China RoHS) has been in force since 1 March 2007. It is similar to the EU directive RoHS.
	REACH	SCHURTER AG	On 1 June 2007, Regulation (EC) No 1907/2006 on the Registration, Evaluation, Authorization and Restriction of Chemicals 1 (abbreviated as "REACH") entered into force.
	Medical Equipment	SCHURTER AG	Suitable for use in medical equipment according to IEC/UL 60601-1

Dimension [mm]  
Housing RI

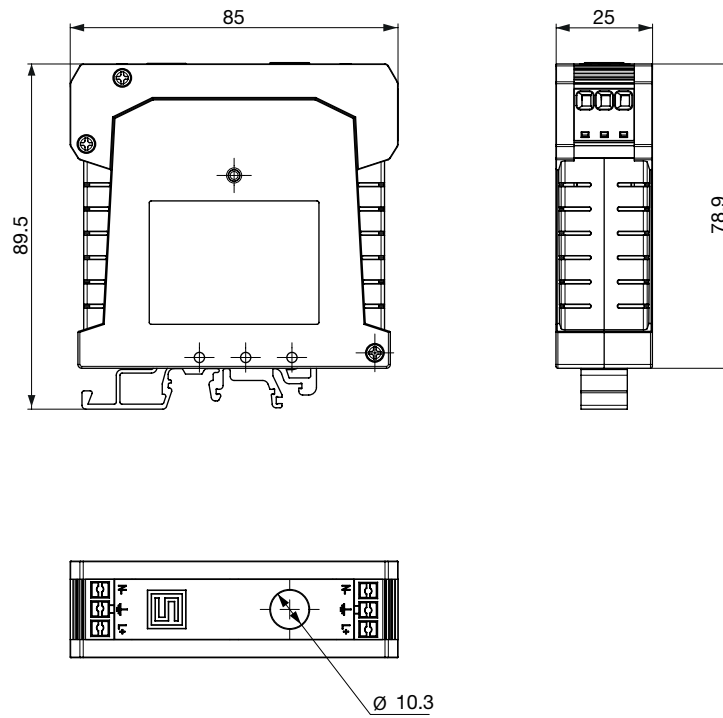

Housing TI

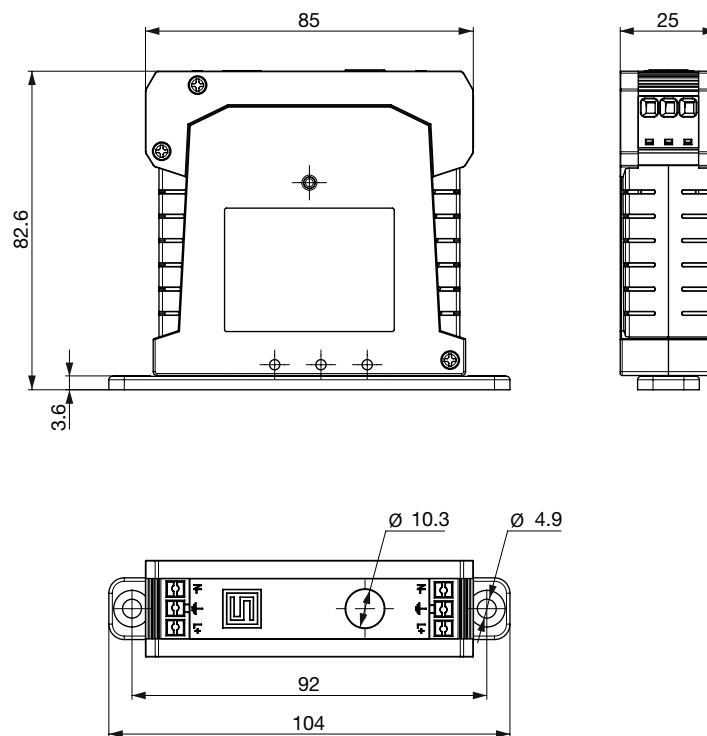

## Diagrams

Diagram S1

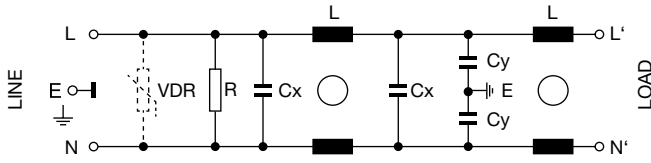

1) Line, 2) Load  
 VDR only for versions with overvoltage protection

Diagram S2

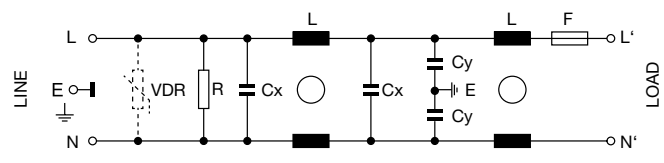

1) Line, 2) Load  
 VDR only for versions with overvoltage protection

Diagram S3

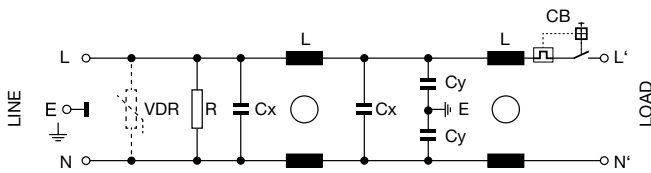

1) Line, 2) Load  
 VDR only for versions with overvoltage protection

Diagram S4

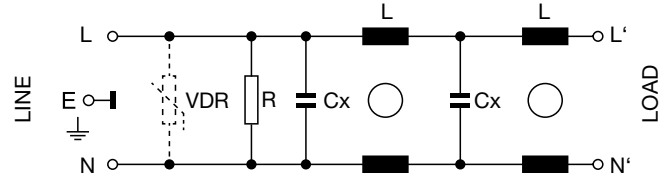

1) Line, 2) Load  
 VDR only for versions with overvoltage protection

Diagram S5

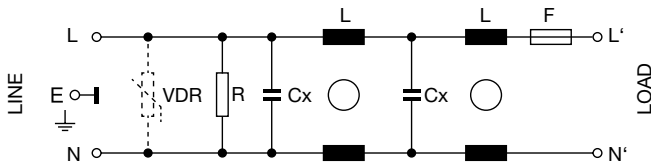

1) Line, 2) Load  
 VDR only for versions with overvoltage protection

Diagram S6

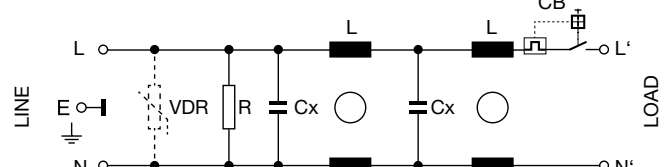

1) Line, 2) Load  
 VDR only for versions with overvoltage protection

## Attenuation Loss

--- 50Ω differential mode \_\_\_\_ 50Ω common mode

Standard version

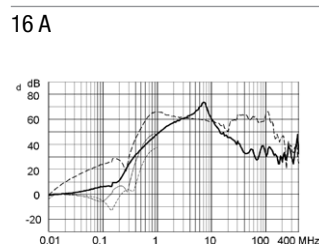
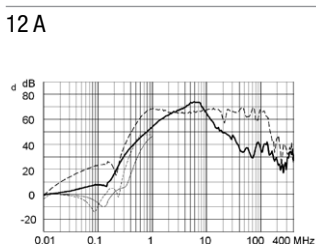
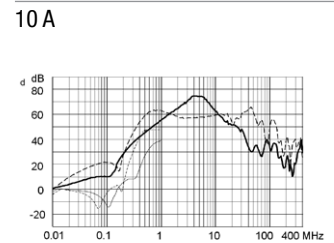
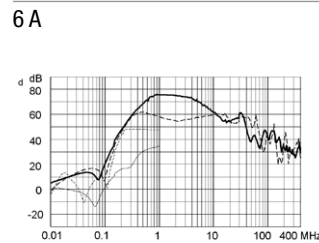
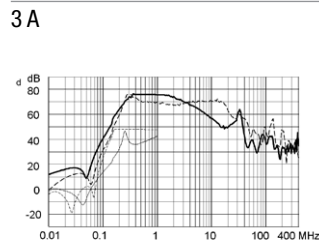
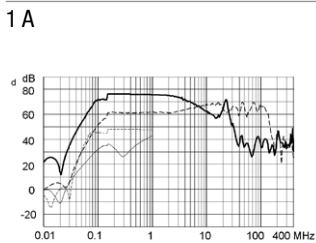

Medical version (M5)

1 A

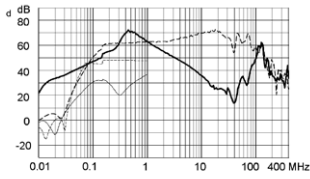

3 A

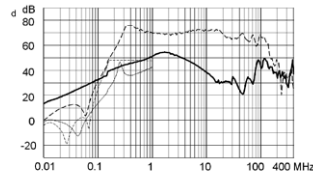

6 A

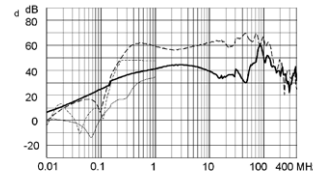

10 A

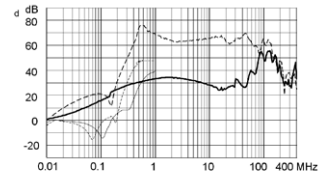

12 A

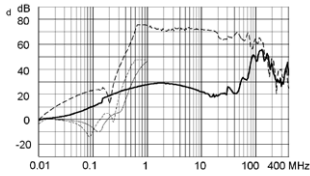

16 A

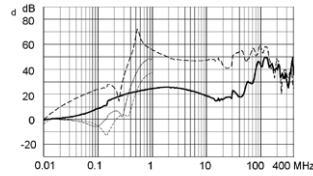

Medical version (M80)

1 A

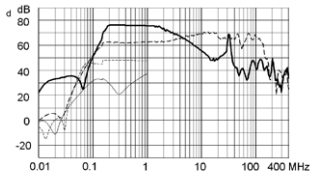

3 A

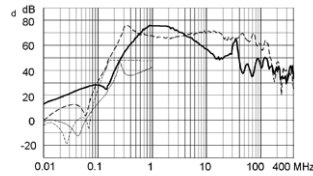

6 A

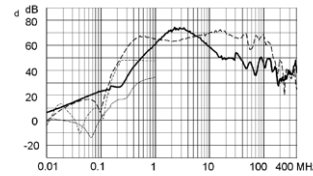

10 A

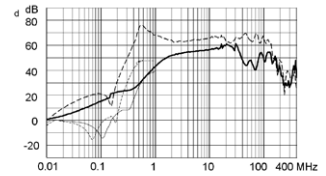

12 A

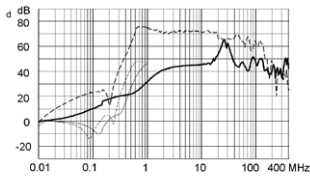

16 A

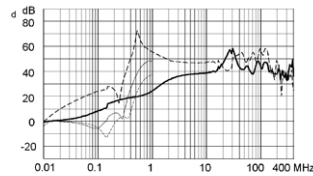

All Variants

Rated current	Rated voltage	Rated voltage	Filter-Type	Leakage Current	Ri	Power Loss	Fuse holder	Circuit-breaker for equipment	Surge protection	Diagram	Housings	Weight	Order Number
[A]	[VAC]	[VDC]		[mA]	[mΩ]	[W]						[g]	
1	250	250	Standard Version	0.5	770	1.3			-	S1	RI	115	<a href="#">3-103-673</a>
1	250	250	Standard Version	0.5	770	1.3			-	S1	TI	115	<a href="#">3-103-714</a>
1	250	250	Standard Version	0.5	780	1.3	●		-	S2	RI	115	<a href="#">3-103-679</a>
1	250	250	Standard Version	0.5	770	1.3			VDR	S1	RI	115	<a href="#">3-103-699</a>
1	250	250	Standard Version	0.5	780	1.3	●		VDR	S2	RI	115	<a href="#">3-103-705</a>
1	250	250	Standard Version	0.5	780	1.3	●		VDR	S2	TI	115	<a href="#">3-103-736</a>
1	250	250	Medical Version (M5)	0.005	770	1.3			-	S4	TI	115	<a href="#">3-103-980</a>
1	250	250	Medical Version (M5)	0.005	780	1.3	●		-	S5	TI	115	<a href="#">3-103-986</a>
3	250	250	Standard Version	0.5	88	1.3			-	S1	RI	115	<a href="#">3-103-674</a>

Rated current	Rated voltage	Rated voltage	Filter-Type	Leakage Current	Ri	Power Loss	Fuse holder	Circuit-breaker for equipment	Surge protection	Diagram	Housings	Weight	Order Number
[A]	[VAC]	[VDC]		[mA]	[mΩ]	[W]						[g]	
3	250	250	Standard Version	0.5	88	1.3			-	S1	TI	115	3-103-715
3	240	48	Standard Version	0.5	250	1.3		●	-	S3	RI	120	3-103-693
3	250	250	Standard Version	0.5	88	1.3			VDR	S1	RI	115	3-103-700
3	250	250	Standard Version	0.5	98	1.3	●		VDR	S2	RI	115	3-103-706
3	250	250	Standard Version	0.5	98	1.3	●		VDR	S2	TI	115	3-103-737
3	240	48	Standard Version	0.5	250	1.3		●	VDR	S3	RI	120	3-103-709
3	240	48	Standard Version	0.5	250	1.3		●	VDR	S3	TI	120	3-103-720
3	250	250	Medical Version (M5)	0.005	88	1.3			-	S4	TI	115	3-103-981
3	250	250	Medical Version (M5)	0.005	98	1.3	●		-	S5	TI	115	3-103-987
6	250	250	Standard Version	0.5	30	1.73			-	S1	RI	115	3-103-675
6	250	250	Standard Version	0.5	30	1.73			-	S1	TI	115	3-103-716
6	250	250	Standard Version	0.5	40	1.73	●		-	S2	RI	115	3-103-681
6	250	250	Standard Version	0.5	30	1.73			VDR	S1	RI	115	3-103-701
6	250	250	Standard Version	0.5	40	1.73	●		VDR	S2	RI	115	3-103-707
6	250	250	Standard Version	0.5	40	1.73	●		VDR	S2	TI	115	3-103-738
6	240	48	Standard Version	0.5	60	1.3		●	VDR	S3	RI	120	3-103-710
6	240	48	Standard Version	0.5	60	1.73		●	VDR	S3	TI	120	3-103-721
6	250	250	Medical Version (M5)	0.005	30	1.73			-	S4	TI	115	3-103-982
6	250	250	Medical Version (M5)	0.005	40	1.73	●		-	S5	TI	115	3-103-988
10	250	250	Standard Version	0.5	25	2.64			-	S1	RI	115	3-103-676
10	250	250	Standard Version	0.5	25	2.64			-	S1	TI	115	3-103-717
10	240	48	Standard Version	0.5	30	2.64		●	-	S3	RI	120	3-103-695
10	250	250	Standard Version	0.5	25	2.64			VDR	S1	RI	115	3-103-702
10	250	250	Standard Version	0.5	35	2.64	●		VDR	S2	RI	115	3-103-708
10	250	250	Standard Version	0.5	35	2.64	●		VDR	S2	TI	115	3-103-739
10	240	48	Standard Version	0.5	30	2.64		●	VDR	S3	RI	120	3-103-711
10	240	48	Standard Version	0.5	30	2.64		●	VDR	S3	TI	120	3-103-752
10	250	250	Medical Version (M5)	0.005	25	2.64			-	S4	TI	115	3-103-983
10	250	250	Medical Version (M5)	0.005	35	2.64	●		-	S5	TI	115	3-103-989
12	250	250	Standard Version	0.5	12	1.6			-	S1	RI	115	3-103-677
12	250	250	Standard Version	0.5	12	1.6			-	S1	TI	115	3-103-718
12	250	250	Standard Version	0.5	12	1.6			VDR	S1	RI	115	3-103-703
12	240	48	Standard Version	0.5	25	1.6		●	VDR	S3	RI	120	3-103-712

Rated current	Rated voltage	Rated voltage	Filter-Type	Leakage Current	Ri	Power Loss	Fuse holder	Circuit-breaker for equipment	Surge protection	Diagram	Housings	Weight	Order Number
[A]	[VAC]	[VDC]		[mA]	[mΩ]	[W]						[g]	
12	240	48	Standard Version	0.5	25	1.6		●	VDR	S3	TI	120	3-103-753
12	250	250	Medical Version (M5)	0.005	12	1.6			-	S4	TI	115	3-103-984
15	240	32	Standard Version	0.5	20	1.55		●	VDR	S3	RI	120	3-103-713
15	240	32	Standard Version	0.5	20	1.55		●	VDR	S3	TI	120	3-103-754
16	250	250	Standard Version	0.5	8	1.55			-	S1	RI	115	3-103-678
16	250	250	Standard Version	0.5	8	1.55			-	S1	TI	115	3-103-719
16	250	250	Standard Version	0.5	8	1.55			VDR	S1	RI	115	3-103-704
16	250	250	Medical Version (M5)	0.005	8	1.55			-	S4	TI	115	3-103-985

Most Popular.

Availability for all products can be searched real-time: <https://www.schurter.com/en/Stock-Check/Stock-Check-SCHURTER>

**Packaging unit** 20 Pcs