



Chipsmall Limited consists of a professional team with an average of over 10 year of expertise in the distribution of electronic components. Based in Hongkong, we have already established firm and mutual-benefit business relationships with customers from,Europe,America and south Asia,supplying obsolete and hard-to-find components to meet their specific needs.

With the principle of “Quality Parts,Customers Priority,Honest Operation,and Considerate Service”,our business mainly focus on the distribution of electronic components. Line cards we deal with include Microchip,ALPS,ROHM,Xilinx,Pulse,ON,Everlight and Freescale. Main products comprise IC,Modules,Potentiometer,IC Socket,Relay,Connector.Our parts cover such applications as commercial,industrial, and automotives areas.

We are looking forward to setting up business relationship with you and hope to provide you with the best service and solution. Let us make a better world for our industry!



Contact us

Tel: +86-755-8981 8866 Fax: +86-755-8427 6832

Email & Skype: info@chipsmall.com Web: www.chipsmall.com

Address: A1208, Overseas Decoration Building, #122 Zhenhua RD., Futian, Shenzhen, China



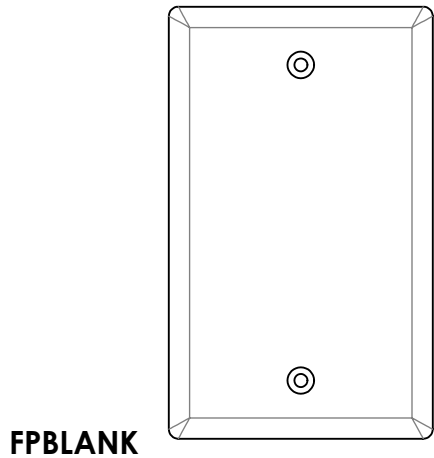

FPBLANK

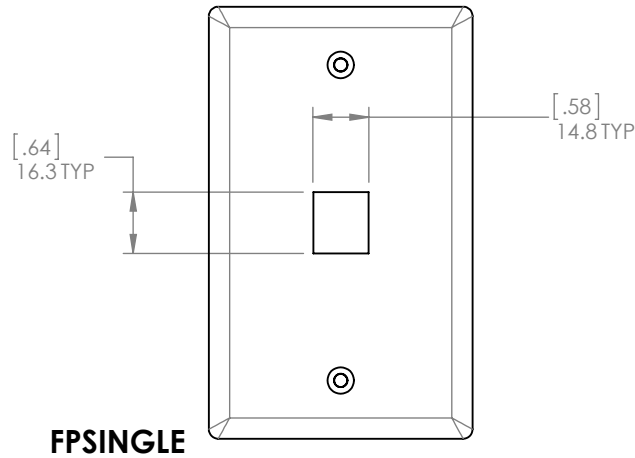
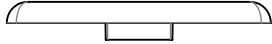

FPSINGLE

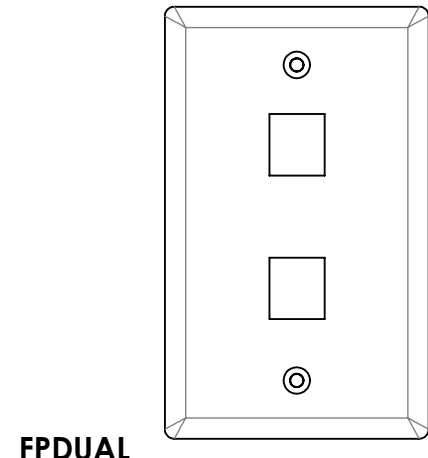
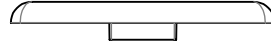

FPDUAL

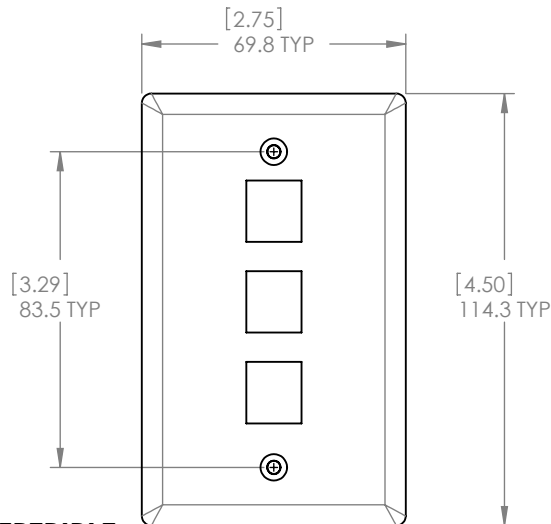
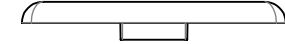

FPTRIPLE

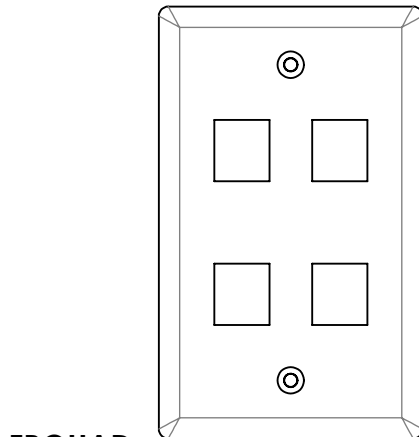

FPQUAD

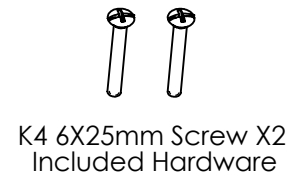

FPSIX

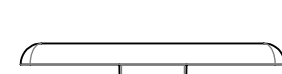
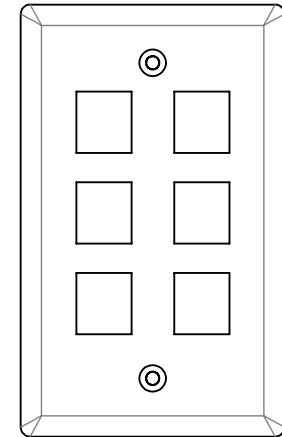

INVENTORS

HellermannTyton®

ALL PROPRIETARY RIGHTS IN THE SUBJECT MATTER SHOWN ON THIS DRAWING ARE EXCLUSIVE PROPERTY OF TYTON HELLERMANN

name	date	city, state

REVISION

level	01
by	SNH
date	5/12/15
ECN #	??????
part level	A

DIMENSIONS

.xxxx	= [±.0005] / ±.013
.xxx	= [±.005] / ±.13
.xx	= [±.01] / ±.3
.x	= [±.03] / ±.8
∠	= ±0.5°
unless otherwise specified	
units	[inches] / mm

PART

number	SEE ABOVE	phase	PRODUCTION
name FP FACE PLATES			
material ABS UL94V-0 CONSULT TYTON FOR AVAIL. COLORS			

DRAWING

FORMAT#	VERSION J	CAD	SW	scale	1/2X
computer file number	MIMI3013001SER_01			previous number	
drawn	K.A.C.	checked	MEF	approved	
	7/28/98		08/06/98		
type	SERIES			sheet	1 of 1
number	MI3013001SER				