



Chipsmall Limited consists of a professional team with an average of over 10 year of expertise in the distribution of electronic components. Based in Hongkong, we have already established firm and mutual-benefit business relationships with customers from,Europe,America and south Asia,supplying obsolete and hard-to-find components to meet their specific needs.

With the principle of "Quality Parts,Customers Priority,Honest Operation,and Considerate Service",our business mainly focus on the distribution of electronic components. Line cards we deal with include Microchip,ALPS,ROHM,Xilinx,Pulse,ON,Everlight and Freescale. Main products comprise IC,Modules,Potentiometer,IC Socket,Relay,Connector.Our parts cover such applications as commercial,industrial, and automotives areas.

We are looking forward to setting up business relationship with you and hope to provide you with the best service and solution. Let us make a better world for our industry!



## Contact us

Tel: +86-755-8981 8866 Fax: +86-755-8427 6832

Email & Skype: info@chipsmall.com Web: www.chipsmall.com

Address: A1208, Overseas Decoration Building, #122 Zhenhua RD., Futian, Shenzhen, China





Is Now Part of



**ON Semiconductor®**

To learn more about ON Semiconductor, please visit our website at  
[www.onsemi.com](http://www.onsemi.com)

ON Semiconductor and the ON Semiconductor logo are trademarks of Semiconductor Components Industries, LLC dba ON Semiconductor or its subsidiaries in the United States and/or other countries. ON Semiconductor owns the rights to a number of patents, trademarks, copyrights, trade secrets, and other intellectual property. A listing of ON Semiconductor's product/patent coverage may be accessed at [www.onsemi.com/site/pdf/Patent-Marking.pdf](http://www.onsemi.com/site/pdf/Patent-Marking.pdf). ON Semiconductor reserves the right to make changes without further notice to any products herein. ON Semiconductor makes no warranty, representation or guarantee regarding the suitability of its products for any particular purpose, nor does ON Semiconductor assume any liability arising out of the application or use of any product or circuit, and specifically disclaims any and all liability, including without limitation special, consequential or incidental damages. Buyer is responsible for its products and applications using ON Semiconductor products, including compliance with all laws, regulations and safety requirements or standards, regardless of any support or applications information provided by ON Semiconductor. "Typical" parameters which may be provided in ON Semiconductor data sheets and/or specifications can and do vary in different applications and actual performance may vary over time. All operating parameters, including "Typicals" must be validated for each customer application by customer's technical experts. ON Semiconductor does not convey any license under its patent rights nor the rights of others. ON Semiconductor products are not designed, intended, or authorized for use as a critical component in life support systems or any FDA Class 3 medical devices or medical devices with a same or similar classification in a foreign jurisdiction or any devices intended for implantation in the human body. Should Buyer purchase or use ON Semiconductor products for any such unintended or unauthorized application, Buyer shall indemnify and hold ON Semiconductor and its officers, employees, subsidiaries, affiliates, and distributors harmless against all claims, costs, damages, and expenses, and reasonable attorney fees arising out of, directly or indirectly, any claim of personal injury or death associated with such unintended or unauthorized use, even if such claim alleges that ON Semiconductor was negligent regarding the design or manufacture of the part. ON Semiconductor is an Equal Opportunity/Affirmative Action Employer. This literature is subject to all applicable copyright laws and is not for resale in any manner.



# FPF2310/12/13/13L Dual-Output Adjustable Current Limit Switch

## Features

- 1.8 to 5.5V Input Voltage Range
- Typical  $R_{ON} = 75m\Omega$  at  $I_N = 5.5V$
- 400~600mA Adjustable Current Limit
- 10% Current Limit Accuracy from Typical
- Slew Rate Controlled
- ESD Protected, Above 4000V HBM
- Independent Thermal Shutdown
- UVLO
- Output Discharge
- RoHS Compliant



## Applications

- Smart Phones
- Enterprise Equipment
- Peripheral USB Ports and Accessories

## Related Resources

[FPF2310/12/13/13L Evaluation Board User Guide: Power Switch for USB Applications](#)

## Description

The FPF2310/12/13/13L are dual-channel load switches of the IntelliMAX™ family. The FPF2310/12/13/13L consist of dual, independent, current-limited, and slew rate controlled, P-channel MOSFET power switches. Slew rated turn-on prevents inrush current from glitching supply rails. The input voltage range operates from 1.8V to 5.5V to fulfill USB device supply requirements. Switch control is accomplished by a logic input (ON) capable of interfacing directly with low-voltage control signals.

For the FPF2312, if the constant-current condition persists after 10ms, the part shuts down the switch. The FPF2310 has an auto-restart feature that turns the switch on again after 150ms if the ON pin is still active. FPF2313/13L remains in constant-current mode until the switch current falls below the current limit. For FPF2310 through FPF2313/13L, the minimum current limit is 400mA-600mA with 10% accuracy (+25°C) for each switch to comply with USB applications in portable devices.

FPF2310M/12/13/13L series is available in a space-saving, 8-Lead, 3x3mm MLP.

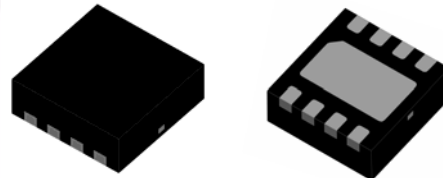

Figure 1. 8-Lead MLP (3x3mm)

## Ordering Information

Part Number	Minimum Current Limit	Current Limit Blanking Time	Auto Restart	ON Pin Activity	Mode	Package
FPF2310MPX	400-600mA	10ms	150ms	Active HIGH	Restart	8-Lead Molded Leadless Package
FPF2312MPX	400-600mA	10ms	N/A	Active HIGH	Latch Off	8-Lead Molded Leadless Package
FPF2313MPX	400-600mA	0ms	N/A	Active HIGH	Constant Current	8-Lead Molded Leadless Package
FPF2313LMPX	400-600mA	0ms	N/A	Active LOW	Constant Current	8-Lead Molded Leadless Package

### Application Circuit

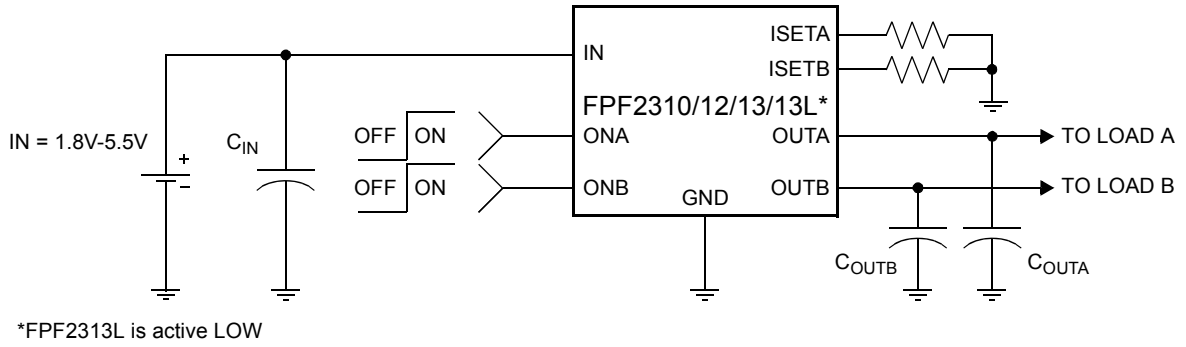

Figure 2. Typical Application

### Functional Block Diagram

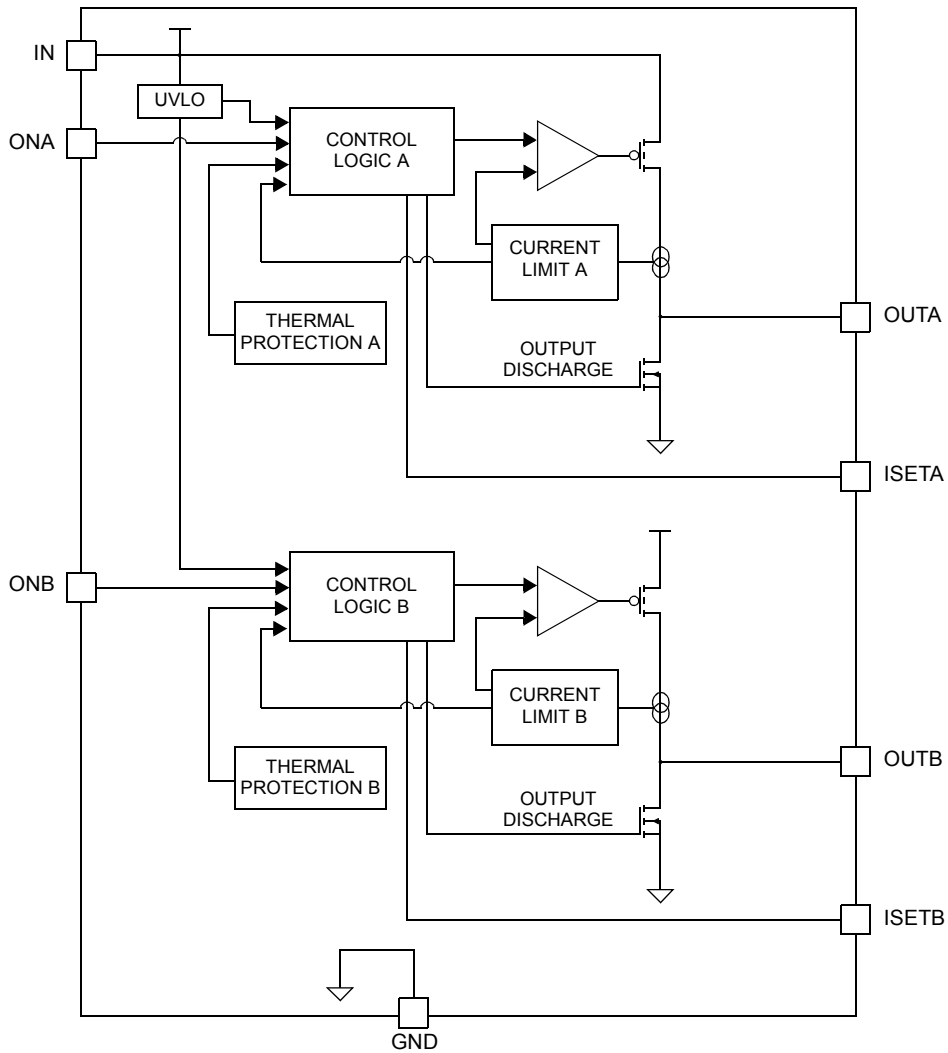
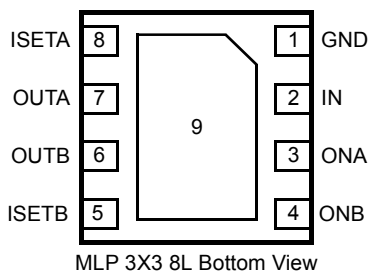

Figure 3. Block Diagram



## Pin Configuration



**Figure 4. 8-Lead MLP 3x3mm (Bottom View)**

## Pin Description

Pin	Name	Function
1	GND	Ground
2	IN	Supply Input: Input to the power switch and the supply voltage for the IC.
3	ONA	ON / OFF control input of power switch A.
4	ONB	ON / OFF control input of power switch B.
5	ISETB	Current limit set input for power switch B: A resistor from ISET to ground sets the current limit for the switch.
6	OUTB	Switch Output: output of the power switch B.
7	OUTA	Switch Output: output of the power switch A.
8	ISETA	Current limit set input for power switch A: A resistor from ISET to ground sets the current limit for the switch.
9	Thermal Pad	IC substrate, which can be connected to GND for better thermal performance. Do not connect to other pins.

## Absolute Maximum Ratings

Stresses exceeding the absolute maximum ratings may damage the device. The device may not function or be operable above the recommended operating conditions and stressing the parts to these levels is not recommended. In addition, extended exposure to stresses above the recommended operating conditions may affect device reliability. The absolute maximum ratings are stress ratings only.

Symbol	Parameter	Min.	Max.	Unit
	IN, OUTA, OUTB, ON to GND	-0.3	6.0	V
$P_D$	Power Dissipation		0.6 <sup>(1.)</sup>	W
			2.2 <sup>(2.)</sup>	
$T_{STG}$	Storage Temperature	-65	+150	°C
$\theta_{JA}$	Thermal Resistance, Junction-to-Ambient		216 <sup>(1.)</sup>	°C/W
			57 <sup>(2.)</sup>	
ESD	Electrostatic Discharge Protection	Human Body Model, JESD22-A114	4000	V
		Charged Device Model, JESD22-C101	2000	V

### Notes:

- Soldered thermal pad on a two-layer PCB without vias based on JEDEC STD 51-3.
- Soldered thermal pad on a four-layer PCB without vias connected with GND plane based on JEDEC STD51-5, 7.

## Recommended Operating Range

The Recommended Operating Conditions table defines the conditions for actual device operation. Recommended operating conditions are specified to ensure optimal performance to the datasheet specifications. Fairchild does not recommend exceeding them or designing to absolute maximum ratings.

Symbol	Parameter	Min.	Max.	Unit
IN	Supply Input	1.8	5.5	V
$T_A$	Ambient Operating Temperature	-40	+85	°C

## Electrical Characteristics

IN = 1.8 to 5.5V, TA = -40 to +85°C unless otherwise noted. Typical values are at IN = 3.3V and TA = 25°C.

Symbol	Parameter	Conditions	Min.	Typ.	Max.	Units
<b>Basic Operation</b>						
V <sub>IN</sub>	Operating Voltage		1.8		5.5	V
I <sub>Q</sub>	Quiescent Current	IN = 5.5V, I <sub>OUT</sub> = 0mA, V <sub>ON</sub> = 5.5V (FPF2310/2/3), V <sub>ON</sub> = 0V (FPF2313L)		52.5	94.5	μA
I <sub>SD</sub>	IN Shutdown Current	IN = 5.5V, OUTA = OUTB = Short to GND, V <sub>ON</sub> = 0V (FPF2310/2/3), V <sub>ON</sub> = 5.5V (FPF2313L)			1	μA
R <sub>ON</sub>	On Resistance	IN = 5.5V, I <sub>OUT</sub> = 200mA, T <sub>A</sub> = 25°C		75	140	mΩ
		IN = 5.5V, I <sub>OUT</sub> = 200mA, T <sub>A</sub> = -40°C to +85°C		90		
R <sub>PD</sub>	Output Pull-Down Resistance	IN = 3.3V, T <sub>A</sub> = 25°C V <sub>ON</sub> = 0V (FPF2310/2/3), V <sub>ON</sub> = 3.3V (FPF2313L)		70		Ω
V <sub>IH</sub>	ON Input Logic High Voltage (ON)	IN = 1.8V	0.8			V
		IN = 5.5V	1.4			
V <sub>IL</sub>	ON Input Logic Low Voltage	IN = 1.8V			0.5	V
		IN = 5.5V			0.9	
I <sub>ON</sub>	ON Input Leakage	V <sub>ON</sub> = IN or GND	-1		1	μA
<b>Protections</b>						
I <sub>LIM</sub>	Current Limit	IN = 3.3V, OUTA = OUTB = 3V, R <sub>SET</sub> = 690Ω, T <sub>A</sub> = 25°C	450	500	550	mA
TSD	Thermal Shutdown	Shutdown Threshold		140		°C
		Return from Shutdown		130		
		Hysteresis		10		
V <sub>UVLO</sub>	Under-Voltage Shutdown	IN Increasing	1.55	1.65	1.75	V
V <sub>UVLO_HYS</sub>	Under-Voltage Shutdown Hysteresis			50		mV
<b>Dynamic</b>						
t <sub>ON</sub>	Turn-On Time	R <sub>L</sub> = 500Ω, C <sub>L</sub> = 0.1μF		111		μs
t <sub>OFF</sub>	Turn-Off Time	R <sub>L</sub> = 500Ω		5		μs
t <sub>R</sub>	OUTA, OUTB Rise Time	R <sub>L</sub> = 500Ω, C <sub>L</sub> = 0.1μF		13		μs
t <sub>F</sub>	OUTA, OUTB Fall Time	R <sub>L</sub> = 500Ω		2		μs
t <sub>BLANK</sub>	Over-Current Blanking Time	FPF2310, FPF2312	5	10	20	ms
t <sub>RSTRT</sub>	Auto-Restart Time	FPF2310	75	150	300	ms
t <sub>CLR</sub>	Current Limit Response Time	IN = 3.3V, Moderate Over-Current Condition		20		μs

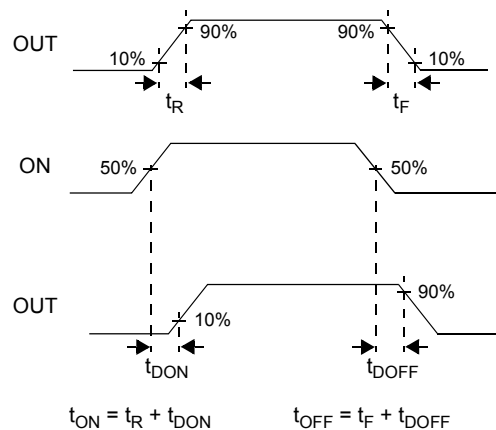

**Figure 5. Timing Diagram**

## Typical Characteristics

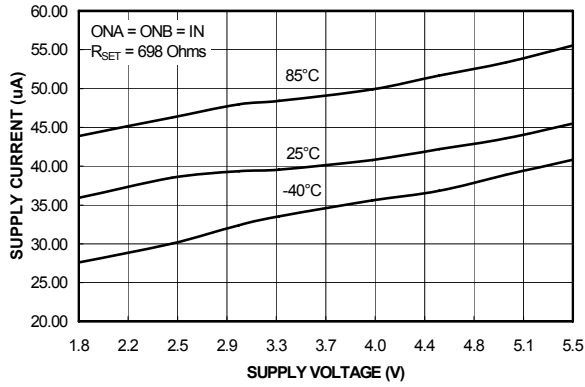

Figure 6. Quiescent Current vs. Supply Voltage

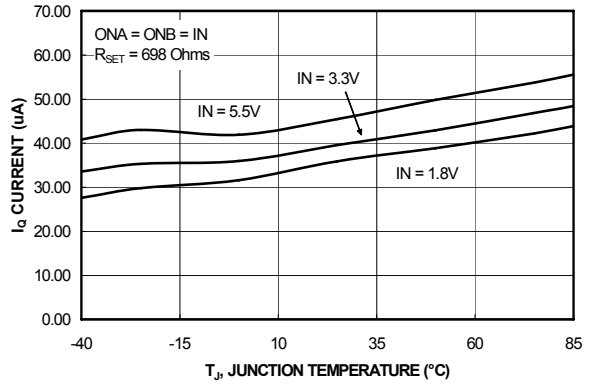

Figure 7. Quiescent Current vs. Temperature

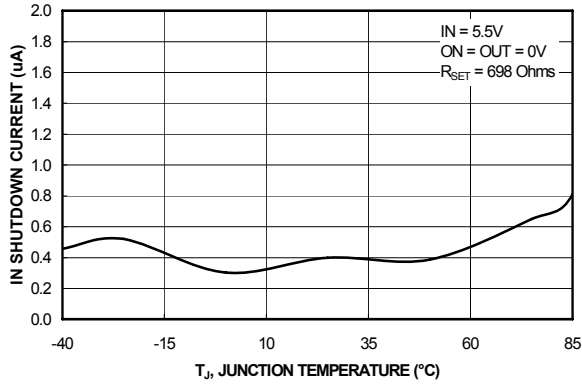

Figure 8. IN Shutdown Current vs. Temperature

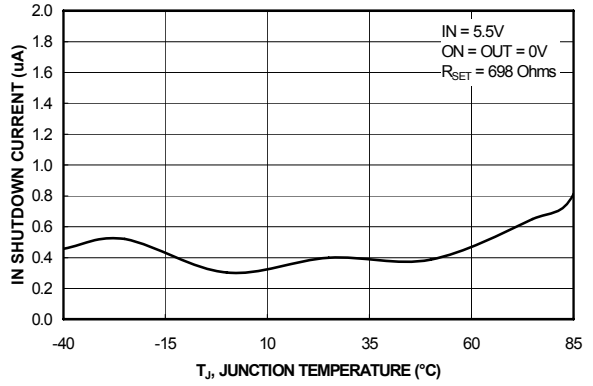

Figure 9.  $R_{ON}$  vs. Supply Voltage

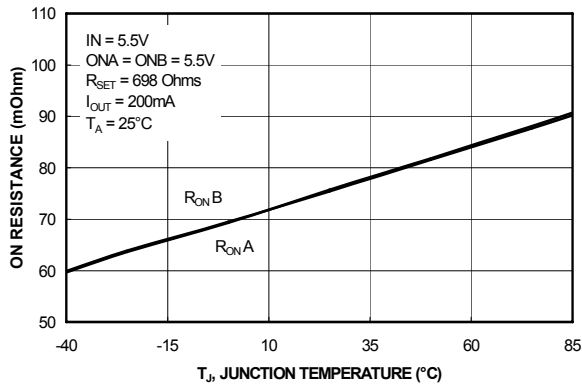

Figure 10.  $R_{ON}$  vs. Temperature

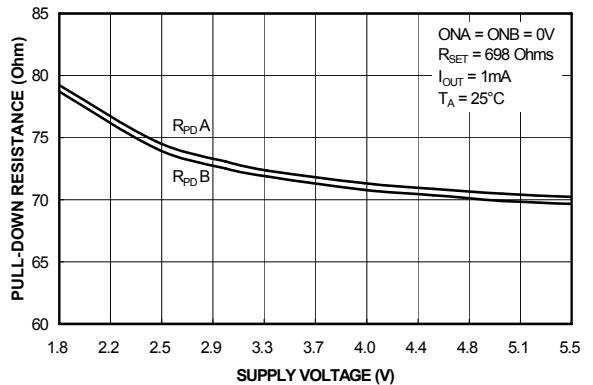

Figure 11.  $R_{PD}$  vs. Supply Voltage



### Typical Characteristics

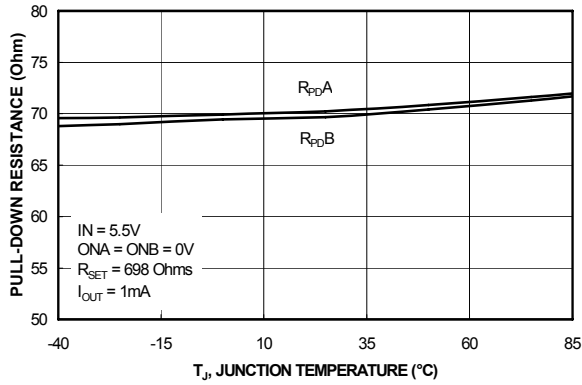

Figure 12.  $R_{PD}$  vs. Temperature

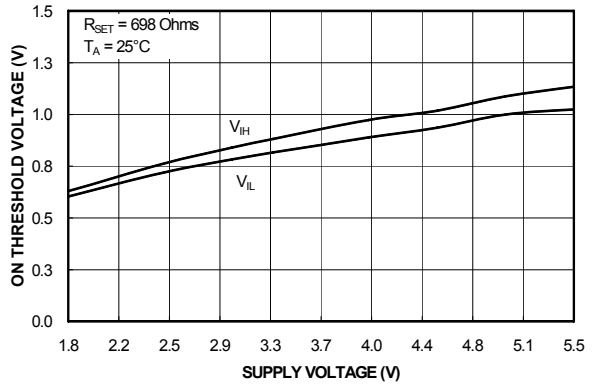

Figure 13. ON Threshold Voltage vs. Supply Voltage

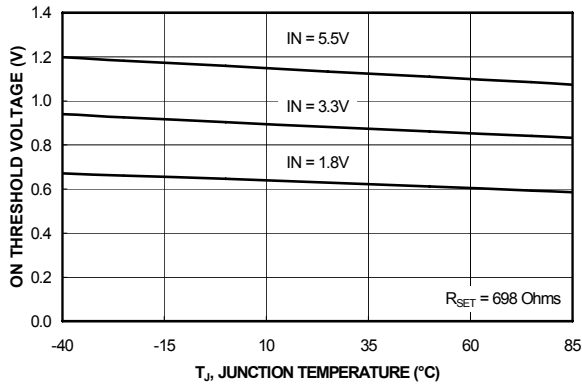

Figure 14. ON High Voltage vs. Temperature

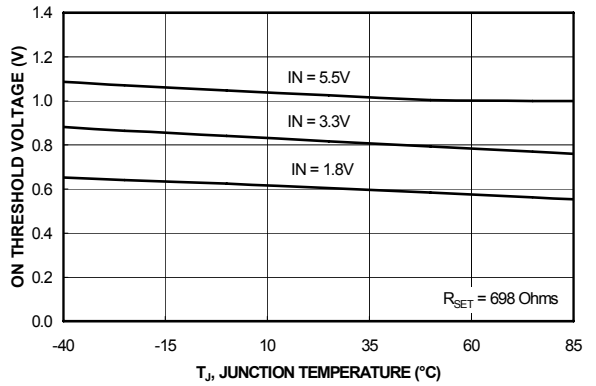

Figure 15. ON Low Voltage vs. Temperature

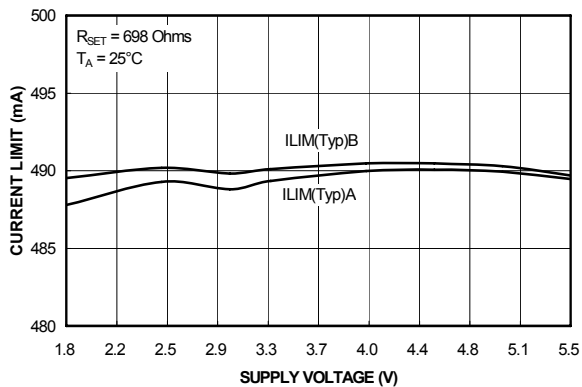

Figure 16. Current Limit vs. Supply Voltage

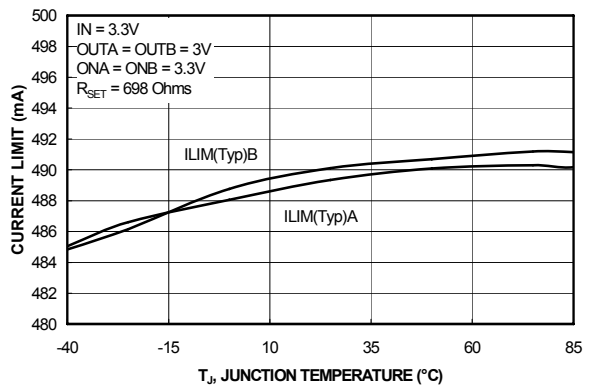

Figure 17. Current Limit vs. Temperature

### Typical Characteristics

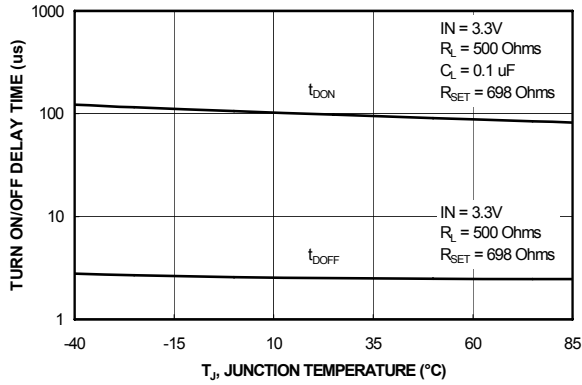

Figure 18.  $t_{DON}$  /  $t_{DOFF}$  vs. Temperature

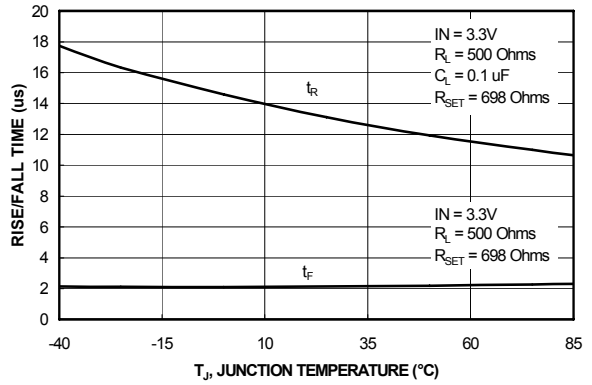

Figure 19.  $t_{RISE}$  /  $t_{FALL}$  vs. Temperature

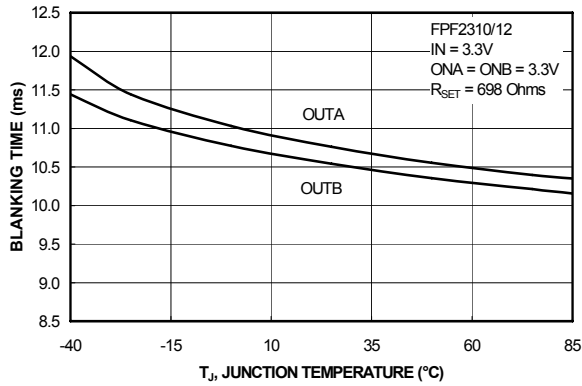

Figure 20.  $t_{BLANK}$  vs. Temperature

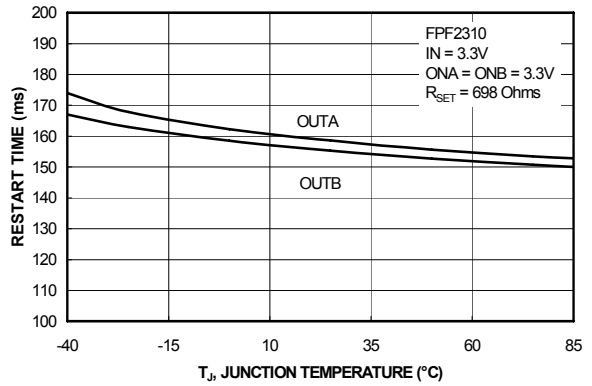

Figure 21.  $t_{RSTRT}$  vs. Temperature

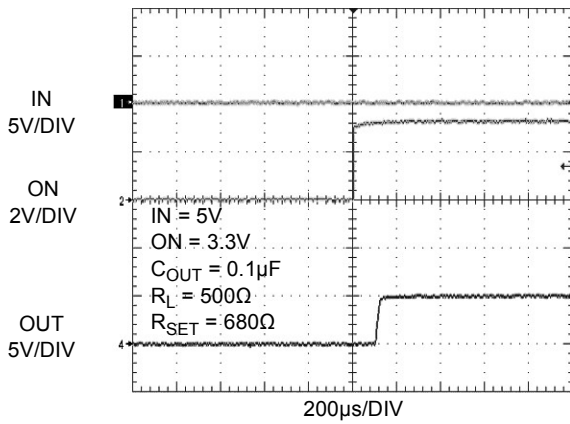

Figure 22.  $t_{ON}$  Response

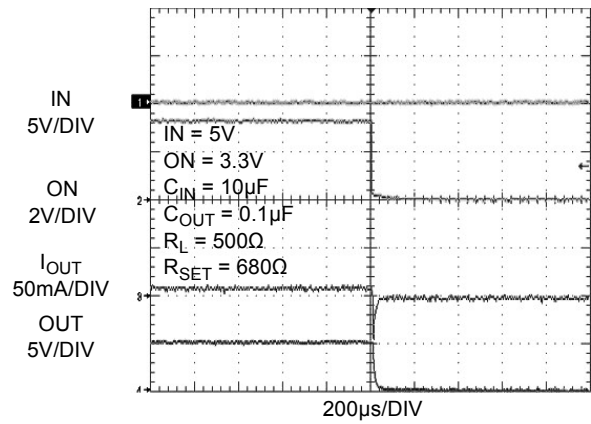

Figure 23.  $t_{OFF}$  Response

Typical Characteristics

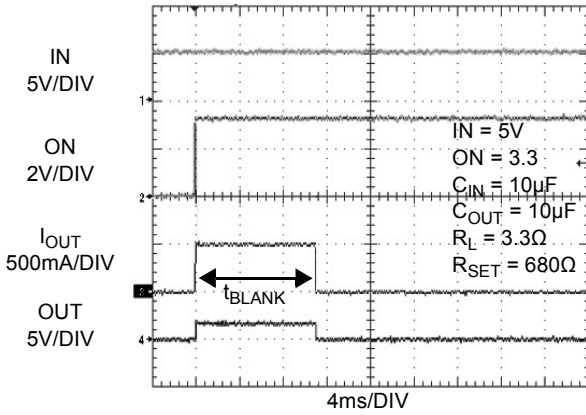

Figure 24.  $t_{BLANK}$  Response (FPF2310/12)

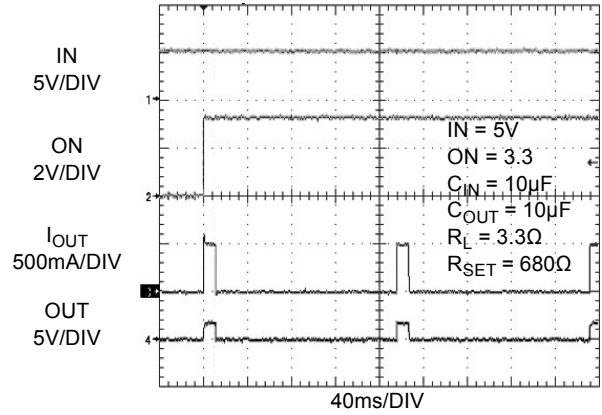

Figure 25.  $t_{RSTRT}$  Response (FPF2310)

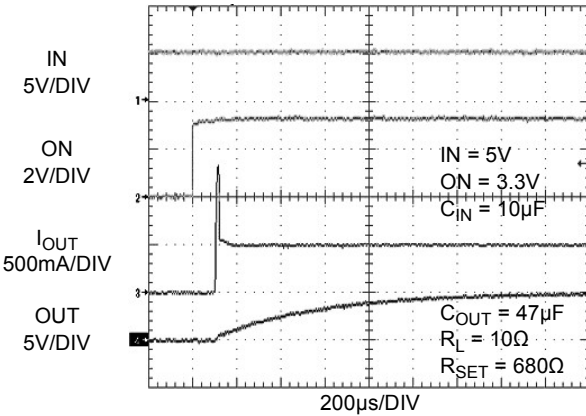

Figure 26. Current Limit Response with 47µF

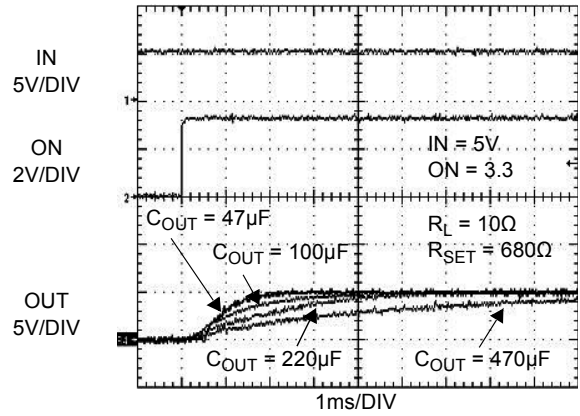

Figure 27. Output Voltage Rise Time with Various Load Capacitor

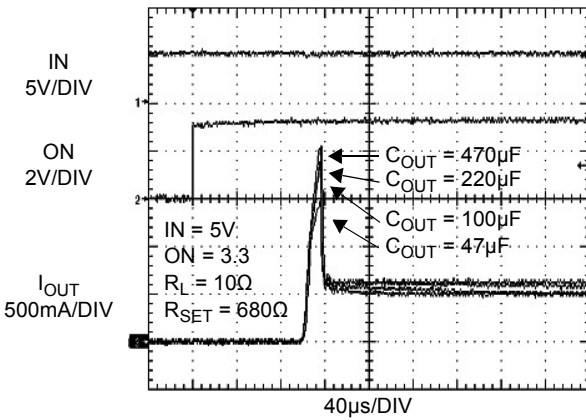

Figure 28. Output Current Inrush at Startup with Various Load Capacitors

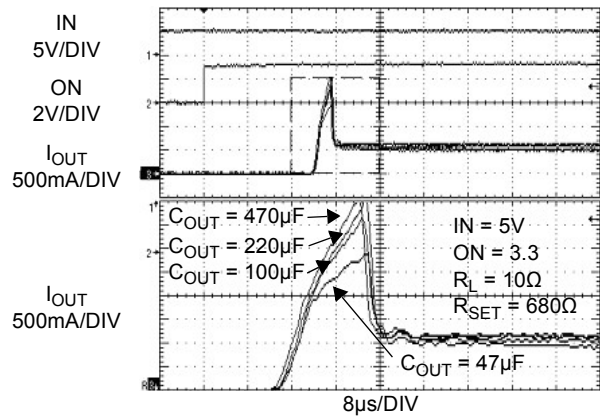

Figure 29. Output Current Inrush at Startup with Various Load Capacitors

Typical Characteristics

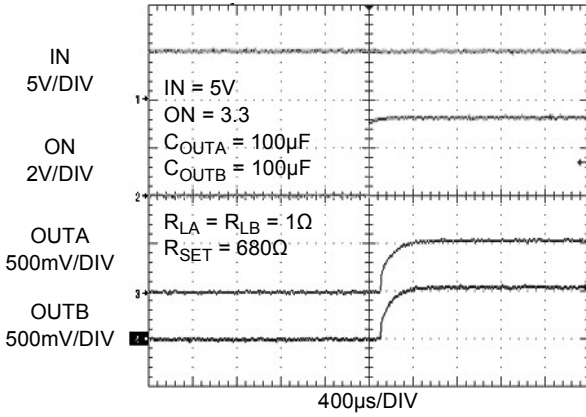

Figure 30. Current Limit Response Time Both Channels are in OC

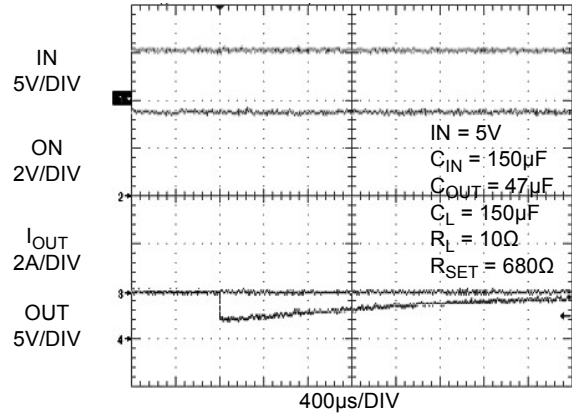

Figure 31. Inrush Response During Capacitive Load Hot Plug-In Event

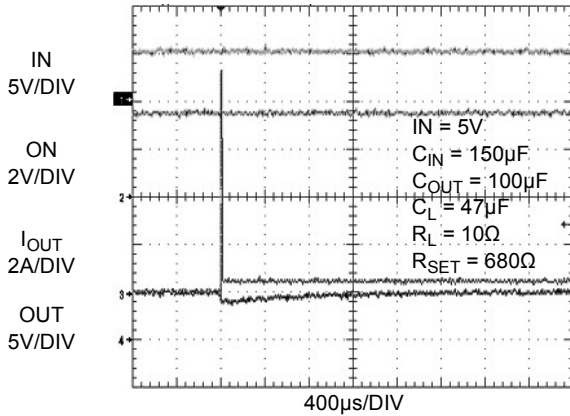

Figure 32. Inrush Response During Capacitive and Resistive Load Hot Plug-In Event

## Description of Operation

The FPF2310/2/3/3L are dual-output current-limit switches designed to meet notebook computer, peripheral USB port, and point-of-load (POL) application power requirements. Dual-output current can be used where two USB ports are powered by hosts or self-powered hubs. The FPF231X family offers control and protection while providing optimum operation current for safe design practices. The core of each switch is a 75mΩ (IN = 5.5V) P-channel MOSFET and a controller capable of functioning over an input operating range of 1.8 to 5.5V. The FPF231X offers current limiting, UVLO (under-voltage lockout), and thermal shutdown protection in each switch. In the event of an over-current condition, the load switch limits the load to current limit value. The current limit value for each switch can be adjusted through the ISET pins. 400mA-600mA is adjustable for the FPF2310 through FPF2313. The minimum current limit is 400mA-600mA with 10% accuracy at +25°C with minimum variation over temperature.

### On/Off Control

The ON pin is active HIGH for FPF2310/2/3 and controls the state of the switch. Pulling the ON pin continuous to HIGH holds the switch in ON state. The switch moves into the OFF state when the ON pin is pulled LOW or if a fault is encountered. FPF2313L is active LOW and performs in reverse order. For all versions, an under-voltage on input voltage or a junction temperature in excess of 140°C overrides the ON control to turn off the switch. In addition, excessive currents cause the switch to turn off in the FPF2310 and FPF2312 after 10ms blanking time. The FPF2310 has an auto-restart feature that automatically turns the switch ON again after 150ms. For the FPF2312, the ON pin must be toggled to turn on the switch again. The FPF2313 and FPF2313L do not turn off in response to an over-current condition, but remain operating in a constant-current mode as long as ON is enabled and the thermal shutdown or UVLO is not activated. The ON pin does not have a pull-down or pull-up resistor and should not be left floating.

### Current Limiting

The current limit ensures that the current through the switch doesn't exceed a maximum value, while not limiting at less than a minimum value. FPF231X family has dual-output load switches in one package. The current limit of each switch is adjustable through the an external resistor connected to the ISET pin. The current limit range is from 400mA to 600mA with 10% current limit tolerance.

The FPF2310 and FPF2312 have a blanking time of 10ms ( $t_{BLANK(TYP)} = 10ms$ ) during which the switch acts as a constant current source.

If the over-current condition persists beyond the blanking time, the FPF2310 latches off and shuts the switch off. If the ON pin is kept active, an auto-restart feature releases the switch and turns the switch on again after a 150ms auto-restart time ( $t_{RSTRT}$ ). If the over-current condition persists beyond the blanking time, the FPF2312 has a latch-off feature that shuts the switch off. The switch is kept off until the ON pin is toggled. The FPF2313/3L have no current-limit blanking period, so remain in a constant-current state until the ON pin of the affected switch is deactivated or the thermal shutdown turns off the switch.

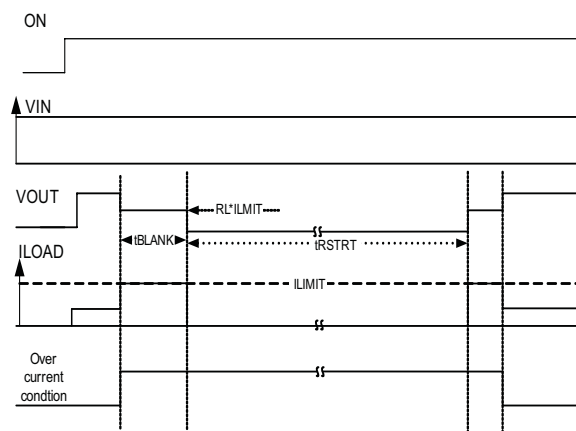

**Figure 33. FPF2310 Performance While Entering into an Over-Current Condition.**

#### Note:

- An over-current condition signal loads the output with a heavy load current larger than  $I_{LIM}$  value.

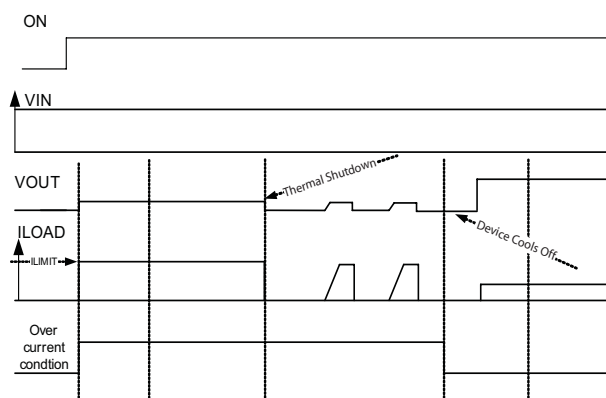

**Figure 34. FPF2313 Performance While Entering into an Over-Current Condition**

#### Note:

- An over-current condition signal loads the output with a heavy load current larger than  $I_{LIM}$  value.

**Table 1: R<sub>SET</sub> Selection Guide**

R <sub>SET</sub> [Ω]	Minimum Current Limit [mA]	Typical Current Limit [mA]	Maximum Current Limit [mA]	Tolerance (%)
511	607	674	742	10
536	578	643	707	10
562	552	613	674	10
590	526	584	642	10
620	500	556	611	10
649	478	531	584	10
681	455	506	556	10
732	424	471	518	10
775	400	445	489	10

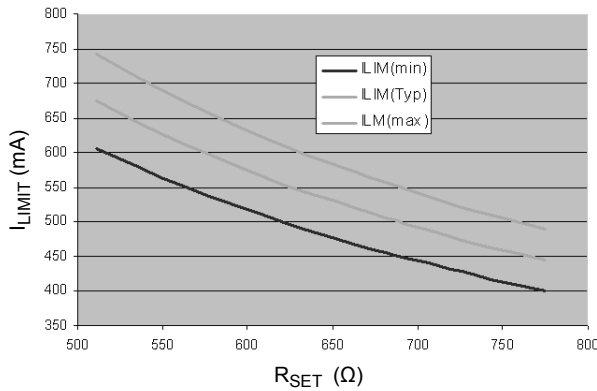

**Figure 35. I<sub>LIMIT</sub> vs. R<sub>SET</sub>**

**Under-Voltage Lockout (UVLO)**

The under-voltage lockout feature turns off the switch if the input voltage drops below the under-voltage lockout threshold. With the ON pin is active (ON pin is pulled LOW), the input voltage rising above the under-voltage lockout threshold causes a controlled turn-on of the switch and limits current overshoot. The device detects the UVLO condition when input voltage goes below UVLO voltage, but remains above 1.3V (typical).

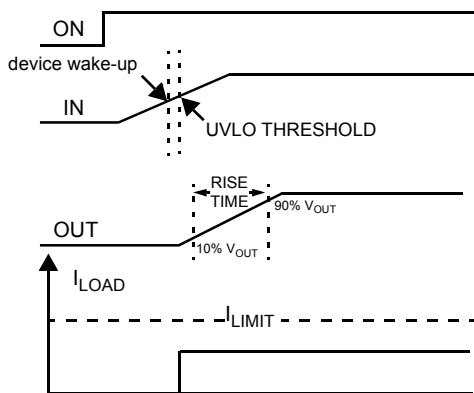

**Figure 36. Under-Voltage Lockout (UVLO)**

**Output Discharge Resistor**

The FPF2310/2/3 and FPF2313L family contains an 70Ω on-chip output pull-down resistor for quick output discharge when the switch is turned off. This features become more attractive when an application requires a large output capacitor to be discharged when switch turns off. However, the OUT pin should not be connected directly to the battery source due to the discharge mechanism of the load switch.

**Thermal Shutdown**

The thermal shutdown protects the device from internally or externally generated excessive temperatures. Each switch has an individual thermal shutdown protection function and operates independently as adjacent switch temperature increases above 140°C. If one switch is in normal operation and shutdown protection of second switch is activated, the first channel continues to operate if the affected channel's heat stays confined. The over-temperature in one channel can shut down both switches due to rapidly generated excessive load currents resulting in very high power dissipation. Generally, a thermally improved board layout can provide heat sinking and allow heat to stay confined and not affect operation of the second switch.

During an over-temperature condition, the affected switch is turned off. If the temperature of the die drops below the threshold temperature, the switch automatically turns on again. To avoid unwanted thermal oscillations, a 10°C (typical) thermal hysteresis is implemented between thermal shutdown entry and exit temperatures.

If output of both switches are connected together and an excessive load current activates thermal protection of both, the controller can shutdown the switches after both outputs go LOW and turn on both channels again. This provides a simultaneous switch turn on. Thermal protection is for device protection and should not be used as regular application operation.

## Application Information

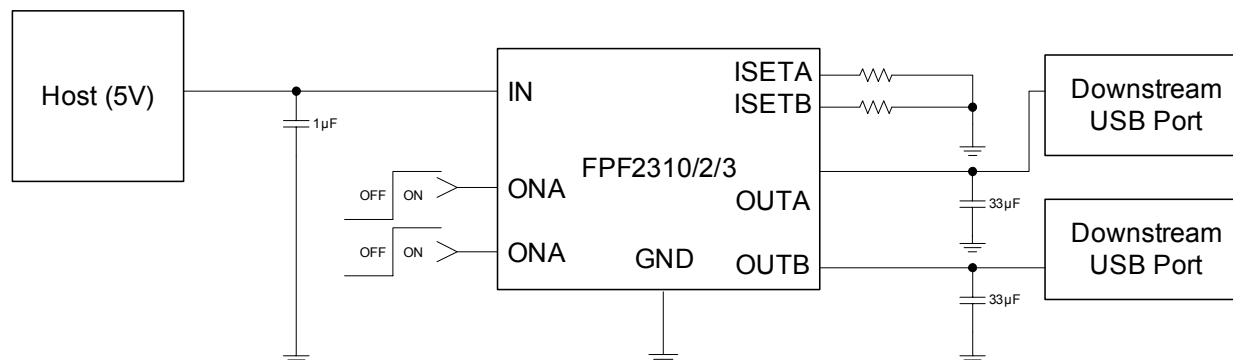

Figure 37. Typical Application

### Input Capacitor

To limit the voltage drop on the input supply caused by transient inrush currents when the switch is turned on into discharged load capacitors or a short-circuit; an input capacitor,  $C_{IN}$ , is recommended between IN and GND. The FPF2310/2/3/3L features a fast current limit response time of 20µs. An inrush current (also known as surge current) could occur during the current limit response time while the switch is responding to an over-current condition caused by large output capacitors. A 10µF ceramic capacitor,  $C_{IN}$ , is required to provide charges for the inrush current and prevent input voltage drop at the turn on. Higher values of  $C_{IN}$  to further reduce the voltage drop.

### Output Capacitor

A 0.1µF to 1µF capacitor,  $C_{OUT}$ , should be placed between the OUT and GND pins. This capacitor prevents parasitic board inductances from forcing output voltage below GND when the switch turns off. This capacitor should have a low dissipation factor. An X7R MLCC (Multilayer Ceramic Chip) capacitors is recommended.

For the FPF2310 and FPF2312, the total output capacitance needs to be kept below a maximum value,  $C_{OUT(MAX)}$ , to prevent the part from registering an over-current condition beyond the blanking time and shutdown. The maximum output capacitance for a given input voltage can be determined from the following:

$$C_{OUT(MAX)} = \frac{I_{LIM(MIN)} \times t_{BLANK(MIN)}}{V_{IN}} \quad (2)$$

For example, in a 5V application and  $I_{LIM(MIN)} = 500\text{mA}$  using  $R_{SET} = 620\Omega$ ,  $C_{OUT(MAX)}$  can be determined as:

$$C_{OUT(MAX)(IN=5V)} = \frac{0.5\text{A} \times 5\text{ms}}{5} \quad (3)$$

$$= 500\mu\text{F}$$

### Power Dissipation

During normal operation as a switch, the power dissipation of device is small and has little effect on the operating temperature of the part. The maximum power dissipation for both switches, while the switch is in normal operation, occurs just before both channels enter into current limit. This may be calculated using:

$$P_{D\_MAX(NormalOperation)} = 2 \times (I_{LIM(MIN)})^2 \times R_{ON(MAX)} \quad (4)$$

For example, for a 5V application maximum normal operation power loss while both switches delivering output current up to 500mA ( $I_{LIM(MIN)} = 500\text{mA}$ ) can be calculated as:

$$P_{D\_MAX(NormalOperation)(IN=5V)} = 2 \times (0.5)^2 \times 0.14 \quad (5)$$

$$= 70\text{mW}$$

The maximum junction temperature should be limited to 125°C under normal operation. Junction temperature can be calculated using:

$$T_J = P_D \times R_{\theta JA} + T_A \quad (6)$$

where:

$T_J$  is junction temperature;  
 $P_D$  is power dissipation across the switch  
 $R_{\theta JA}$  is thermal resistance, junction-to-ambient; and  $T_A$  is ambient temperature

For example,  $T_{J(MAX)(Normal\ operation)}$  for an MLP 3x3mm package with  $T_A=25^\circ\text{C}$  while both switches are delivering up to 1.1A, is calculated as:

$$T_{J(MAX)(NormalOperation)} = P_{D\_MAX(Normal\ Operation)(IN=5V)} \times 216 + 25$$

$$= 40.12^\circ\text{C} \quad (7)$$



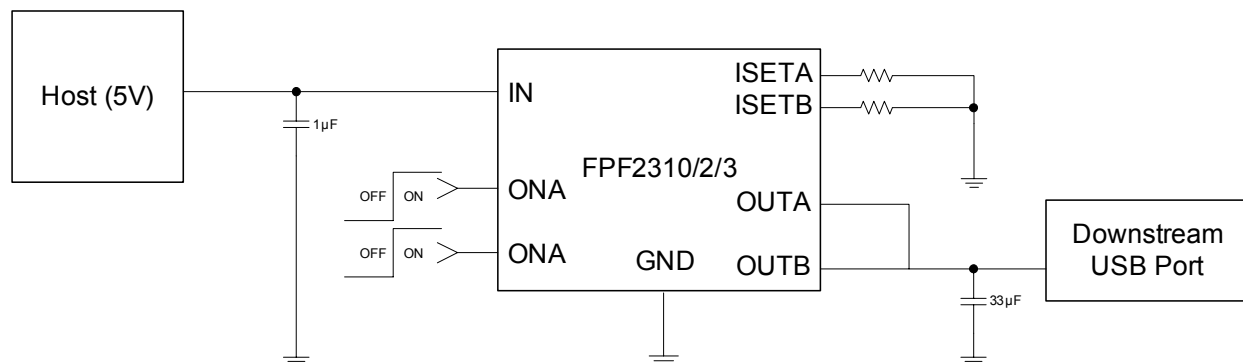

Figure 38. Self-Power USB for High Current Demand

If the part goes into current limit, the maximum power dissipation occurs when the output of switch is shorted to ground. For the FPF2310, the power dissipation scales with the auto-restart time,  $t_{RSTRT}$ , and the over-current blanking time,  $t_{BLANK}$ . In this case, the maximum power dissipated for the FPF2310 is:

$$P_{D\_MAX(CurrentLimit)} = 2 \times \frac{t_{BLANK}}{t_{BLANK} + t_{RSTRT}} \times I_{N(MAX)} \times I_{LIM(MAX)} \quad (8)$$

Which results in:

$$P_{D\_MAX(CurrentLimit)} = 2 \times \frac{10}{10 + 150} \times 5.5 \times 0.74 = 508\text{mW} \quad (9)$$

Note that this is below the maximum package power dissipation and the thermal shutdown feature protection provides additional safety to protect the part from damage due to excessive heating. The junction temperature is only able to increase to the thermal shutdown threshold. Once this temperature has been reached, toggling ON has no effect until the junction temperature drops below the thermal shutdown exit temperature. For the FPF2313 and FPF2313L, a short on the both outputs causes both switches to operate in a constant-current state and dissipating a worst-case power of:

$$P_{MAX} = I_{N(MAX)} \times I_{LIM(MAX)} = 2 \times 5.5 \times 0.74 = 8.14\text{W} \quad (10)$$

As both FPF2313/3L outputs are connected to GND.

This power dissipation is significant and activates both thermal shutdown blocks. The part cycles in and out of thermal shutdown as long as the ON pin is activated (pulled LOW) and the output short is present.

If high current of over 1A is required to supply enough power to a downstream function, dual outputs can be tied together as shown in Figure 38.

## PCB Layout Recommendations

For the best performance, all traces should be as short as possible. To be most effective, the input and output capacitors should be placed close to the device to minimize the effects that parasitic trace inductances may have on normal and short-circuit operation. Using wide traces for IN, OUTs, and GND pins helps minimize parasitic electrical effects along with minimizing the case-to-ambient thermal impedance.

## Improving Thermal Performance of the FPF231X Family of Devices

Improper layout could result in higher junction temperature and triggering the thermal shutdown protection feature. This concern applies particularly to the FPF2313 and FPF2313L, where both channels operate in constant-current mode in the overload conditions and; during fault condition, the outputs are shorted, resulting to large voltage drop across switches. In this case, power dissipation of the switch ( $P_D = (V_{IN} - V_{OUT}) \times I_{LIM(MAX)}$ ) could exceed the maximum absolute power dissipation of part.

The following techniques improve the thermal performance of this family of devices. These techniques are listed in order of the significance of impact.

1. Thermal performance of the load switch can be improved by connecting the DAP (Die Attach Pad) of MLP 3x3mm package to the GND plane of the PCB.
2. Embedding two exposed through-hole vias into the DAP (pin 9) provides a path for heat to transfer to the back GND plane of the PCB. A drill size of round, 15 mils (0.4mm) with 1-ounce copper plating is recommended to create appropriate solder reflow. A smaller size hole prevents the solder from penetrating into the via, resulting in device lift-up. Similarly, a larger via-hole consumes excessive solder and may result in voiding the DAP.

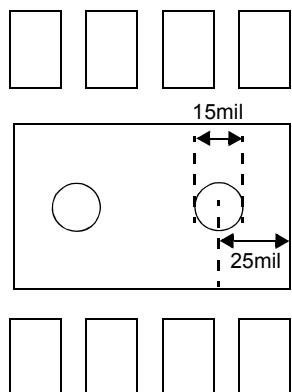

**Figure 39. Two Through-Hole Open Vias Embedded in DAP**

3. The IN, OUTs, and GND pins dissipate most of the heat generated during a high-load current condition. The layout suggested in Figure 39 illustrates a proper layout for devices in MLP 3x3mm packages. IN, OUTs, and GND pins are connected to adequate copper so that heat may be transferred as efficiently as possible out of the device. The low-power FLAGB and ON pins' traces may be laid-out diagonally from the device to maximize the area available to the ground pad. Placing the input and output capacitors as close to the device as possible also contributes to heat dissipation, particularly during high load currents.

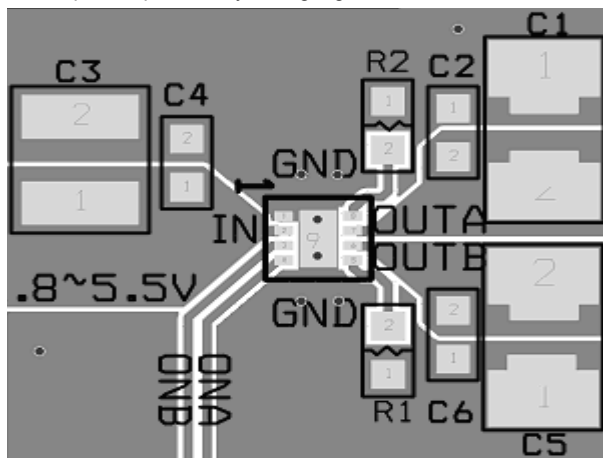

**Figure 40. Proper Layout of Output and Ground Copper Area**

### FPF231X Evaluation Board

FPF231X evaluation board has components and circuitry to demonstrate FPF2310/2/3/3L load switches functions and features accommodating both MLP 3x3mm packages. The state of the each channel can be configured using J1 and J2 jumpers. In addition, both channels can be controlled by ONA and ONB test pins. Thermal performance of the board is improved using techniques recommended in the layout recommendations section. R3 and R4 resistors are used on the board to sink a light load current when switches are activated.

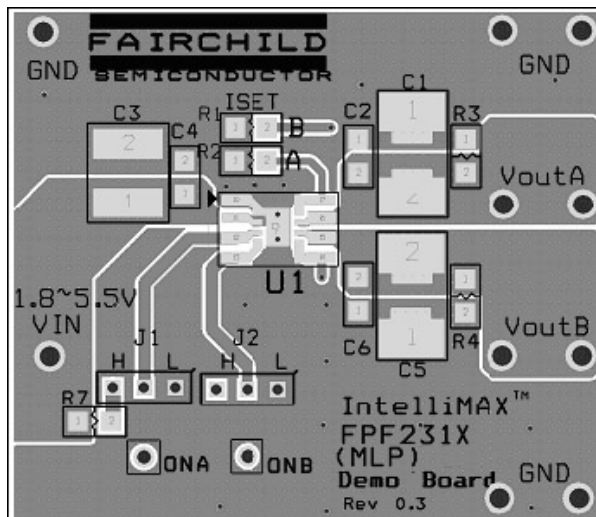

**Figure 41. Top, SST, and AST Layers (MLP 3x3mm Package)**

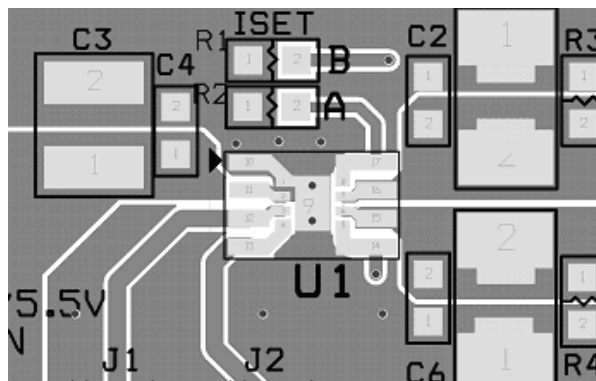

**Figure 42. Zoom In to Top Layer**

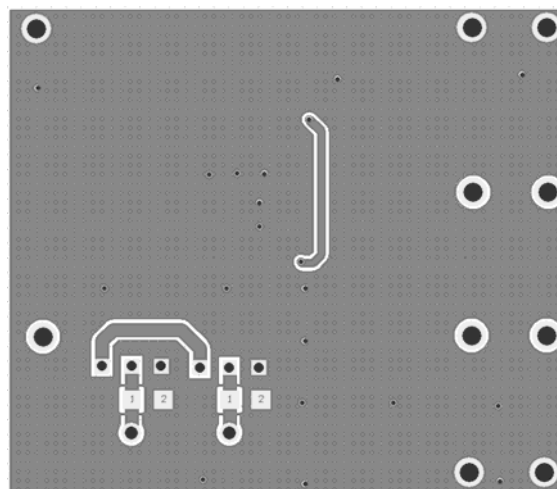

**Figure 43. Bottom and ASB Layers**

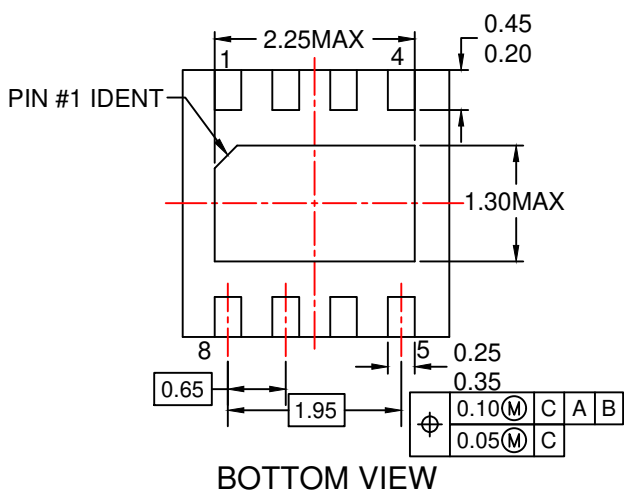
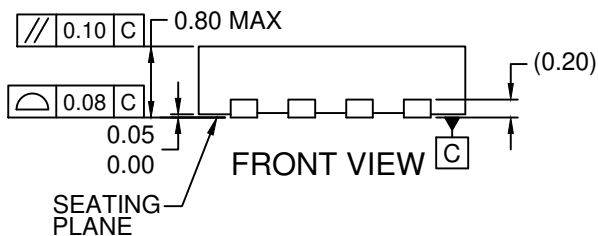
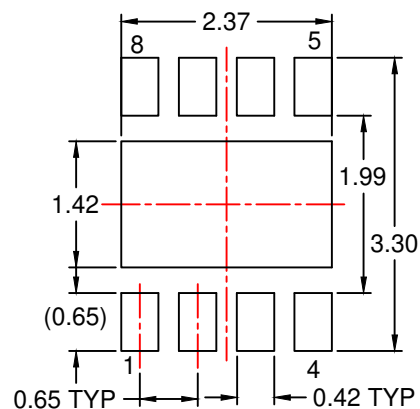
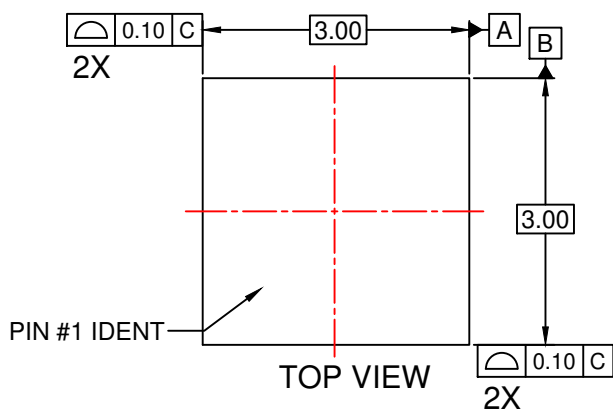

**NOTES:**

- A. CONFORMS TO JEDEC REGISTRATION MO-229, VARIATION VEEC, DATED 11/2001.
- B. DIMENSIONS ARE IN MILLIMETERS.
- C. DIMENSIONS AND TOLERANCES PER ASME Y14.5M, 2009.
- D. LAND PATTERN RECOMMENDATION IS EXISTING INDUSTRY LAND PATTERN.
- E. DRAWING FILENAME: MKT-MLP08Drev3



ON Semiconductor and  are trademarks of Semiconductor Components Industries, LLC dba ON Semiconductor or its subsidiaries in the United States and/or other countries. ON Semiconductor owns the rights to a number of patents, trademarks, copyrights, trade secrets, and other intellectual property. A listing of ON Semiconductor's product/patent coverage may be accessed at [www.onsemi.com/site/pdf/Patent-Marking.pdf](http://www.onsemi.com/site/pdf/Patent-Marking.pdf). ON Semiconductor reserves the right to make changes without further notice to any products herein. ON Semiconductor makes no warranty, representation or guarantee regarding the suitability of its products for any particular purpose, nor does ON Semiconductor assume any liability arising out of the application or use of any product or circuit, and specifically disclaims any and all liability, including without limitation special, consequential or incidental damages. Buyer is responsible for its products and applications using ON Semiconductor products, including compliance with all laws, regulations and safety requirements or standards, regardless of any support or applications information provided by ON Semiconductor. "Typical" parameters which may be provided in ON Semiconductor data sheets and/or specifications can and do vary in different applications and actual performance may vary over time. All operating parameters, including "Typicals" must be validated for each customer application by customer's technical experts. ON Semiconductor does not convey any license under its patent rights nor the rights of others. ON Semiconductor products are not designed, intended, or authorized for use as a critical component in life support systems or any FDA Class 3 medical devices or medical devices with a same or similar classification in a foreign jurisdiction or any devices intended for implantation in the human body. Should Buyer purchase or use ON Semiconductor products for any such unintended or unauthorized application, Buyer shall indemnify and hold ON Semiconductor and its officers, employees, subsidiaries, affiliates, and distributors harmless against all claims, costs, damages, and expenses, and reasonable attorney fees arising out of, directly or indirectly, any claim of personal injury or death associated with such unintended or unauthorized use, even if such claim alleges that ON Semiconductor was negligent regarding the design or manufacture of the part. ON Semiconductor is an Equal Opportunity/Affirmative Action Employer. This literature is subject to all applicable copyright laws and is not for resale in any manner.

## PUBLICATION ORDERING INFORMATION

### LITERATURE FULFILLMENT:

Literature Distribution Center for ON Semiconductor  
19521 E. 32nd Pkwy, Aurora, Colorado 80011 USA  
**Phone:** 303-675-2175 or 800-344-3860 Toll Free USA/Canada  
**Fax:** 303-675-2176 or 800-344-3867 Toll Free USA/Canada  
**Email:** [orderlit@onsemi.com](mailto:orderlit@onsemi.com)

**N. American Technical Support:** 800-282-9855 Toll Free  
USA/Canada  
**Europe, Middle East and Africa Technical Support:**  
Phone: 421 33 790 2910  
**Japan Customer Focus Center**  
Phone: 81-3-5817-1050

**ON Semiconductor Website:** [www.onsemi.com](http://www.onsemi.com)  
**Order Literature:** <http://www.onsemi.com/orderlit>  
For additional information, please contact your local  
Sales Representative