



Chipsmall Limited consists of a professional team with an average of over 10 year of expertise in the distribution of electronic components. Based in Hongkong, we have already established firm and mutual-benefit business relationships with customers from,Europe,America and south Asia,supplying obsolete and hard-to-find components to meet their specific needs.

With the principle of “Quality Parts,Customers Priority,Honest Operation,and Considerate Service”,our business mainly focus on the distribution of electronic components. Line cards we deal with include Microchip,ALPS,ROHM,Xilinx,Pulse,ON,Everlight and Freescale. Main products comprise IC,Modules,Potentiometer,IC Socket,Relay,Connector.Our parts cover such applications as commercial,industrial, and automotives areas.

We are looking forward to setting up business relationship with you and hope to provide you with the best service and solution. Let us make a better world for our industry!



Contact us

Tel: +86-755-8981 8866 Fax: +86-755-8427 6832

Email & Skype: info@chipsmall.com Web: www.chipsmall.com

Address: A1208, Overseas Decoration Building, #122 Zhenhua RD., Futian, Shenzhen, China



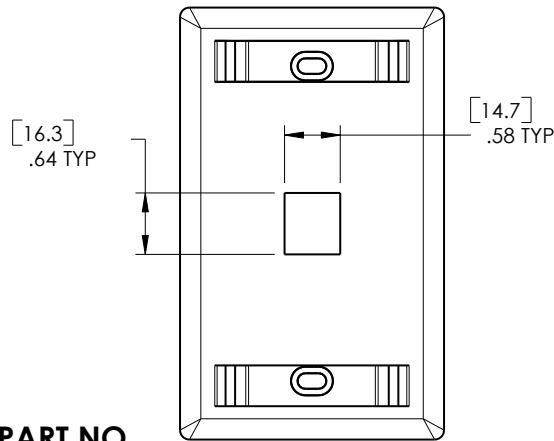

PART NO. FPISINGLE-__

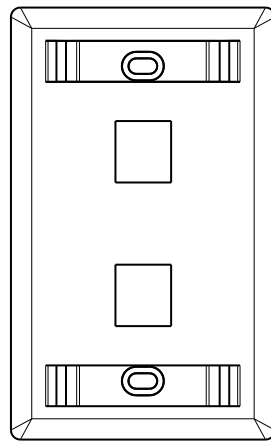
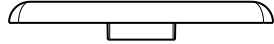

PART NO. FPIDUAL-__

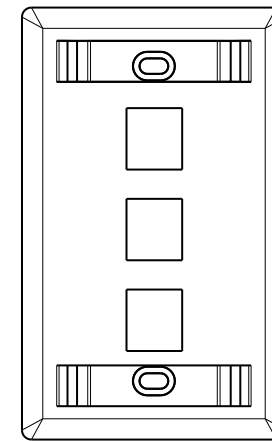
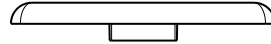

PART NO. FPITRIPLE-__

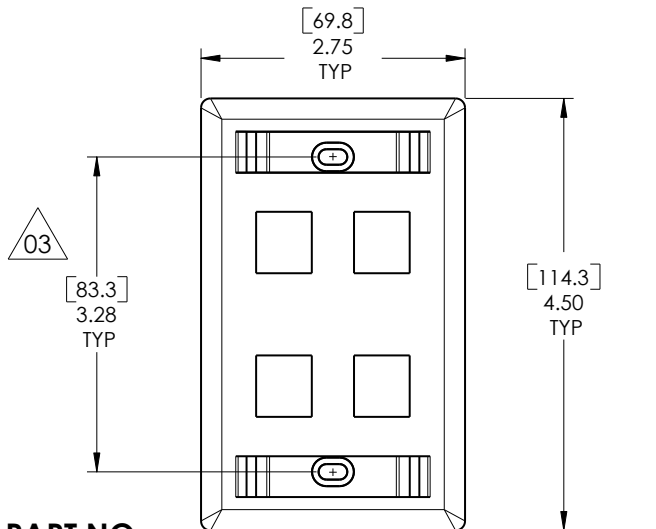
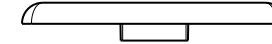

PART NO. FPIQUAD-__

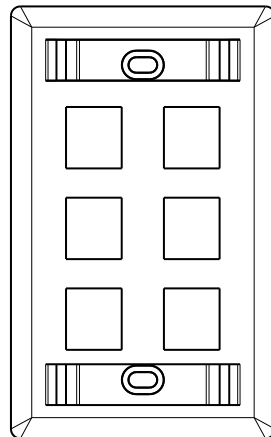
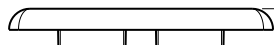

PART NO. FPISIX-__

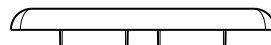

[5.6] .22 TYP

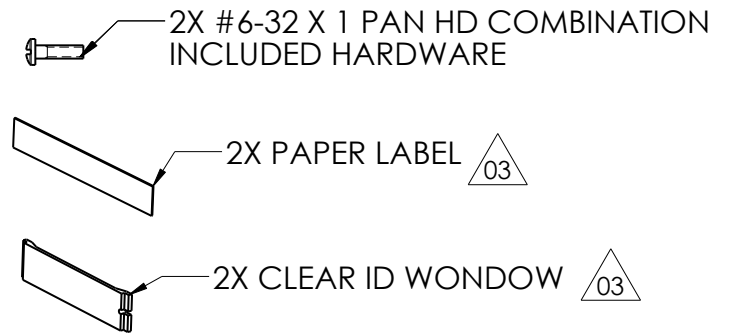

PRODUCT CODE DESCRIPTION

FPISINGLE -
COLOR

I = IVORY FW = OFFICE WHITE
W = WHITE BK = BLACK
GRY = GRAY B = BROWN

INVENTORS

HellermannTyton

ALL PROPRIETARY RIGHTS IN THE SUBJECT MATTER SHOWN ON THIS DRAWING ARE EXCLUSIVE PROPERTY OF HELLERMANN TYTON

name	date	city, state

REVISION

level	03
by	KAC
date	04/17/2006
ECN #	010402
part level	-

DIMENSIONS

TOLERANCES	.XXXX = [±.013]/±.0005
	.XXX = [±.13]/±.005
	.XX = [±.3]/±.01
	.X = [±.8]/±.03
	∠ = ±0.5°
	unless otherwise specified
units	[millimeters]/inches

PART

number	SEE ABOVE	phase	Pre-Production
name	FPI ID FACEPLATES		
material	PVC UL94V-0		

DRAWING

format	AH	CAD	SW 2006	scale	1:2
computer file name	MI3013002CST_03		previous drawing number		
drawn	MEF	checked	K.A.C.	approved	
	12/14/2004		04/17/2006		
type	Customer	sheet 1 of 1			
number	MI3013002CST				