



Chipsmall Limited consists of a professional team with an average of over 10 year of expertise in the distribution of electronic components. Based in Hongkong, we have already established firm and mutual-benefit business relationships with customers from,Europe,America and south Asia,supplying obsolete and hard-to-find components to meet their specific needs.

With the principle of "Quality Parts,Customers Priority,Honest Operation,and Considerate Service",our business mainly focus on the distribution of electronic components. Line cards we deal with include Microchip,ALPS,ROHM,Xilinx,Pulse,ON,Everlight and Freescale. Main products comprise IC,Modules,Potentiometer,IC Socket,Relay,Connector.Our parts cover such applications as commercial,industrial, and automotives areas.

We are looking forward to setting up business relationship with you and hope to provide you with the best service and solution. Let us make a better world for our industry!



## Contact us

Tel: +86-755-8981 8866 Fax: +86-755-8427 6832

Email & Skype: info@chipsmall.com Web: www.chipsmall.com



Address: A1208, Overseas Decoration Building, #122 Zhenhua RD., Futian, Shenzhen, China



# PSE Technology Corporation

## SPECIFICATION FOR APPROVAL

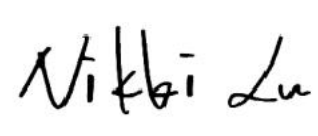
CUSTOMER	_____
NOMINAL FREQUENCY	<b>24.000000 MHz</b>
PRODUCT TYPE	<b>TYPE FQ 3.2x2.5 GLASS SEALED CRYSTAL</b>
PART NUMBER	<b>FQ2400005</b>
CUSTOMER P/N	_____
ISSUE DATE	<b>November 27, 2012</b>
VERSION	<b>A</b>

APPROVED	PREPARED	QA
		
APPROVED BY CUSTOMER		
Please return one copy with approval to PSE-TW		

### PSE Technology Corporation

No.2, Tzu-Chiang 5th Rd., Chung Li Industrial Park,  
 Chung Li City, Taoyuan County, Taiwan (R.O.C.)  
 TEL:886-3-451-8888  
 FAX:886-3-461-3865  
<http://www.saronix-ecera.com.tw/>

- \*RoHS Exemption
- \*HF-Halogen Free
- \*REACH Compliant

**A Company of PERICOM Semiconductor Corporation**

# TYPE FQ 3.2x2.5 GLASS SEALED CRYSTAL

**FQ2400005**

VER.A 27-NOV-12

## VERSION HISTORY

Version No.	Version Date	Customer Receipt Date	Supplier Receipt Date	Description	Notes
A	Nov. 27, 2012			Initial Release	

# TYPE FQ 3.2x2.5 GLASS SEALED CRYSTAL

**FQ2400005**

VER.A 27-NOV-12

## ELECTRICAL SPECIFICATIONS

Item	Symbol	Specifications	Units	Notes
Nominal Frequency	Fn	24.000000	MHz	
Mode of Oscillation	MO	AT Cut-Fundamental		
Calibration Load Capacitance	CL	18	pF	
Calibration Tolerance	FL	± 20	ppm	at 25°C±3°C
Operating Temperature Range	TR	-40 to +85	°C	
Frequency Stability(Frequency Deviation over the Operating Temperature Range)	F/T	± 30	ppm	Reference to the Frequency at 25°C
Operating Drive Level		10	μW	
Maximum Drive Level		100	μW	
Equivalent Series Resistance	ESR	60	Ω	Max.
Shunt Capacitance	C0	5	pF	Max.
Aging at 25°C		± 3	ppm	Max, 1st year
Storage Temperature		-55 to +125	°C	
Insulation Resistance		500	MΩ	Min



# TYPE FQ 3.2x2.5 GLASS SEALED CRYSTAL

**FQ2400005**

VER.A 27-NOV-12

## RELIABILITY SPECIFICATIONS

### MECHANICAL AND ENVIRONMENTAL RATINGS:

- a) FINE LEAK TEST: JESD22-A109 (Condition 1A)
- b) GROSS LEAK TEST: JESD22-A109 (Condition C)
- c) MOISTURE RESISTANCE: JESD22-A113
- d) SHOCK: JESD22-B104 (Condition B)
- e) SOLDERABILITY : (RoHS version): J-STD-002
- f) VIBRATION: JESD22-B103
- g) SOLVENT RESISTANCE: JESD22-B107
- h) RESISTANCE TO SOLDERING HEAT (RoHS version): J-STD-020D Table 5.2 Pb free devices (3 cycles max)

## SUGGESTED IR REFLOW PROFILE

\*As per IPC-JEDEC J-STD-020D

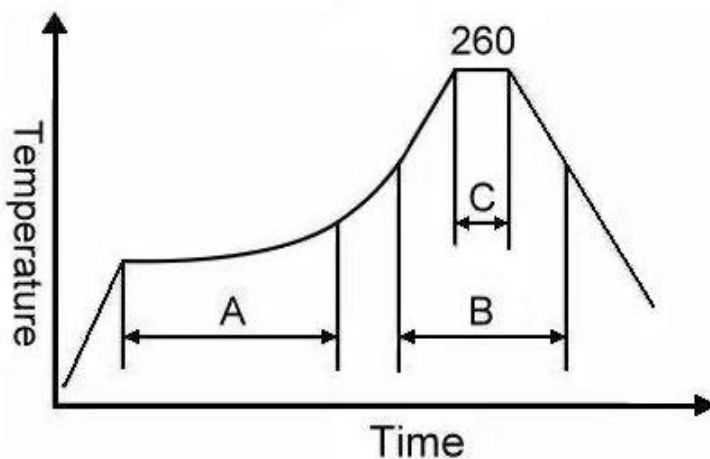

Note:

	Stage	Temperature	Time
A	Preheat	150~200°C	60~120 Sec
B	Primary Heat	217°C	60~150 Sec
C	Peak	260°C	10 Sec

For soldering reflow profile and reliability test ratings go to: <http://www.pericom.com/pdf/sre/reflow.pdf>

# TYPE FQ 3.2x2.5 GLASS SEALED CRYSTAL

**FQ2400005**

VER.A 27-NOV-12

## MARKING

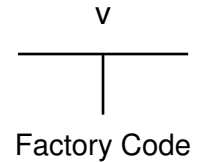
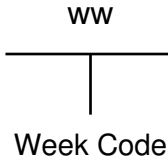
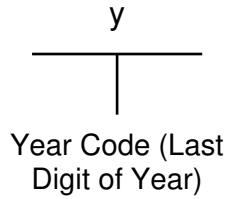

## MECHANICAL DRAWINGS ( Scale: None. Dimensions are in mm.)

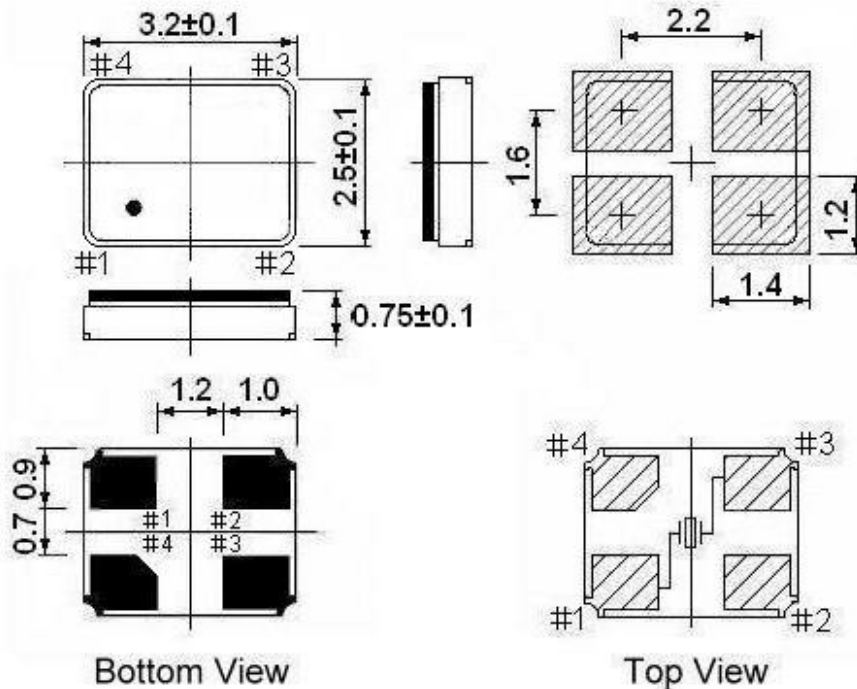

\*\* Recommended - Pin 1 & 3 : CRYSTAL  
Pin 2 & 4 : GND

### Note:

1. The marking dot denotes Pin#1.
2. Pin positions of the drawing is only for reference, and the Pin with chamfer is based on the real product.

# TYPE FQ 3.2x2.5 GLASS SEALED CRYSTAL

**FQ2400005**

VER.A 27-NOV-12

## Tape & Reel

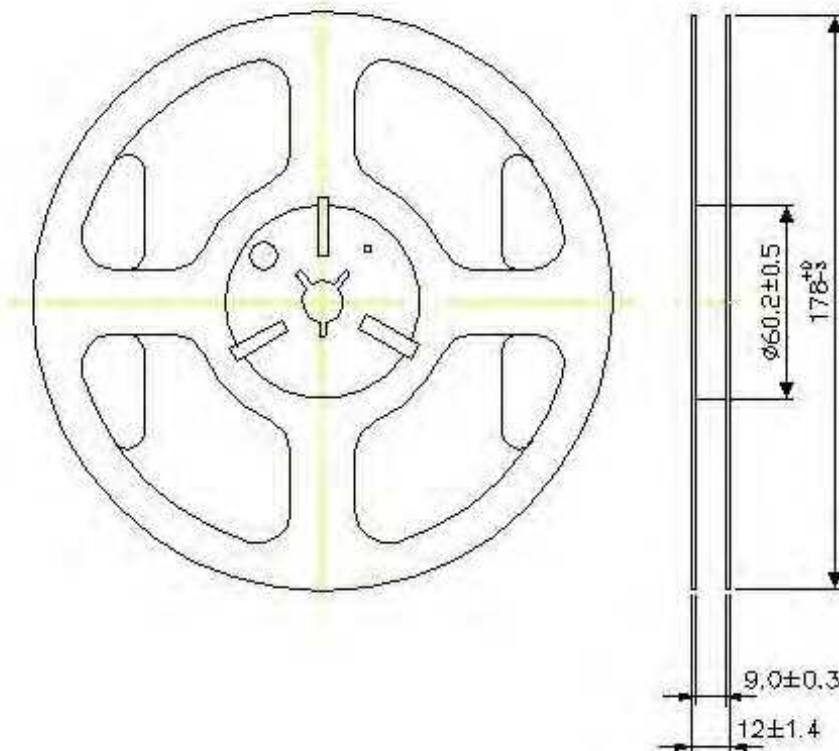
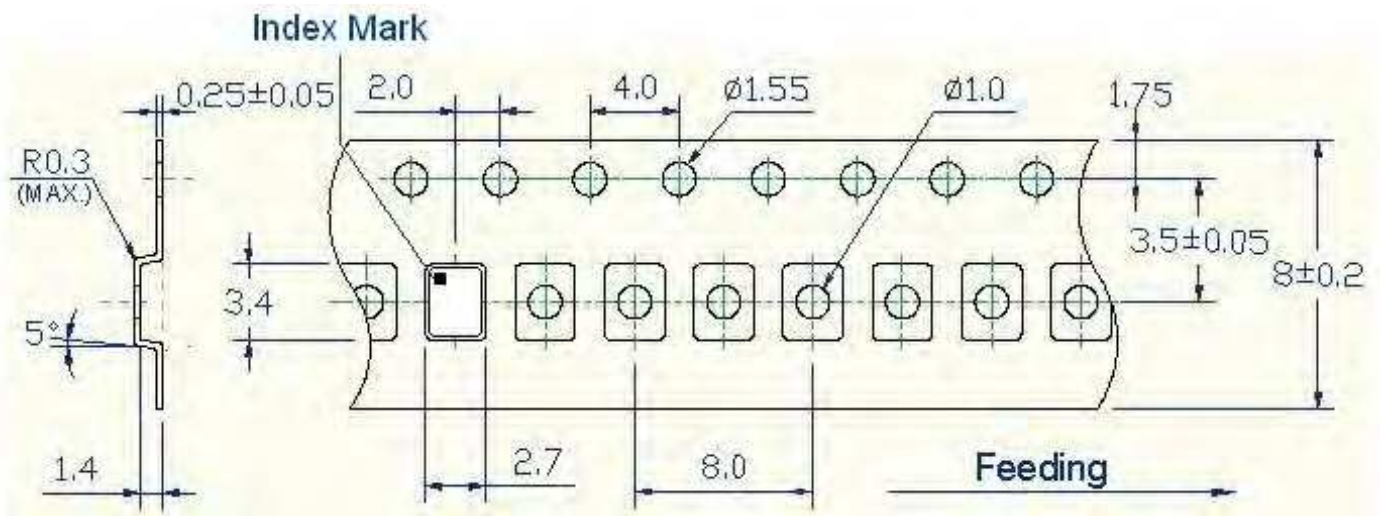

1. 230mm minimum leader which consist of carrier and/or tape followed by a minimum of 160mm of empty carrier tape sealed with cover tape.
2. 160mm minimum trailer of empty carrier tape sealed with cover tape.

# TYPE FQ 3.2x2.5 GLASS SEALED CRYSTAL

**FQ2400005**

VER.A 27-NOV-12

## PACKING

