



Chipsmall Limited consists of a professional team with an average of over 10 year of expertise in the distribution of electronic components. Based in Hongkong, we have already established firm and mutual-benefit business relationships with customers from,Europe,America and south Asia,supplying obsolete and hard-to-find components to meet their specific needs.

With the principle of “Quality Parts,Customers Priority,Honest Operation,and Considerate Service”,our business mainly focus on the distribution of electronic components. Line cards we deal with include Microchip,ALPS,ROHM,Xilinx,Pulse,ON,Everlight and Freescale. Main products comprise IC,Modules,Potentiometer,IC Socket,Relay,Connector.Our parts cover such applications as commercial,industrial, and automotives areas.

We are looking forward to setting up business relationship with you and hope to provide you with the best service and solution. Let us make a better world for our industry!



## Contact us

Tel: +86-755-8981 8866 Fax: +86-755-8427 6832

Email & Skype: info@chipsmall.com Web: www.chipsmall.com

Address: A1208, Overseas Decoration Building, #122 Zhenhua RD., Futian, Shenzhen, China





# FIBERRUNNER 6x4 Cable Routing System with **QUIKLOCK** Coupler

Part Numbers: FRH456X4, FRH456SC6, FRRA6X4, FRRASC6, FRT6X4, FRTSC6, FRFWC6X4, FRFWCSC6, FRIV456X4, FRIVRA6X4, FROV456X4, FROV456SC6, FROVRA6X4, FROVRASC6, FR6X4, FR6CR6, FRBC6X4, FRHC6, FRSHC6

## INSTALLATION INSTRUCTIONS

© Panduit Corp. 2000

Printed in U.S.A.

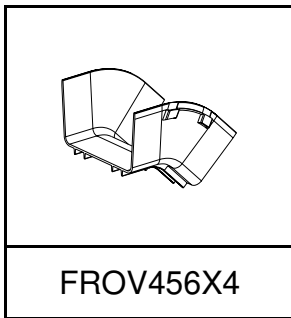
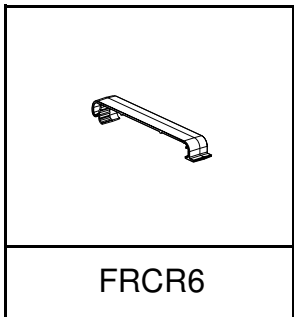
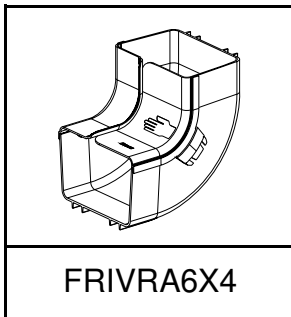
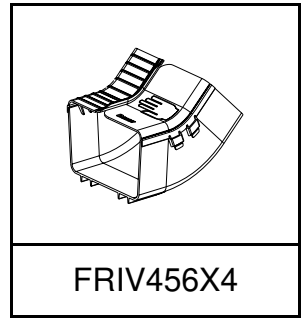
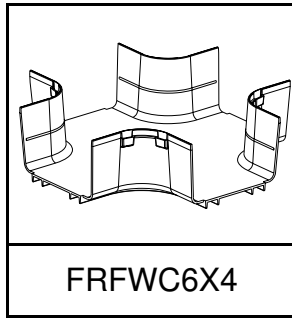
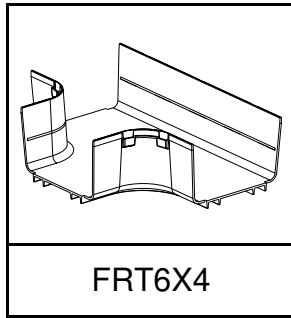
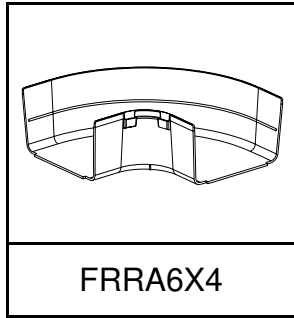
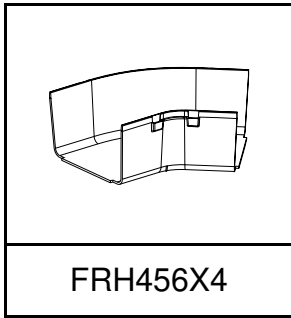

### FIBERRUNNER 6x4 Cable Retainer Installation Instructions

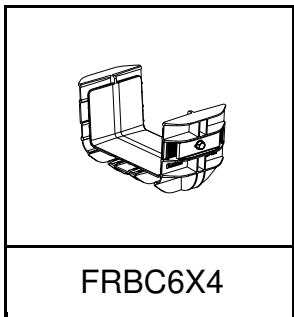
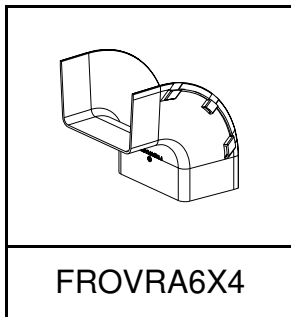
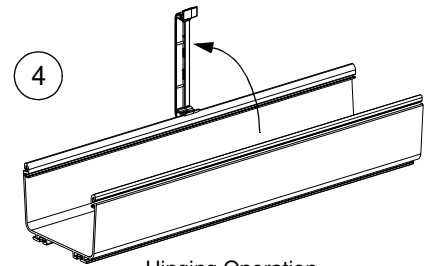
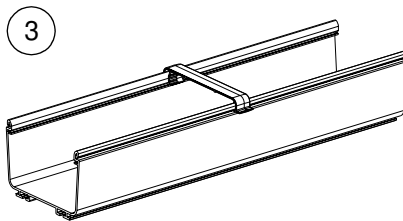
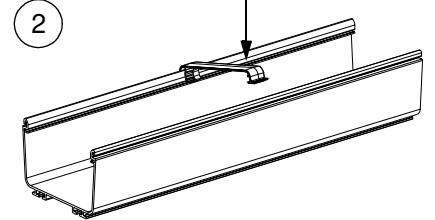
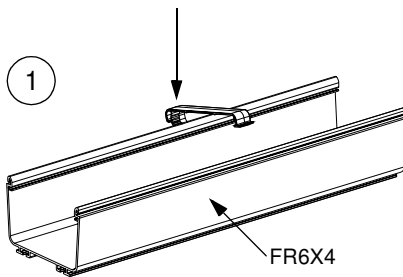

### FIBERRUNNER 6x4 QUIKLOCK Coupler Installation Instructions

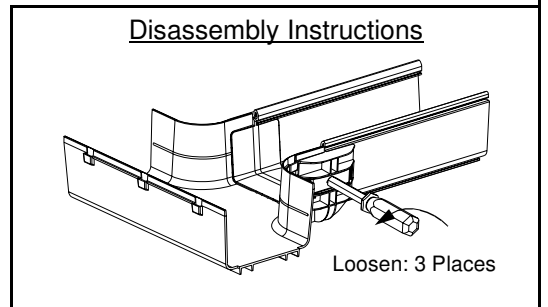
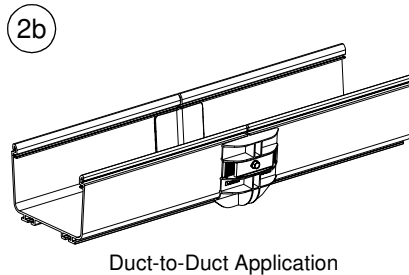
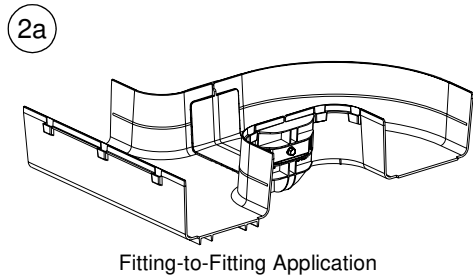
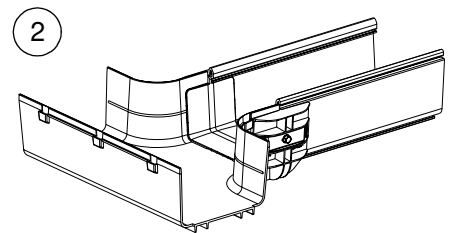
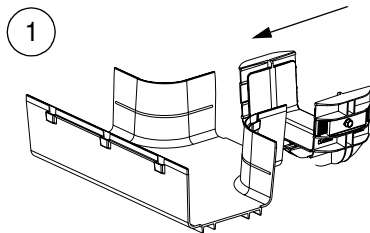

For Technical Assistance, Call: 866-405-6656

# INSTALLATION INSTRUCTIONS

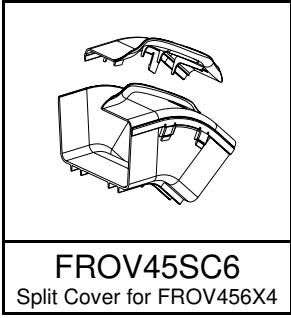
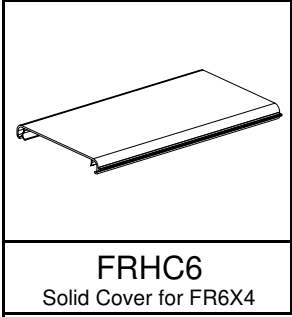
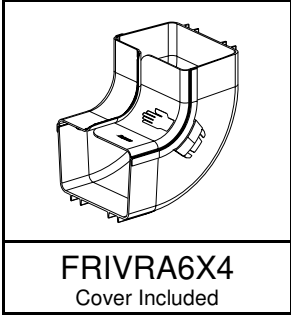
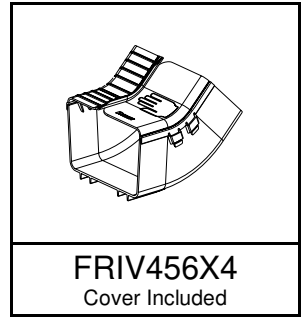
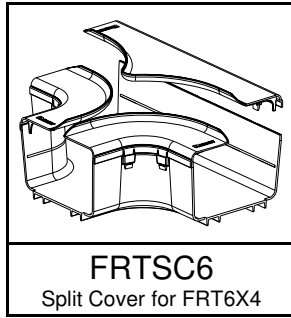
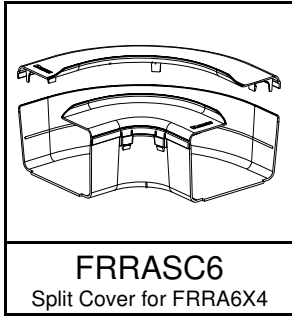
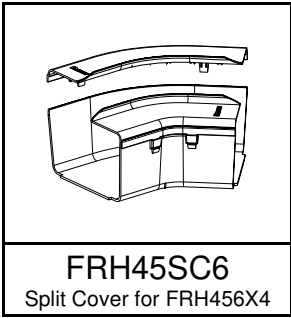

### FIBERRUNNER 6x4 Hinged Cover Installation Instructions

1

2

3

4

Hinging Operation

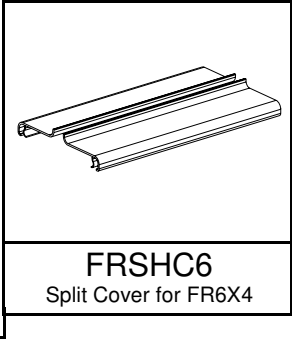
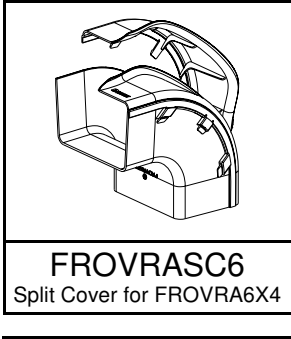

### FIBERRUNNER 6x4 Split Hinged Cover Installation Instructions

1

2

3

4

5

Hinging Operation

Instruction Sheet RW112B

## WORLDWIDE SUBSIDIARIES AND SALES OFFICES

17301 Ridgeland Avenue  
Tinley Park, IL 60477-3901  
Web Site: [www.panduit.com/ngc](http://www.panduit.com/ngc)



Fax: 866-449-1702  
Technical Support: 866-405-6656  
E-mail: [netconnsupport@panduit.com](mailto:netconnsupport@panduit.com)