



Chipsmall Limited consists of a professional team with an average of over 10 year of expertise in the distribution of electronic components. Based in Hongkong, we have already established firm and mutual-benefit business relationships with customers from,Europe,America and south Asia,supplying obsolete and hard-to-find components to meet their specific needs.

With the principle of “Quality Parts,Customers Priority,Honest Operation,and Considerate Service”,our business mainly focus on the distribution of electronic components. Line cards we deal with include Microchip,ALPS,ROHM,Xilinx,Pulse,ON,Everlight and Freescale. Main products comprise IC,Modules,Potentiometer,IC Socket,Relay,Connector.Our parts cover such applications as commercial,industrial, and automotives areas.

We are looking forward to setting up business relationship with you and hope to provide you with the best service and solution. Let us make a better world for our industry!



## Contact us

Tel: +86-755-8981 8866 Fax: +86-755-8427 6832

Email & Skype: info@chipsmall.com Web: www.chipsmall.com

Address: A1208, Overseas Decoration Building, #122 Zhenhua RD., Futian, Shenzhen, China



EconoPACK™2 Modul mit Trench/Feldstopp IGBT4 und Emitter Controlled 4 Diode und PressFIT / NTC / TIM

EconoPACK™2 module with Trench/Fieldstop IGBT4 and Emitter Controlled 4 diode and PressFIT / NTC / TIM

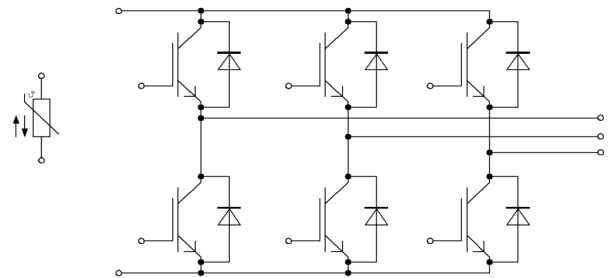
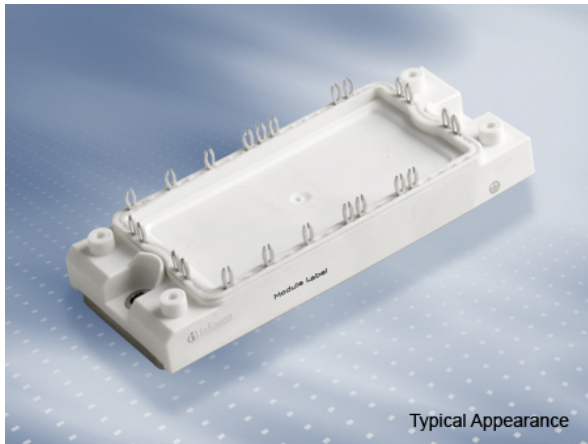

$V_{CES} = 1200V$

$I_{C\ nom} = 50A / I_{CRM} = 100A$

### Typische Anwendungen

- Hilfsumrichter
- Motorantriebe
- Servoumrichter

### Elektrische Eigenschaften

- Niedriges  $V_{CEsat}$
- $T_{vj\ op} = 150^{\circ}C$
- Trench IGBT 4
- $V_{CEsat}$  mit positivem Temperaturkoeffizienten

### Mechanische Eigenschaften

- $Al_2O_3$  Substrat mit kleinem thermischen Widerstand
- Hohe Last- und thermische Wechselfestigkeit
- Integrierter NTC Temperatur Sensor
- Kupferbodenplatte
- PressFIT Verbindungstechnik
- Standardgehäuse
- Thermisches Interface Material bereits aufgetragen

### Typical Applications

- Auxiliary inverters
- Motor drives
- Servo drives

### Electrical Features

- Low  $V_{CEsat}$
- $T_{vj\ op} = 150^{\circ}C$
- Trench IGBT 4
- $V_{CEsat}$  with positive temperature coefficient

### Mechanical Features

- $Al_2O_3$  substrate with low thermal resistance
- High power and thermal cycling capability
- Integrated NTC temperature sensor
- Copper base plate
- PressFIT contact technology
- Standard housing
- Pre-applied Thermal Interface Material

## Module Label Code

Barcode Code 128



DMX - Code



Content of the Code

| Content of the Code        | Digit   |
|----------------------------|---------|
| Module Serial Number       | 1 - 5   |
| Module Material Number     | 6 - 11  |
| Production Order Number    | 12 - 19 |
| Datecode (Production Year) | 20 - 21 |
| Datecode (Production Week) | 22 - 23 |

## IGBT, Wechselrichter / IGBT, Inverter Höchstzulässige Werte / Maximum Rated Values

|  |  |                   |       |   |
|--|--|-------------------|-------|---|
| Kollektor-Emitter-Sperrspannung<br>Collector-emitter voltage             | $T_{vj} = 25^{\circ}\text{C}$                                      | $V_{CES}$         | 1200  | V |
| Kollektor-Dauergleichstrom<br>Continuous DC collector current            | $T_H = 85^{\circ}\text{C}, T_{vj\text{max}} = 175^{\circ}\text{C}$ | $I_{C\text{nom}}$ | 50    | A |
| Periodischer Kollektor-Spitzenstrom<br>Repetitive peak collector current | $t_P = 1\text{ ms}$  | $I_{CRM}$         | 100   | A |
| Gate-Emitter-Spitzenspannung<br>Gate-emitter peak voltage                |  | $V_{GES}$         | +/-20 | V |

## Charakteristische Werte / Characteristic Values

|  |   |   | min.               | typ.                  | max. |             |   |
|--|---|---|--------------------|-----------------------|------|-------------|---|
| Kollektor-Emitter-Sättigungsspannung<br>Collector-emitter saturation voltage     | $I_C = 50\text{ A}, V_{GE} = 15\text{ V}$<br>$I_C = 50\text{ A}, V_{GE} = 15\text{ V}$<br>$I_C = 50\text{ A}, V_{GE} = 15\text{ V}$   | $T_{vj} = 25^{\circ}\text{C}$<br>$T_{vj} = 125^{\circ}\text{C}$<br>$T_{vj} = 150^{\circ}\text{C}$ | $V_{CE\text{sat}}$ | 1,85<br>2,15<br>2,25  | 2,15 | V<br>V<br>V |   |
| Gate-Schwellenspannung<br>Gate threshold voltage                                 | $I_C = 1,60\text{ mA}, V_{CE} = V_{GE}, T_{vj} = 25^{\circ}\text{C}$  |   | $V_{GEth}$         | 5,20                  | 5,80 | 6,40        | V   |
| Gateladung<br>Gate charge  | $V_{GE} = -15\text{ V} \dots +15\text{ V}$  |   | $Q_G$              | 0,38                  |      |             | $\mu\text{C}$                                   |
| Interner Gatewiderstand<br>Internal gate resistor                                | $T_{vj} = 25^{\circ}\text{C}$   |   | $R_{Gint}$         | 4,0                   |      |             | $\Omega$  |
| Eingangskapazität<br>Input capacitance   | $f = 1\text{ MHz}, T_{vj} = 25^{\circ}\text{C}, V_{CE} = 25\text{ V}, V_{GE} = 0\text{ V}$  |   | $C_{ies}$          | 2,80                  |      |             | nF  |
| Rückwirkungskapazität<br>Reverse transfer capacitance                            | $f = 1\text{ MHz}, T_{vj} = 25^{\circ}\text{C}, V_{CE} = 25\text{ V}, V_{GE} = 0\text{ V}$  |   | $C_{res}$          | 0,10                  |      |             | nF  |
| Kollektor-Emitter-Reststrom<br>Collector-emitter cut-off current                 | $V_{CE} = 1200\text{ V}, V_{GE} = 0\text{ V}, T_{vj} = 25^{\circ}\text{C}$  |   | $I_{CES}$          |                       |      | 1,0         | mA  |
| Gate-Emitter-Reststrom<br>Gate-emitter leakage current                           | $V_{CE} = 0\text{ V}, V_{GE} = 20\text{ V}, T_{vj} = 25^{\circ}\text{C}$  |   | $I_{GES}$          |                       |      | 100         | nA  |
| Einschaltverzögerungszeit, induktive Last<br>Turn-on delay time, inductive load  | $I_C = 50\text{ A}, V_{CE} = 600\text{ V}$<br>$V_{GE} = \pm 15\text{ V}$<br>$R_{Gon} = 15\ \Omega$  | $T_{vj} = 25^{\circ}\text{C}$<br>$T_{vj} = 125^{\circ}\text{C}$<br>$T_{vj} = 150^{\circ}\text{C}$ | $t_{don}$          | 0,13<br>0,15<br>0,15  |      |             | $\mu\text{s}$<br>$\mu\text{s}$<br>$\mu\text{s}$ |
| Anstiegszeit, induktive Last<br>Rise time, inductive load                        | $I_C = 50\text{ A}, V_{CE} = 600\text{ V}$<br>$V_{GE} = \pm 15\text{ V}$<br>$R_{Gon} = 15\ \Omega$  | $T_{vj} = 25^{\circ}\text{C}$<br>$T_{vj} = 125^{\circ}\text{C}$<br>$T_{vj} = 150^{\circ}\text{C}$ | $t_r$              | 0,02<br>0,03<br>0,035 |      |             | $\mu\text{s}$<br>$\mu\text{s}$<br>$\mu\text{s}$ |
| Abschaltverzögerungszeit, induktive Last<br>Turn-off delay time, inductive load  | $I_C = 50\text{ A}, V_{CE} = 600\text{ V}$<br>$V_{GE} = \pm 15\text{ V}$<br>$R_{Goff} = 15\ \Omega$   | $T_{vj} = 25^{\circ}\text{C}$<br>$T_{vj} = 125^{\circ}\text{C}$<br>$T_{vj} = 150^{\circ}\text{C}$ | $t_{doff}$         | 0,30<br>0,38<br>0,40  |      |             | $\mu\text{s}$<br>$\mu\text{s}$<br>$\mu\text{s}$ |
| Fallzeit, induktive Last<br>Fall time, inductive load                            | $I_C = 50\text{ A}, V_{CE} = 600\text{ V}$<br>$V_{GE} = \pm 15\text{ V}$<br>$R_{Goff} = 15\ \Omega$   | $T_{vj} = 25^{\circ}\text{C}$<br>$T_{vj} = 125^{\circ}\text{C}$<br>$T_{vj} = 150^{\circ}\text{C}$ | $t_f$              | 0,045<br>0,08<br>0,09 |      |             | $\mu\text{s}$<br>$\mu\text{s}$<br>$\mu\text{s}$ |
| Einschaltverlustenergie pro Puls<br>Turn-on energy loss per pulse                | $I_C = 50\text{ A}, V_{CE} = 600\text{ V}, L_S = 25\text{ nH}$<br>$V_{GE} = \pm 15\text{ V}, di/dt = 1300\text{ A}/\mu\text{s} (T_{vj} = 150^{\circ}\text{C})$<br>$R_{Gon} = 15\ \Omega$  | $T_{vj} = 25^{\circ}\text{C}$<br>$T_{vj} = 125^{\circ}\text{C}$<br>$T_{vj} = 150^{\circ}\text{C}$ | $E_{on}$           | 4,50<br>6,40<br>7,40  |      |             | mJ<br>mJ<br>mJ                                  |
| Abschaltverlustenergie pro Puls<br>Turn-off energy loss per pulse                | $I_C = 50\text{ A}, V_{CE} = 600\text{ V}, L_S = 25\text{ nH}$<br>$V_{GE} = \pm 15\text{ V}, du/dt = 3800\text{ V}/\mu\text{s} (T_{vj} = 150^{\circ}\text{C})$<br>$R_{Goff} = 15\ \Omega$ | $T_{vj} = 25^{\circ}\text{C}$<br>$T_{vj} = 125^{\circ}\text{C}$<br>$T_{vj} = 150^{\circ}\text{C}$ | $E_{off}$          | 2,50<br>4,10<br>4,50  |      |             | mJ<br>mJ<br>mJ                                  |
| Kurzschlußverhalten<br>SC data   | $V_{GE} \leq 15\text{ V}, V_{CC} = 800\text{ V}$<br>$V_{CEmax} = V_{CES} - L_{SCE} \cdot di/dt$ $t_P \leq 10\ \mu\text{s}, T_{vj} = 150^{\circ}\text{C}$                                  |   | $I_{SC}$           | 180                   |      |             | A   |
| Wärmewiderstand, Chip bis Kühlkörper<br>Thermal resistance, junction to heatsink | pro IGBT / per IGBT<br>valid with IFX pre-applied thermal interface material  |   | $R_{thJH}$         |                       |      | 0,671       | K/W   |
| Temperatur im Schaltbetrieb<br>Temperature under switching conditions            |   |   | $T_{vj\text{op}}$  | -40                   |      | 150         | $^{\circ}\text{C}$                              |

## Diode, Wechselrichter / Diode, Inverter

### Höchstzulässige Werte / Maximum Rated Values

|   |  |           |      |                      |
|---|--|-----------|------|----------------------|
| Periodische Spitzensperrspannung<br>Repetitive peak reverse voltage | $T_{vj} = 25^{\circ}\text{C}$  | $V_{RRM}$ | 1200 | V                    |
| Dauergleichstrom<br>Continuous DC forward current                   |  | $I_F$     | 50   | A                    |
| Periodischer Spitzenstrom<br>Repetitive peak forward current        | $t_P = 1\text{ ms}$  | $I_{FRM}$ | 100  | A                    |
| Grenzlastintegral<br>$I^2t$ - value                                 | $V_R = 0\text{ V}, t_P = 10\text{ ms}, T_{vj} = 125^{\circ}\text{C}$ | $I^2t$    | 560  | $\text{A}^2\text{s}$ |

### Charakteristische Werte / Characteristic Values

|  |   |   | min.               | typ.                 | max.  |   |
|--|---|---|--------------------|----------------------|-------|---|
| Durchlassspannung<br>Forward voltage   | $I_F = 50\text{ A}, V_{GE} = 0\text{ V}$<br>$I_F = 50\text{ A}, V_{GE} = 0\text{ V}$<br>$I_F = 50\text{ A}, V_{GE} = 0\text{ V}$          | $T_{vj} = 25^{\circ}\text{C}$<br>$T_{vj} = 125^{\circ}\text{C}$<br>$T_{vj} = 150^{\circ}\text{C}$ | $V_F$              | 1,70<br>1,65<br>1,65 | 2,15  | V<br>V<br>V                                     |
| Rückstromspitze<br>Peak reverse recovery current                                 | $I_F = 50\text{ A}, -di_F/dt = 1300\text{ A}/\mu\text{s} (T_{vj}=150^{\circ}\text{C})$<br>$V_R = 600\text{ V}$<br>$V_{GE} = -15\text{ V}$ | $T_{vj} = 25^{\circ}\text{C}$<br>$T_{vj} = 125^{\circ}\text{C}$<br>$T_{vj} = 150^{\circ}\text{C}$ | $I_{RM}$           | 70,0<br>75,0<br>77,0 |       | A<br>A<br>A                                     |
| Sperrverzögerungsladung<br>Recovered charge                                      | $I_F = 50\text{ A}, -di_F/dt = 1300\text{ A}/\mu\text{s} (T_{vj}=150^{\circ}\text{C})$<br>$V_R = 600\text{ V}$<br>$V_{GE} = -15\text{ V}$ | $T_{vj} = 25^{\circ}\text{C}$<br>$T_{vj} = 125^{\circ}\text{C}$<br>$T_{vj} = 150^{\circ}\text{C}$ | $Q_r$              | 5,10<br>9,30<br>10,0 |       | $\mu\text{C}$<br>$\mu\text{C}$<br>$\mu\text{C}$ |
| Abschaltenergie pro Puls<br>Reverse recovery energy                              | $I_F = 50\text{ A}, -di_F/dt = 1300\text{ A}/\mu\text{s} (T_{vj}=150^{\circ}\text{C})$<br>$V_R = 600\text{ V}$<br>$V_{GE} = -15\text{ V}$ | $T_{vj} = 25^{\circ}\text{C}$<br>$T_{vj} = 125^{\circ}\text{C}$<br>$T_{vj} = 150^{\circ}\text{C}$ | $E_{rec}$          | 1,70<br>3,20<br>3,60 |       | mJ<br>mJ<br>mJ                                  |
| Wärmewiderstand, Chip bis Kühlkörper<br>Thermal resistance, junction to heatsink | pro Diode / per diode<br>valid with IFX pre-applied thermal interface material  |   | $R_{thJH}$         |                      | 0,887 | K/W   |
| Temperatur im Schaltbetrieb<br>Temperature under switching conditions            |   |   | $T_{vj\text{ op}}$ | -40                  | 150   | $^{\circ}\text{C}$                              |

## NTC-Widerstand / NTC-Thermistor

### Charakteristische Werte / Characteristic Values

|  |   |  | min.         | typ. | max. |                  |
|--|---|--|--------------|------|------|------------------|
| Nennwiderstand<br>Rated resistance       | $T_{NTC} = 25^{\circ}\text{C}$                                |  | $R_{25}$     | 5,00 |      | $\text{k}\Omega$ |
| Abweichung von R100<br>Deviation of R100 | $T_{NTC} = 100^{\circ}\text{C}, R_{100} = 493\ \Omega$        |  | $\Delta R/R$ | -5   | 5    | %                |
| Verlustleistung<br>Power dissipation     | $T_{NTC} = 25^{\circ}\text{C}$                                |  | $P_{25}$     |      | 20,0 | mW               |
| B-Wert<br>B-value                        | $R_2 = R_{25} \exp [B_{25/50}(1/T_2 - 1/(298,15\text{ K}))]$  |  | $B_{25/50}$  | 3375 |      | K                |
| B-Wert<br>B-value                        | $R_2 = R_{25} \exp [B_{25/80}(1/T_2 - 1/(298,15\text{ K}))]$  |  | $B_{25/80}$  | 3411 |      | K                |
| B-Wert<br>B-value                        | $R_2 = R_{25} \exp [B_{25/100}(1/T_2 - 1/(298,15\text{ K}))]$ |  | $B_{25/100}$ | 3433 |      | K                |

Angaben gemäß gültiger Application Note.

Specification according to the valid application note.

## Modul / Module

|  |  |                     |                                |      |     |
|--|--|---------------------|--------------------------------|------|-----|
| Isolations-Prüfspannung<br>Isolation test voltage  | RMS, f = 50 Hz, t = 1 min.   | V <sub>ISOL</sub>   | 2,5                            |      | kV  |
| Material Modulgrundplatte<br>Material of module baseplate                                    |  |                     | Cu                             |      |     |
| Innere Isolation<br>Internal isolation   | Basisisolierung (Schutzklasse 1, EN61140)<br>basic insulation (class 1, IEC 61140)   |                     | Al <sub>2</sub> O <sub>3</sub> |      |     |
| Kriechstrecke<br>Creepage distance   | Kontakt - Kühlkörper / terminal to heatsink<br>Kontakt - Kontakt / terminal to terminal  |                     | 10,0                           |      | mm  |
| Luftstrecke<br>Clearance   | Kontakt - Kühlkörper / terminal to heatsink<br>Kontakt - Kontakt / terminal to terminal  |                     | 7,5                            |      | mm  |
| Vergleichszahl der Kriechwegbildung<br>Comperative tracking index                            |  | CTI                 | > 200                          |      |     |
|  |  |                     | min.    typ.    max.           |      |     |
| Wärmewiderstand, Gehäuse bis Kühlkörper<br>Thermal resistance, case to heatsink              | pro Modul / per module<br>$\lambda_{\text{Paste}} = 1 \text{ W/(m}\cdot\text{K)} / \lambda_{\text{grease}} = 1 \text{ W/(m}\cdot\text{K)}$ | R <sub>thCH</sub>   | 0,02                           |      | K/W |
| Modulstreuinduktivität<br>Stray inductance module  |  | L <sub>sCE</sub>    | 19                             |      | nH  |
| Modulleitungswiderstand, Anschlüsse - Chip<br>Module lead resistance, terminals - chip       | T <sub>H</sub> = 25°C, pro Schalter / per switch   | R <sub>CC+EE'</sub> | 1,80                           |      | mΩ  |
| Lagertemperatur<br>Storage temperature   |  | T <sub>stg</sub>    | -40                            | 125  | °C  |
| Höchstzulässige<br>Bodenplattenbetriebstemperatur<br>Maximum baseplate operation temperature |  | T <sub>BPmax</sub>  |                                | 125  | °C  |
| Anzugsdrehmoment f. Modulmontage<br>Mounting torque for modul mounting                       | Schraube M5 - Montage gem. gültiger Applikationsschrift<br>Screw M5 - Mounting according to valid application note                         | M                   | 3,00                           | 6,00 | Nm  |
| Gewicht<br>Weight  |  | G                   | 180                            |      | g   |

Lagerung und Transport von Modulen mit TIM => siehe AN2012-07  
Storage and shipment of modules with TIM => see AN2012-07

**Ausgangskennlinie IGBT, Wechselrichter (typisch)**  
**output characteristic IGBT, Inverter (typical)**

$I_C = f(V_{CE})$   
 $V_{GE} = 15\text{ V}$

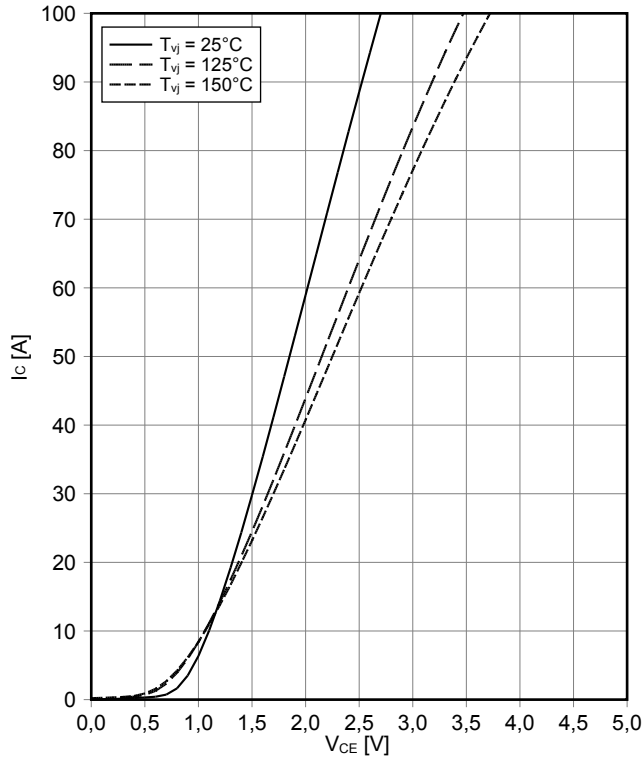

**Ausgangskennlinienfeld IGBT, Wechselrichter (typisch)**  
**output characteristic IGBT, Inverter (typical)**

$I_C = f(V_{CE})$   
 $T_{vj} = 150^\circ\text{C}$

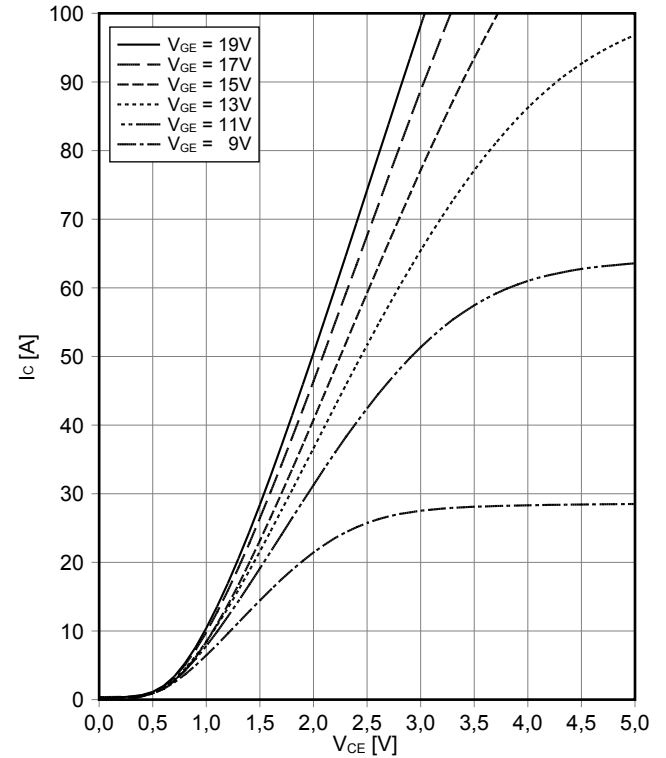

**Übertragungscharakteristik IGBT, Wechselrichter (typisch)**  
**transfer characteristic IGBT, Inverter (typical)**

$I_C = f(V_{GE})$   
 $V_{CE} = 20\text{ V}$

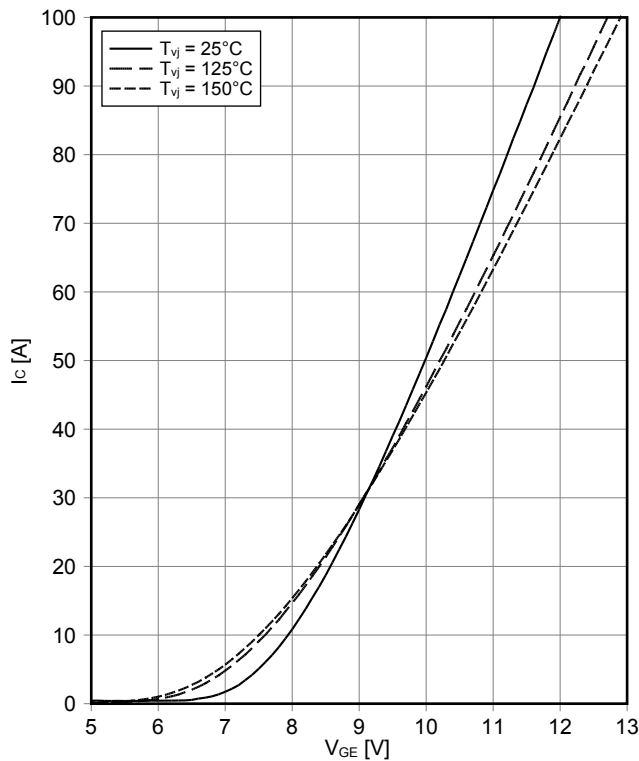

**Schaltverluste IGBT, Wechselrichter (typisch)**  
**switching losses IGBT, Inverter (typical)**

$E_{on} = f(I_C)$ ,  $E_{off} = f(I_C)$   
 $V_{GE} = \pm 15\text{ V}$ ,  $R_{Gon} = 15\ \Omega$ ,  $R_{Goff} = 15\ \Omega$ ,  $V_{CE} = 600\text{ V}$

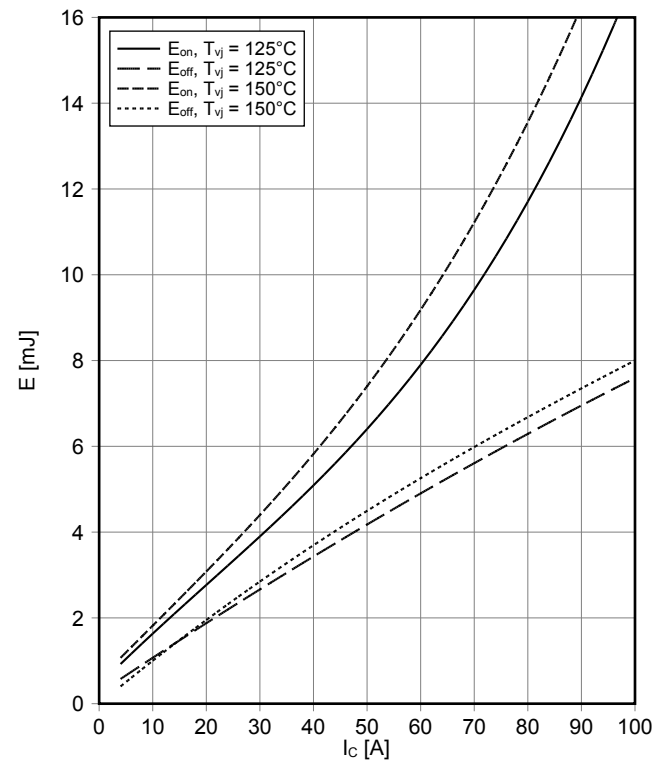

### Schaltverluste IGBT, Wechselrichter (typisch) switching losses IGBT, Inverter (typical)

$E_{on} = f(R_G), E_{off} = f(R_G)$   
 $V_{GE} = \pm 15\text{ V}, I_C = 50\text{ A}, V_{CE} = 600\text{ V}$

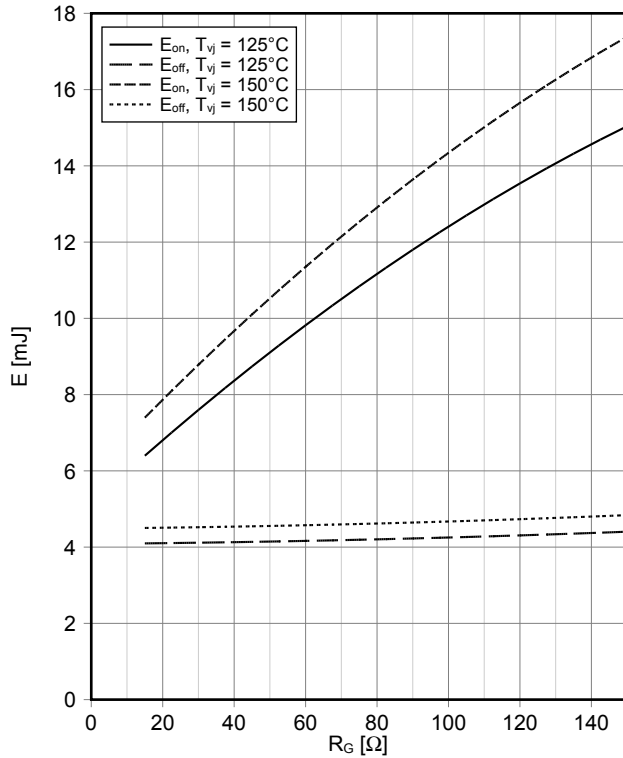

### Transienter Wärmewiderstand IGBT, Wechselrichter transient thermal impedance IGBT, Inverter

$Z_{thJH} = f(t)$

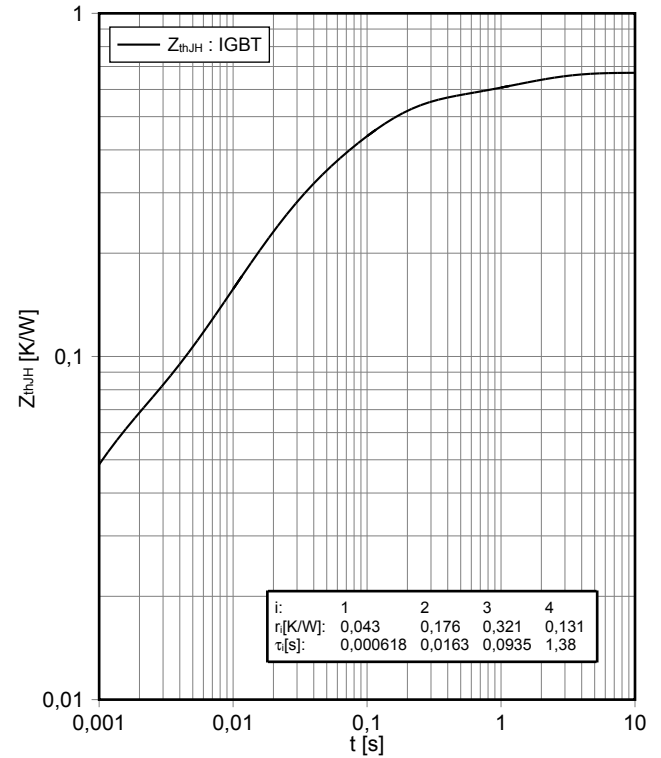

### Sicherer Rückwärts-Arbeitsbereich IGBT, Wechselrichter (RBSOA) reverse bias safe operating area IGBT, Inverter (RBSOA)

$I_C = f(V_{CE})$   
 $V_{GE} = \pm 15\text{ V}, R_{Goff} = 15\ \Omega, T_{vj} = 150^\circ\text{C}$

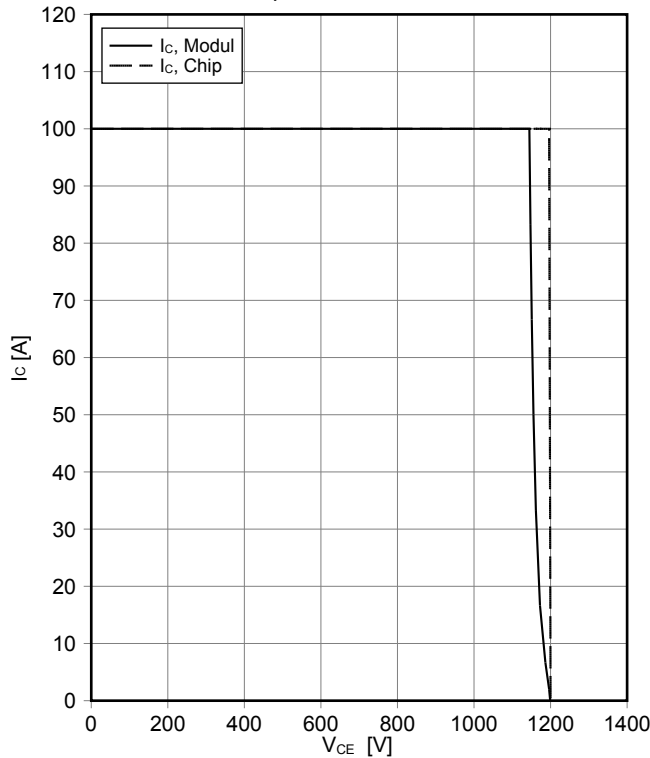

### Durchlasskennlinie der Diode, Wechselrichter (typisch) forward characteristic of Diode, Inverter (typical)

$I_F = f(V_F)$

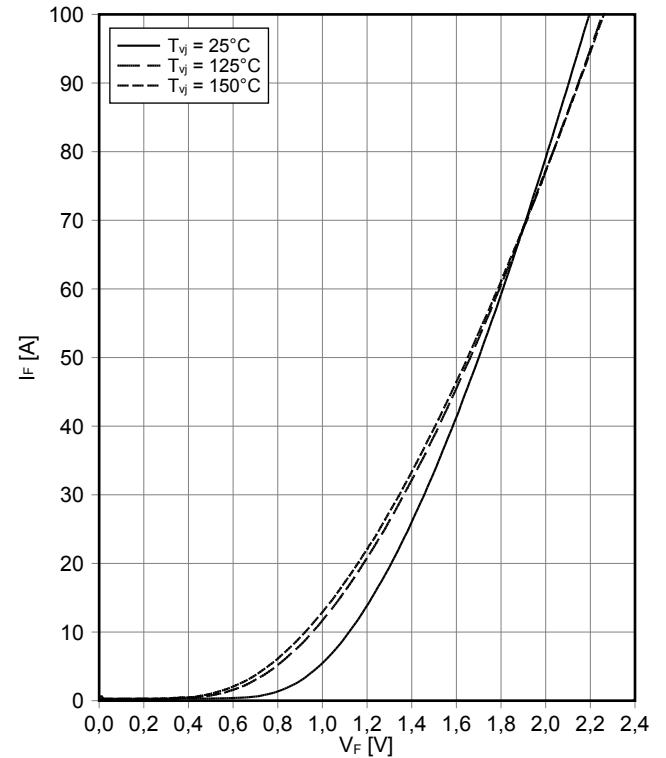

**Schaltverluste Diode, Wechselrichter (typisch)**  
**switching losses Diode, Inverter (typical)**

$E_{rec} = f(I_F)$   
 $R_{Gon} = 15 \Omega, V_{CE} = 600 V$

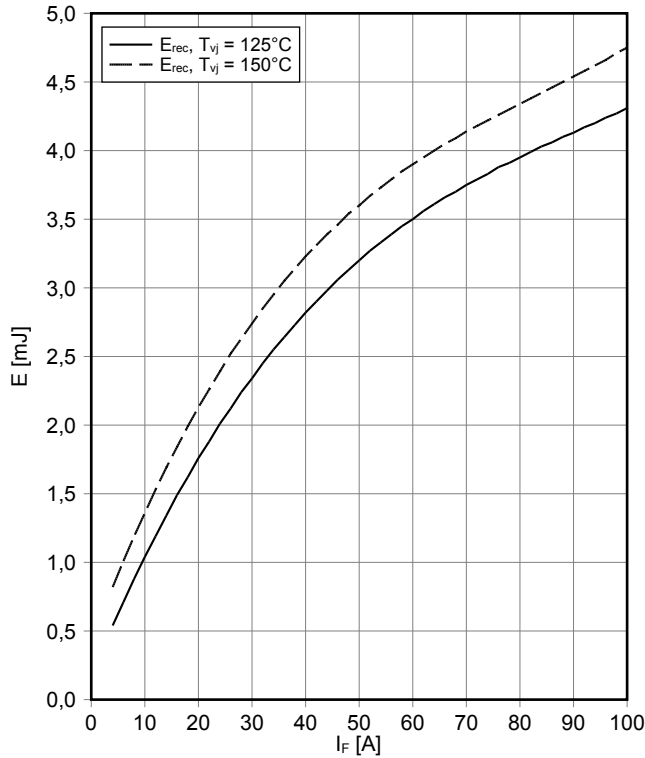

**Schaltverluste Diode, Wechselrichter (typisch)**  
**switching losses Diode, Inverter (typical)**

$E_{rec} = f(R_G)$   
 $I_F = 50 A, V_{CE} = 600 V$

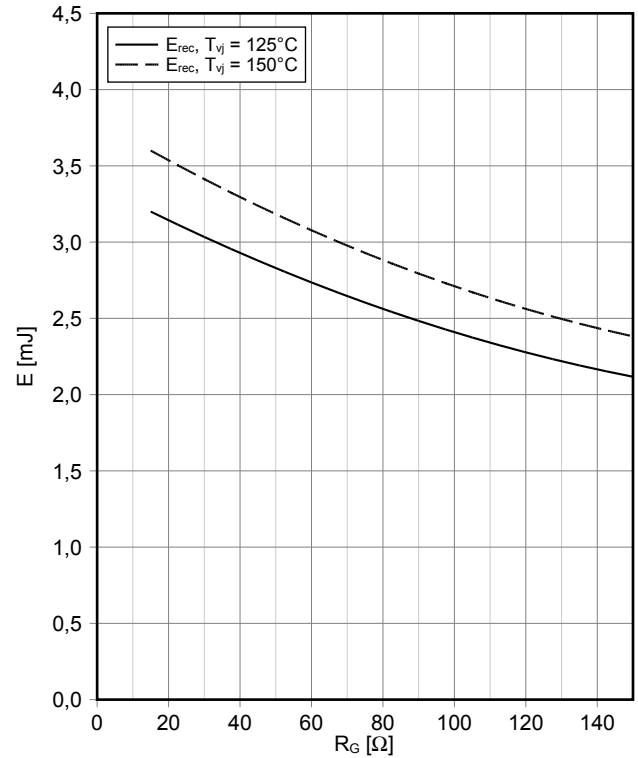

**Transienter Wärmewiderstand Diode, Wechselrichter**  
**transient thermal impedance Diode, Inverter**

$Z_{thJH} = f(t)$

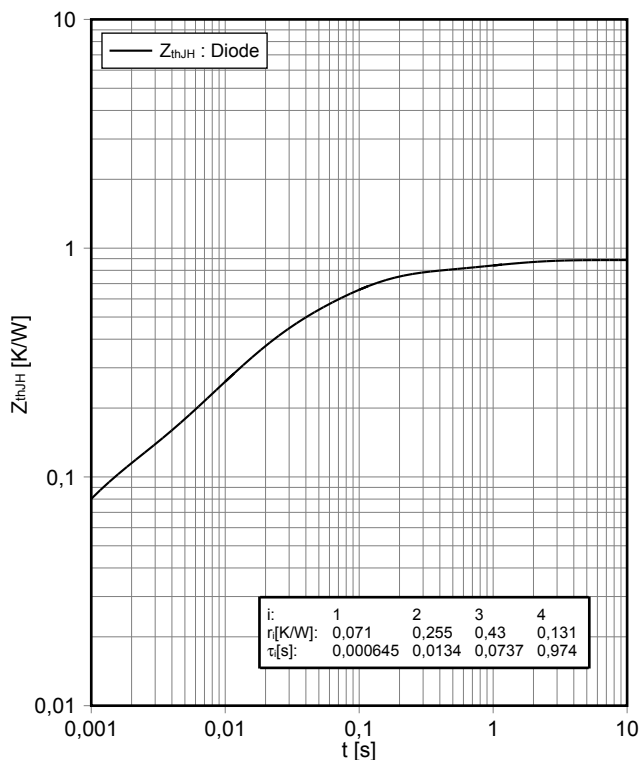

**NTC-Widerstand-Temperaturkennlinie (typisch)**  
**NTC-Thermistor-temperature characteristic (typical)**

$R = f(T)$

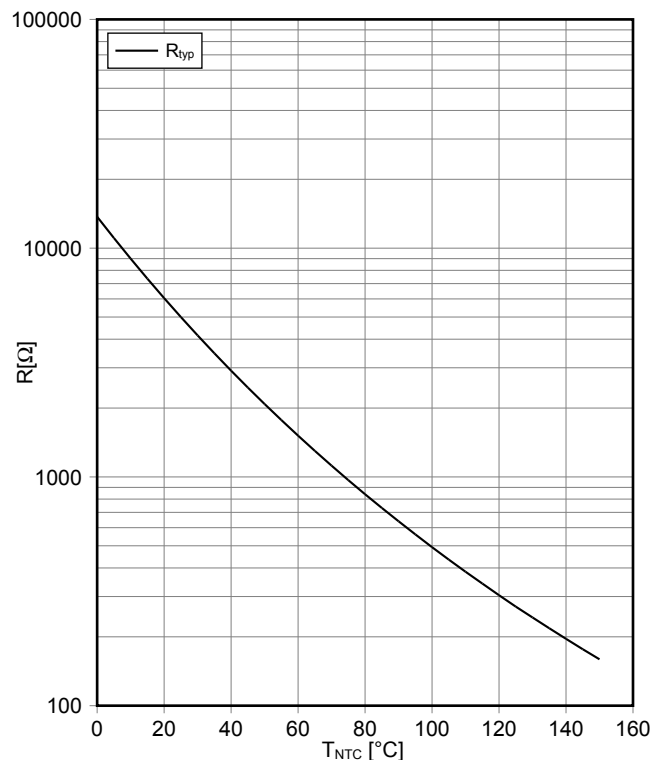



## Schaltplan / Circuit diagram

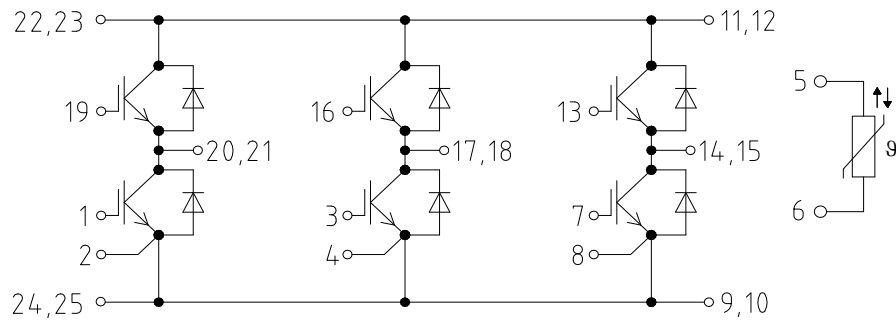

## Gehäuseabmessungen / Package outlines

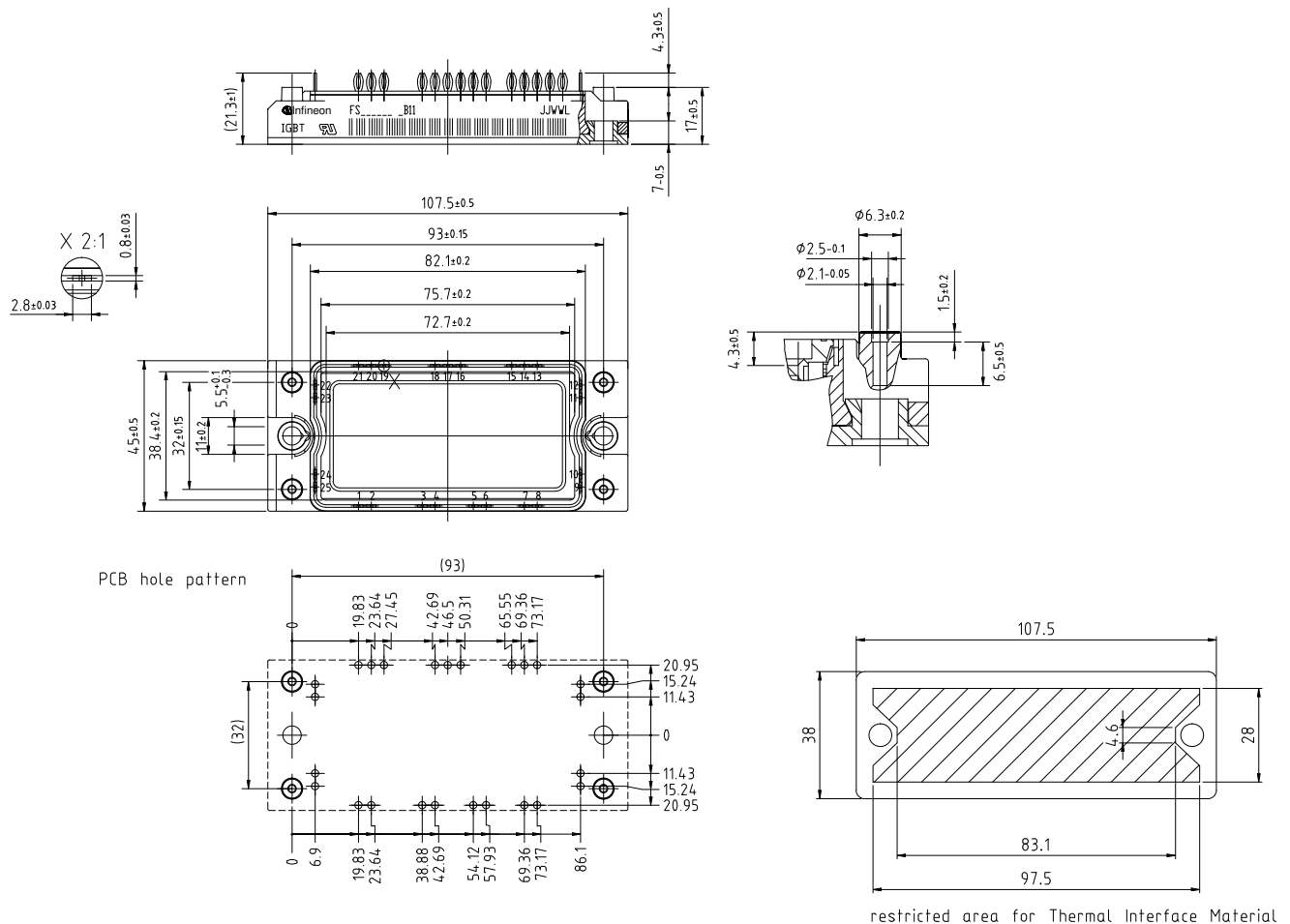

- Tolerance of PCB hole pattern  $\pm 0.1$
- hole specifications see AN 2007-09
- Diameters of plated holes  $\phi$  2.14mm - 2.29mm
- Diameter of drill  $\phi$  2.35mm

**Trademarks**

All referenced product or service names and trademarks are the property of their respective owners.

**Edition 2017-08-08**

**Published by  
Infineon Technologies AG  
81726 München, Germany**

**© 2017 Infineon Technologies AG.  
All Rights Reserved.**

**Do you have a question about this document?  
Email: [erratum@infineon.com](mailto:erratum@infineon.com)**

**WICHTIGER HINWEIS**

Die in diesem Dokument enthaltenen Angaben stellen keinesfalls Garantien für die Beschaffenheit oder Eigenschaften des Produktes ("Beschaffenhheitsgarantie") dar. Für Beispiele, Hinweise oder typische Werte, die in diesem Dokument enthalten sind, und/oder Angaben, die sich auf die Anwendung des Produktes beziehen, ist jegliche Gewährleistung und Haftung von Infineon Technologies ausgeschlossen, einschließlich, ohne hierauf beschränkt zu sein, die Gewähr dafür, dass kein geistiges Eigentum Dritter verletzt ist.

Des Weiteren stehen sämtliche, in diesem Dokument enthaltenen Informationen, unter dem Vorbehalt der Einhaltung der in diesem Dokument festgelegten Verpflichtungen des Kunden sowie aller im Hinblick auf das Produkt des Kunden sowie die Nutzung des Infineon Produktes in den Anwendungen des Kunden anwendbaren gesetzlichen Anforderungen, Normen und Standards durch den Kunden.

Die in diesem Dokument enthaltenen Daten sind ausschließlich für technisch geschultes Fachpersonal bestimmt. Die Beurteilung der Eignung dieses Produktes für die beabsichtigte Anwendung sowie die Beurteilung der Vollständigkeit der in diesem Dokument enthaltenen Produktdaten für diese Anwendung obliegt den technischen Fachabteilungen des Kunden.

Sollten Sie von uns weitere Informationen im Zusammenhang mit dem Produkt, der Technologie, Lieferbedingungen bzw. Preisen benötigen, wenden Sie sich bitte an das nächste Vertriebsbüro von Infineon Technologies ([www.infineon.com](http://www.infineon.com)).

**WARNHINWEIS**

Aufgrund der technischen Anforderungen können Produkte gesundheitsgefährdende Substanzen enthalten. Bei Fragen zu den in diesem Produkt enthaltenen Substanzen, setzen Sie sich bitte mit dem nächsten Vertriebsbüro von Infineon Technologies in Verbindung.

Sofern Infineon Technologies nicht ausdrücklich in einem schriftlichen, von vertretungsberechtigten Infineon Mitarbeitern unterzeichneten Dokument zugestimmt hat, dürfen Produkte von Infineon Technologies nicht in Anwendungen eingesetzt werden, in welchen vernünftigerweise erwartet werden kann, dass ein Fehler des Produktes oder die Folgen der Nutzung des Produktes zu Personenverletzungen führen.

**IMPORTANT NOTICE**

The information given in this document shall in no event be regarded as a guarantee of conditions or characteristics ("Beschaffenhheitsgarantie"). With respect to any examples, hints or any typical values stated herein and/or any information regarding the application of the product, Infineon Technologies hereby disclaims any and all warranties and liabilities of any kind, including without limitation warranties of non-infringement of intellectual property rights of any third party.

In addition, any information given in this document is subject to customer's compliance with its obligations stated in this document and any applicable legal requirements, norms and standards concerning customer's products and any use of the product of Infineon Technologies in customer's applications.

The data contained in this document is exclusively intended for technically trained staff. It is the responsibility of customer's technical departments to evaluate the suitability of the product for the intended application and the completeness of the product information given in this document with respect to such application.

For further information on the product, technology, delivery terms and conditions and prices please contact your nearest Infineon Technologies office ([www.infineon.com](http://www.infineon.com)).

**WARNINGS**

Due to technical requirements products may contain dangerous substances. For information on the types in question please contact your nearest Infineon Technologies office.

Except as otherwise explicitly approved by Infineon Technologies in a written document signed by authorized representatives of Infineon Technologies, Infineon Technologies' products may not be used in any applications where a failure of the product or any consequences of the use thereof can reasonably be expected to result in personal injury.