



Chipsmall Limited consists of a professional team with an average of over 10 year of expertise in the distribution of electronic components. Based in Hongkong, we have already established firm and mutual-benefit business relationships with customers from,Europe,America and south Asia,supplying obsolete and hard-to-find components to meet their specific needs.

With the principle of “Quality Parts,Customers Priority,Honest Operation,and Considerate Service”,our business mainly focus on the distribution of electronic components. Line cards we deal with include Microchip,ALPS,ROHM,Xilinx,Pulse,ON,Everlight and Freescale. Main products comprise IC,Modules,Potentiometer,IC Socket,Relay,Connector.Our parts cover such applications as commercial,industrial, and automotives areas.

We are looking forward to setting up business relationship with you and hope to provide you with the best service and solution. Let us make a better world for our industry!



## Contact us

Tel: +86-755-8981 8866 Fax: +86-755-8427 6832

Email & Skype: info@chipsmall.com Web: www.chipsmall.com

Address: A1208, Overseas Decoration Building, #122 Zhenhua RD., Futian, Shenzhen, China





Is Now Part of



**ON Semiconductor®**

To learn more about ON Semiconductor, please visit our website at  
[www.onsemi.com](http://www.onsemi.com)

Please note: As part of the Fairchild Semiconductor integration, some of the Fairchild orderable part numbers will need to change in order to meet ON Semiconductor's system requirements. Since the ON Semiconductor product management systems do not have the ability to manage part nomenclature that utilizes an underscore (\_), the underscore (\_) in the Fairchild part numbers will be changed to a dash (-). This document may contain device numbers with an underscore (\_). Please check the ON Semiconductor website to verify the updated device numbers. The most current and up-to-date ordering information can be found at [www.onsemi.com](http://www.onsemi.com). Please email any questions regarding the system integration to [Fairchild\\_questions@onsemi.com](mailto:Fairchild_questions@onsemi.com).

ON Semiconductor and the ON Semiconductor logo are trademarks of Semiconductor Components Industries, LLC dba ON Semiconductor or its subsidiaries in the United States and/or other countries. ON Semiconductor owns the rights to a number of patents, trademarks, copyrights, trade secrets, and other intellectual property. A listing of ON Semiconductor's product/patent coverage may be accessed at [www.onsemi.com/site/pdf/Patent-Marking.pdf](http://www.onsemi.com/site/pdf/Patent-Marking.pdf). ON Semiconductor reserves the right to make changes without further notice to any products herein. ON Semiconductor makes no warranty, representation or guarantee regarding the suitability of its products for any particular purpose, nor does ON Semiconductor assume any liability arising out of the application or use of any product or circuit, and specifically disclaims any and all liability, including without limitation special, consequential or incidental damages. Buyer is responsible for its products and applications using ON Semiconductor products, including compliance with all laws, regulations and safety requirements or standards, regardless of any support or applications information provided by ON Semiconductor. "Typical" parameters which may be provided in ON Semiconductor data sheets and/or specifications can and do vary in different applications and actual performance may vary over time. All operating parameters, including "Typicals" must be validated for each customer application by customer's technical experts. ON Semiconductor does not convey any license under its patent rights nor the rights of others. ON Semiconductor products are not designed, intended, or authorized for use as a critical component in life support systems or any FDA Class 3 medical devices or medical devices with a same or similar classification in a foreign jurisdiction or any devices intended for implantation in the human body. Should Buyer purchase or use ON Semiconductor products for any such unintended or unauthorized application, Buyer shall indemnify and hold ON Semiconductor and its officers, employees, subsidiaries, affiliates, and distributors harmless against all claims, costs, damages, and expenses, and reasonable attorney fees arising out of, directly or indirectly, any claim of personal injury or death associated with such unintended or unauthorized use, even if such claim alleges that ON Semiconductor was negligent regarding the design or manufacture of the part. ON Semiconductor is an Equal Opportunity/Affirmative Action Employer. This literature is subject to all applicable copyright laws and is not for resale in any manner.



ON Semiconductor®

February 2017

# FSL306LR Green Mode Buck Switch

## Features

- Built-in Avalanche Rugged SenseFET: 650 V
- Fixed Operating Frequency: 50 kHz
- No-Load Power Consumption: < 25 mW at 230 V<sub>AC</sub> with External Bias; <120 mW at 230 V<sub>AC</sub> without External Bias
- No Need for Auxiliary Bias Winding
- Frequency Modulation for Attenuating EMI
- Pulse-by-Pulse Current Limiting
- Ultra-Low Operating Current: 250 μA
- Built-in Soft-Start and Startup Circuit
- Adjustable Peak Current Limit
- Built-in Transconductance (Error) Amplifier
- Various Protections: Overload Protection (OLP), Over-Voltage Protection (OVP), Feedback Open Loop Protection (FB\_OLP), AOC (Abnormal Over-Current Protection), Thermal Shutdown (TSD)
- Fixed 650 ms Restart Time for Safe Auto-Restart Mode of All Protections

## Applications

- SMPS for Home Appliances and Industrial Applications
- SMPS for Auxiliary Power

## Description

The FSL306LR integrate Pulse Width Modulator (PWM) and SenseFET is specifically designed for high-performance offline buck, buck-boost, and non-isolation flyback Switched Mode Power Supplies (SMPS) with minimal external components. This device integrates a high-voltage power regulator that enables operation without auxiliary bias winding. An internal transconductance amplifier reduces external components for the feedback compensation circuit.

The integrated PWM controller includes: 10 V regulator for no external bias circuit, Under-Voltage Lockout (UVLO), Leading-Edge Blanking (LEB), an optimized gate turn-on / turn-off driver, EMI attenuator, Thermal Shutdown (TSD), temperature-compensated precision current sources for loop compensation, and fault-protection circuitry. Protections include: Overload Protection (OLP), Over-Voltage Protection (OVP), Feedback Open Loop Protection (FB\_OLP), and Abnormal Over-Current Protection (AOC). FSL306LR offers good soft-start performance during startup.

The internal high-voltage startup switch and the Burst-Mode operation with very low operating current reduce the power loss in Standby Mode. As the result, it is possible to reach power loss of 120 mW without external bias and 25 mW with external bias when input voltage is 230 V<sub>AC</sub>.

## Ordering Information

Part Number	Operating Junction Temperature	PKG	Packing Method	Typical Output Power <sup>(1)</sup>			
				Current Limit	R <sub>DS(ON),MAX</sub>	85 V <sub>AC</sub> ~ 265 V <sub>AC</sub> & Open Frame <sup>(2)</sup>	
						Buck Application <sup>(3)</sup>	Flyback Application
FSL306LRN	-40°C ~125°C	7-DIP	Rail	0.45 A	18 Ω	3 W	7 W
FSL306LRLX		7-LSOP	Tape & Reel				

### Notes:

1. The junction temperature can limit the maximum output power.
2. Maximum practical continuous power in an open-frame design at 50°C ambient.
3. Based on 15 V output voltage condition. Output voltage can limit the maximum output power.



## Pin Configuration

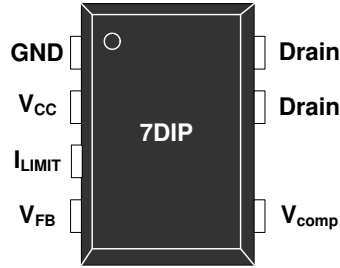

Figure 4. Pin Configuration

## Pin Definitions

Pin #	Name	Description
1	GND	<b>Ground.</b> SenseFET source terminal on the primary side and internal control ground.
2	V <sub>CC</sub>	<b>Positive Supply Voltage Input.</b> This pin is the positive supply input, which provides the internal operating current for startup and steady-state operation. This pin voltage is regulated to 10 V, without the external bias circuit, via internal switch (see Figure 3). When the external bias voltage is higher than 10 V, it disables the internal high-voltage regulator and reduces power consumption.
3	I <sub>LIMIT</sub>	<b>Peak Current Limit.</b> Adjusts the peak current limit of the SenseFET. The internal 50 μA current source is diverted to the parallel combination of an internal 46 kΩ (3R + R) resistors and any external resistor to GND on this pin to determine the peak current limit.
4	V <sub>FB</sub>	<b>Feedback Voltage.</b> Inverting input of the transconductance amplifier. This pin controls converter output voltage by outputting a current proportional to the difference between the reference voltage and the output voltage divided by external resistors.
5	V <sub>COMP</sub>	<b>Comp Voltage.</b> Output of the transconductance amplifier. The compensation networks are placed between the V <sub>COMP</sub> and GND pins to achieve stability and good dynamic performance.
6,7	Drain	<b>Drain.</b> High-voltage power SenseFET drain connection. In addition, during startup and steady-state operation; the internal high-voltage current source supplies internal bias and charges the external capacitor connected to the V <sub>CC</sub> pin. Once V <sub>CC</sub> reaches 8 V, all internal blocks are activated. The internal high-voltage current source is enabled until V <sub>CC</sub> reaches 10 V. After that, the internal high-voltage regulator turns on and off regularly to maintain V <sub>CC</sub> at 10 V.

## Absolute Maximum Ratings

Stresses exceeding the absolute maximum ratings may damage the device. The device may not function or be operable above the recommended operating conditions and stressing the parts to these levels is not recommended. In addition, extended exposure to stresses above the recommended operating conditions may affect device reliability. The absolute maximum ratings are stress ratings only.  $T_A = 25\text{ }^\circ\text{C}$ , unless otherwise specified.

Symbol	Parameter	Min.	Max.	Unit
$V_{DS}$	Drain Pin Voltage	-0.3	650.0	V
$V_{CC}$	Supply Voltage	-0.3	26.0	V
$V_{COMP}$	$V_{COMP}$ Pin Voltage	-0.3	Internally Clamped Voltage <sup>(4)</sup>	V
$V_{FB}$	Feedback Voltage	-0.3	12.0	V
$I_{LIMIT}$	Current Limit Pin Voltage	-0.3	12.0	V
$I_{DM}$	Drain Current Pulsed <sup>(5)</sup>		2.8	A
$E_{AS}$	Single Pulsed Avalanche Energy <sup>(6)</sup>		10.5	mJ
$P_D$	Total Power Dissipation		1.25	W
$T_J$	Operating Junction Temperature <sup>(7)</sup>	-40	125	$^\circ\text{C}$
	Maximum Junction Temperature		150	$^\circ\text{C}$
$T_{STG}$	Storage Temperature	-55	150	$^\circ\text{C}$

### Notes:

- $V_{COMP}$  is clamped by internal clamping diode (11 V,  $I_{CLAMP\_MAX} < 100\text{ }\mu\text{A}$ )
- Repetitive rating: pulse width is limited by maximum junction temperature.
- $L=10\text{ mH}$ , starting  $T_J=25\text{ }^\circ\text{C}$ .
- Although this parameter guarantees IC operation, it does not guarantee all electrical characteristics.

## Thermal Impedance

$T_A=25\text{ }^\circ\text{C}$  unless otherwise specified.

Symbol	Parameter	Value	Unit
$\theta_{JA}$	Junction-to-Ambient Thermal Impedance <sup>(8)</sup>	100	$^\circ\text{C/W}$

### Note:

- JEDEC recommended environment, JESD51-2, and test board, JESD51-3, with minimum land pattern.

## ESD Capability

Symbol	Parameter	Value	Unit
ESD	Human Body Model, JESD22-A114 <sup>(9)</sup>	4	kV
	Charged Device Model, JESD22-C101 <sup>(9)</sup>	2	

### Note:

- Meets JEDEC standards JESD 22-A114 and JESD 22-C101.

## Electrical Characteristics

T<sub>A</sub> = 25°C unless otherwise specified.

Symbol	Parameter	Conditions	Min.	Typ.	Max.	Unit
<b>SenseFET Section</b>						
B <sub>V</sub> DSS	Drain Source Breakdown Voltage	V <sub>CC</sub> = 0 V, I <sub>D</sub> = 250 μA	650			V
I <sub>DSS</sub>	Zero Gate Voltage Drain Current	V <sub>DS</sub> = 520 V, T <sub>A</sub> = 125°C			250	μA
R <sub>DS(ON)</sub>	Drain-Source On-State Resistance	V <sub>GS</sub> = 10 V, I <sub>D</sub> = 0.3 A		12	18	Ω
C <sub>ISS</sub>	Input Capacitances	V <sub>GS</sub> = 0 V, V <sub>DS</sub> = 25 V, f = 1 MHz		97		pF
C <sub>OSS</sub>	Output Capacitance	V <sub>GS</sub> = 0 V, V <sub>DS</sub> = 25 V, f = 1 MHz		13.6		pF
C <sub>RSS</sub>	Reverse Transfer Capacitance	V <sub>GS</sub> = 0 V, V <sub>DS</sub> = 25 V, f = 1 MHz		2.4		pF
t <sub>r</sub>	Rise Time	V <sub>DD</sub> = 325 V, I <sub>D</sub> = 0.7 A		7.6		ns
t <sub>f</sub>	Fall Time	V <sub>DD</sub> = 325 V, I <sub>D</sub> = 0.7 A		26.1		ns
<b>Control Section</b>						
f <sub>OSC</sub>	Switching Frequency	V <sub>COMP</sub> = 2.5 V	45	50	55	kHz
f <sub>M</sub>	Frequency Modulation <sup>(10)</sup>	V <sub>COMP</sub> = 2.5 V, Randomly		±3		kHz
t <sub>on,max</sub>	Maximum Turn-On Time	V <sub>COMP</sub> = 2.5 V	11.2	13.3	15.4	μs
V <sub>START</sub>	UVLO Threshold Voltage	V <sub>COMP</sub> = 0 V, V <sub>CC</sub> Sweep	7.2	8.0	8.8	V
V <sub>STOP</sub>		After Turn On	6.3	7.0	7.7	V
I <sub>PK</sub>	Current Limit Source Current	V <sub>COMP</sub> = 2.5 V	35	50	65	μA
t <sub>SS</sub>	Soft-Start Time	V <sub>COMP</sub> = 2.5 V	7	10	13	ms
<b>Burst Mode Section</b>						
V <sub>BURH</sub>	Burst-mode HIGH Threshold Voltage	V <sub>CC</sub> = 15 V, V <sub>COMP</sub> Increase	0.58	0.65	0.72	V
V <sub>BURL</sub>	Burst-mode LOW Threshold Voltage	V <sub>CC</sub> = 15 V, V <sub>COMP</sub> Decrease	0.52	0.59	0.66	V
HYS <sub>BUR</sub>	Burst-mode Hysteresis			60		mV
<b>Protection Section</b>						
I <sub>LIM</sub>	Peak Current Limit	V <sub>COMP</sub> = 2.5 V, di/dt = 300 mA/μs,	0.40	0.45	0.50	A
t <sub>CLD</sub>	Current Limit Delay <sup>(10)</sup>				200	ns
V <sub>OLP</sub>	Overload Protection	V <sub>COMP</sub> Increase	2.7	3.0	3.3	V
V <sub>AOCP</sub>	Abnormal Over-Current Protection <sup>(10)</sup>	V <sub>COMP</sub> = 2.5 V	0.8	1.0	1.2	V
t <sub>LEB</sub>	Leading-Edge Blanking Time <sup>(10)</sup>			200		ns
V <sub>FB_OLP</sub>	FB Open Loop Protection	V <sub>FB</sub> Decrease	0.4	0.5	0.6	V
V <sub>OVP</sub>	Over-Voltage Protection	V <sub>CC</sub> Increase	23.0	24.5	26.0	V
TSD	Thermal Shutdown Temperature <sup>(10)</sup>		125	135	150	°C
HYSTSD	TSD Hysteresis Temperature <sup>(10)</sup>			60		°C
t <sub>DELAY</sub>	Over Load Protection Delay <sup>(10)</sup>	V <sub>COMP</sub> > 3 V		40		ms
t <sub>RESTART</sub>	Restart Time After Protection <sup>(10)</sup>			650		ms
<b>Transconductance Amplifier Section</b>						
G <sub>m</sub>	Transconductance of Error Amplifier		190	240	290	μmho
V <sub>REF</sub>	Voltage Feedback Reference		2.45	2.50	2.55	V
I <sub>EA,SR</sub>	Output Sourcing Current	V <sub>FB</sub> = V <sub>REF</sub> - 0.05 V		-12		μA
I <sub>EA,SK</sub>	Output Sink Current	V <sub>FB</sub> = V <sub>REF</sub> + 0.05 V		12		μA

Continued on the following page...

## Electrical Characteristics

$T_A = 25^\circ\text{C}$  unless otherwise specified.

Symbol	Parameter	Conditions	Min.	Typ.	Max.	Unit
<b>High-Voltage Regulator Section</b>						
V <sub>HVREG</sub>	HV Regulator Voltage	$V_{\text{COMP}} = 0\text{ V}$ , $V_{\text{DRAIN}} = 40\text{ V}$	9	10	11	V
<b>Total Device Section</b>						
I <sub>OP1</sub>	Operating Supply Current (Control Part Only, without Switching)	$0\text{ V} < V_{\text{COMP}} < V_{\text{BURL}}$		0.25	0.35	mA
I <sub>OP2</sub>	Operating Supply Current (While Switching)	$V_{\text{BURL}} < V_{\text{COMP}} < V_{\text{OLP}}$		0.8	1.3	mA
I <sub>CH</sub>	Startup Charging Current	$V_{\text{CC}} = 0\text{ V}$ , $V_{\text{DRAIN}} > 40\text{ V}$		6		mA
I <sub>START</sub>	Startup Current	$V_{\text{CC}} = \text{Before } V_{\text{START}}$ , $V_{\text{COMP}} = 0\text{ V}$		120	155	$\mu\text{A}$
V <sub>DRAIN</sub>	Minimum Drain Supply Voltage	$V_{\text{CC}} = V_{\text{COMP}} = 0\text{ V}$ , $V_{\text{DRAIN}}$ Increase		35		V

### Notes:

10. Though guaranteed by design, they are not 100% tested in production.



## Typical Performance Characteristics

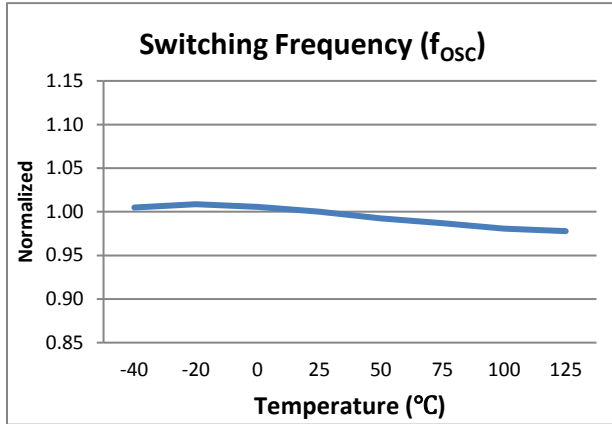

Figure 5. Operating Frequency vs. Temperature

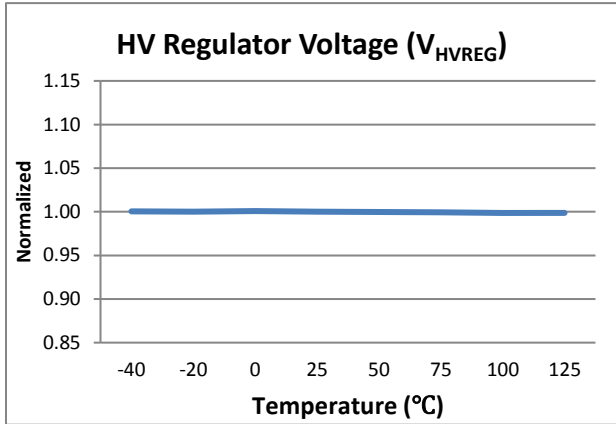

Figure 6. HV Regulator Voltage vs. Temperature

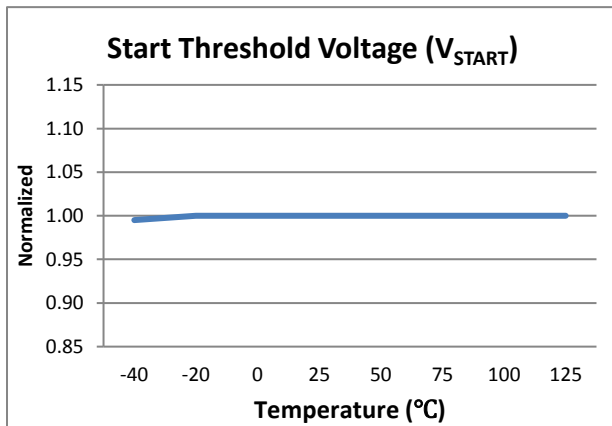

Figure 7. Start Threshold Voltage vs. Temperature

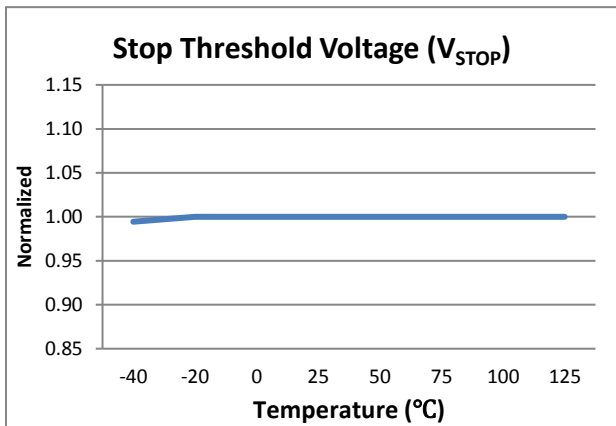

Figure 8. Stop Threshold Voltage vs. Temperature

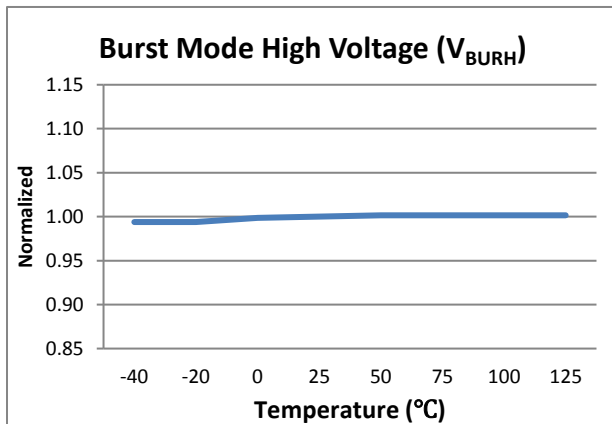

Figure 9. Burst Mode High Voltage vs. Temperature

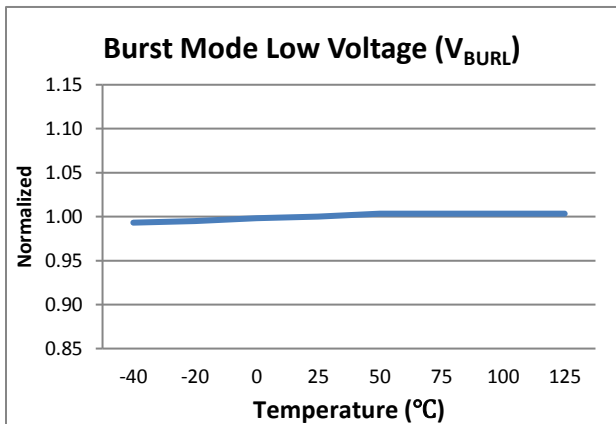
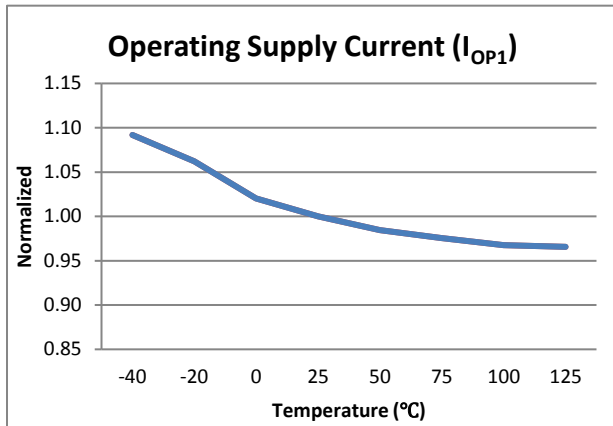
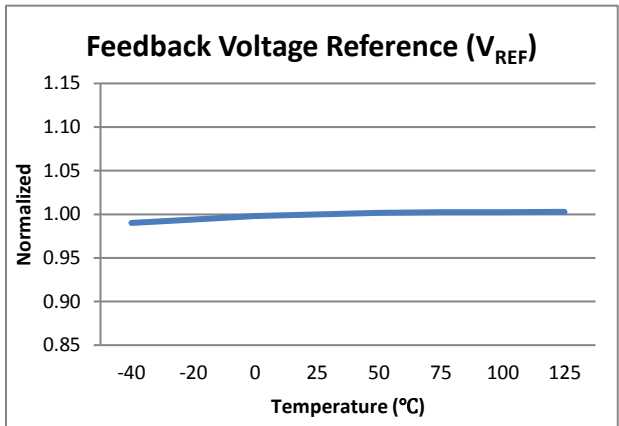

Figure 10. Burst Mode Low Voltage vs. Temperature

**Typical Performance Characteristics** (Continued)



**Figure 11. Operating Supply Current 1 vs. Temperature**



**Figure 12. Feedback Voltage Reference vs. Temperature**

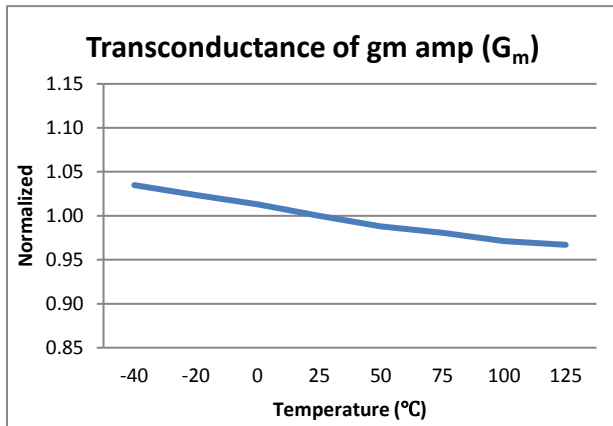

**Figure 13. Transconductance of gm Amplifier vs. Temperature**

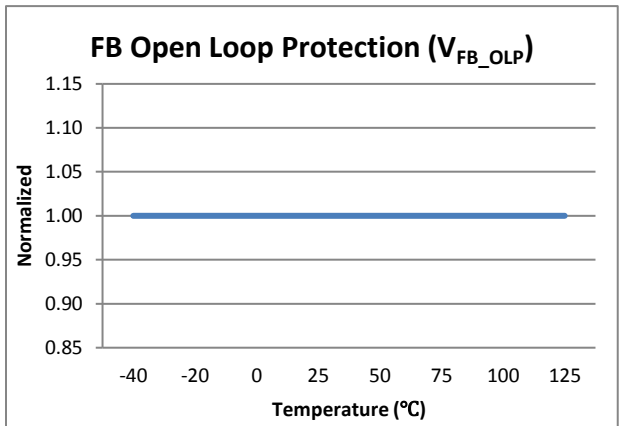

**Figure 14. FB Open Loop Protection Voltage vs. Temperature**

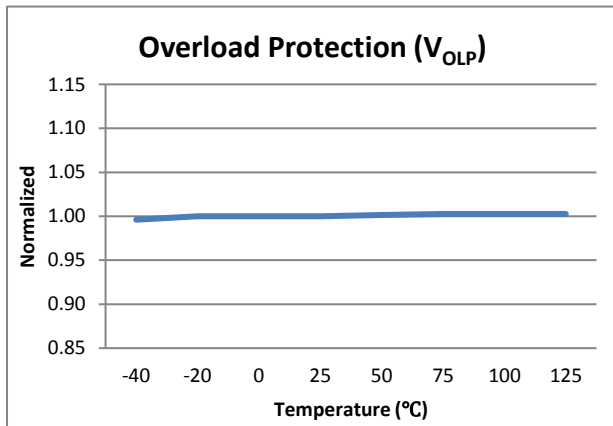

**Figure 15. Overload Protection vs. Temperature**

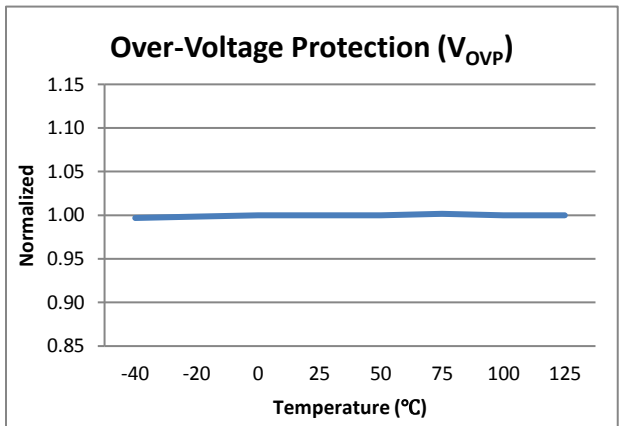

**Figure 16. Over-Voltage Protection vs. Temperature**

## Functional Description

### 1. Startup and High-Voltage Regulator

During startup, an internal high-voltage current source ( $I_{CH}$ ) of the high-voltage regulator supplies the internal bias current ( $I_{START}$ ) and charges the external capacitor ( $C_A$ ) connected to the  $V_{CC}$  pin, as illustrated in Figure 17. This internal high-voltage current source is enabled until  $V_{CC}$  reaches 10 V. During steady-state operation, this internal high-voltage regulator ( $HV_{REG}$ ) maintains the  $V_{CC}$  with 10 V and provides operating current ( $I_{OP}$ ) for all internal circuits. Therefore, FSL306LR needs no external bias circuit. The high-voltage regulator is disabled when the external bias is higher than 10 V.

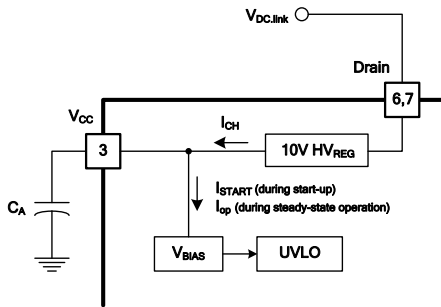

Figure 17. Startup and  $HV_{REG}$  Block

### 2. Oscillator Block

The oscillator frequency is set internally and the FSL306LR have random frequency fluctuation functions. Fluctuation of the switching frequency can reduce EMI by spreading the energy over a wider frequency range than the bandwidth measured by the EMI test equipment. The amount of EMI reduction is directly related to the range of the frequency variation. The range of frequency variation is fixed internally; however, its selection is randomly chosen by the combination of an external feedback voltage and an internal free-running oscillator. This randomly chosen switching frequency effectively spreads the EMI noise near switching frequency and allows the use of a cost-effective inductor instead of an AC input line filter to satisfy world-wide EMI requirements.

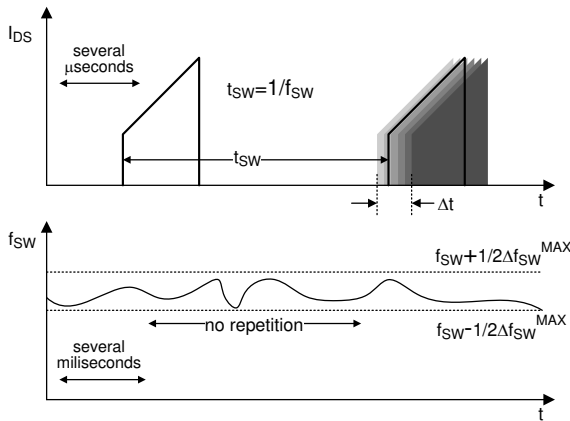

Figure 18. Frequency Fluctuation Waveform

### 3. Feedback Control

employs current-mode control with a transconductance amplifier for feedback control, as shown in Figure 19. Two resistors are typically used on the  $V_{FB}$  pin to sense output voltage. An external compensation circuit is recommended on the  $V_{COMP}$  pin to control output voltage. A built-in transconductance amplifier accurately controls output voltage without external components, such as Zener diode and transistor.

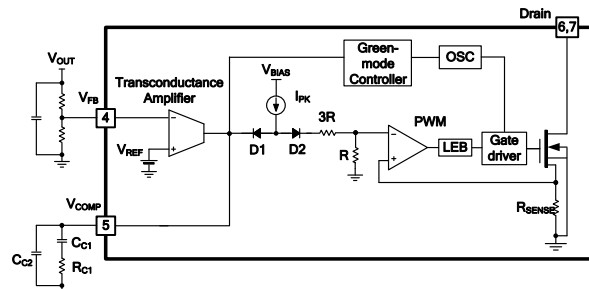

Figure 19. Pulse Width Modulation (PWM) Circuit

#### 3.1 Transconductance Amplifier ( $g_m$ Amplifier)

The output of the transconductance amplifier sources and sinks the current, respectively, to and from the compensation circuit connected on the  $V_{COMP}$  pin (see Figure 20). This compensated  $V_{COMP}$  pin voltage controls the switching duty cycle by comparing with the voltage across the  $R_{SENSE}$ . When the feedback pin voltage exceeds the internal reference voltage ( $V_{REF}$ ) of 2.5 V; the transconductance amplifier sinks the current from the compensation circuit,  $V_{COMP}$  is pulled down, and the duty cycle is reduced. This typically occurs when input voltage is increased or output load is decreased. A two-pole and one-zero compensation network is recommended for optimal output voltage control and AC dynamics. Typically 220 nF, 220 k $\Omega$ , and 330 pF are used for  $C_{C1}$ ,  $R_{C1}$ , and  $C_{C2}$ , respectively.

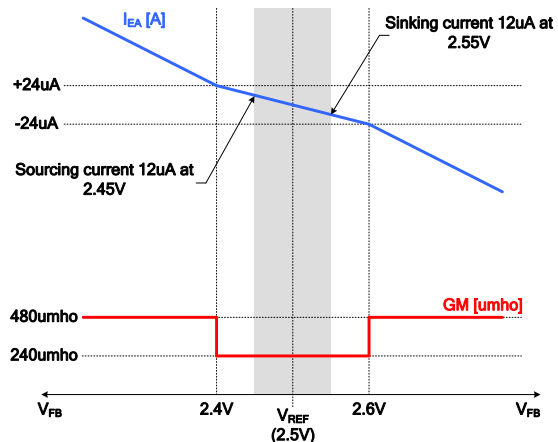

Figure 20. Characteristics of  $g_m$  Amplifier

#### 3.2 Pulse-by-pulse Current Limit

Because current-mode control is employed, the peak current flowing through the SenseFET is limited by the inverting input of PWM comparator, as shown in Figure 19. Assuming that 50  $\mu$ A current source flows only through the internal resistors ( $3R + R = 46$  k $\Omega$ ),

the cathode voltage of diode D2 is about 2.4 V. Since D1 is blocked when  $V_{COMP}$  exceeds 2.4 V, the maximum voltage of the cathode of D2 is clamped at this voltage. Therefore, the peak value of the current of the SenseFET is limited.

### 3.3 Leading Edge Blanking (LEB)

At the instant the internal SenseFET is turned on; primary-side capacitance and secondary-side rectifier diode reverse recovery of flyback application, the freewheeling diode reverse recovery, and other parasitic capacitance of buck application typically cause a high-current spike through the SenseFET. Excessive voltage across the sensing resistor ( $R_{SENSE}$ ) leads to incorrect feedback operation in the current-mode control. To counter this effect, the FSL306LR have Leading-Edge Blanking (LEB) circuits (see Figure 19). This circuit inhibits the PWM comparator for a short time ( $t_{LEB}$ ) after the SenseFET is turned on.

## 4. Protection Circuits

The protective functions include Overload Protection (OLP), Over-Voltage Protection (OVP), Under-Voltage Lockout (UVLO), Feedback Open Loop Protection (FB\_OLP), Abnormal Over-Current Protection (AOCP), and Thermal Shutdown (TSD). All of the protections operate in Auto-Restart Mode. Since these protection circuits are fully integrated inside the IC without external components, reliability is improved without increasing cost and PCB space. If a fault condition occurs, switching is terminated and the SenseFET remains off. At the same time, internal protection timing control is activated to decrease power consumption and stress on passive and active components during Auto-Restart. When internal protection timing control is activated,  $V_{CC}$  is regulated with 10 V through the internal high-voltage regulator until switching is terminated. This internal protection timing control continues until restart time (650 ms) is counted. After counting to 650 ms, the internal high-voltage regulator is disabled and  $V_{CC}$  is decreased. When  $V_{CC}$  reaches the UVLO stop voltage  $V_{STOP}$  (7 V), the protection is reset and the internal high-voltage voltage current source charges the  $V_{CC}$  capacitor via the drain pin again. When  $V_{CC}$  reaches the UVLO start voltage,  $V_{START}$  (8 V), the FSL306LR resumes normal operation. In this manner, Auto-Restart can alternately enable and disable the switching of the power SenseFET until the fault condition is eliminated.

### 4.1 Overload Protection (OLP)

Overload is defined as the load current exceeding a preset level due to an unexpected event. In this situation, the protection circuit should be activated to protect the SMPS. However, even when the SMPS operates normally, the OLP circuit can be enabled during the load transition or startup. To avoid this undesired operation, an internal fixed delay (40 ms) circuit determines whether it is a transient situation or a true overload situation (see Figure 21). The current-mode feedback path limits the maximum power current and, when the output consumes more than this maximum power, the output voltage ( $V_o$ ) decreases below its rated voltage. This reduces feedback pin voltage, which increases the output current of the internal transconductance amplifier. Eventually  $V_{COMP}$  is increased. When  $V_{COMP}$

reaches 3 V, the internal fixed OLP delay (40 ms) is activated. After this delay, the switching operation is terminated, as shown in Figure 22.

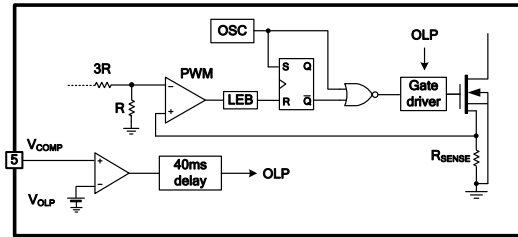

Figure 21. Overload Protection Internal Circuit

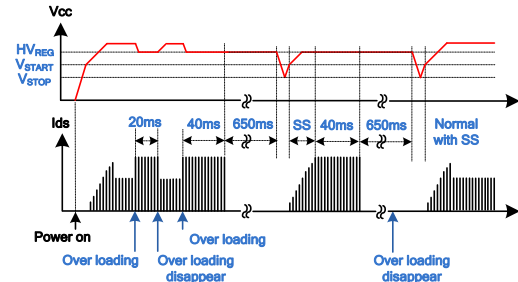

Figure 22. Overload Protection (OLP) Waveform

### 4.2 Abnormal Over-Current Protection (AOCP)

When output is shorted at high input voltage, much higher drain current peak than pulse-by-pulse current limit can flow through the SenseFET because turn on time is the same as the minimum turn-on time of FSL306LR. Even OLP is occasionally not enough to protect the FSL306LR in that abnormal case, since severe current stress is imposed on the SenseFET until OLP is triggered. FSL306LR includes the internal Abnormal Over-Current Protection (AOCP) circuit shown in Figure 23. The voltage across the  $R_{SENSE}$  is compared with a preset AOCP level ( $V_{AOCP}$ ) after  $t_{LEB}$  and, if the voltage across the  $R_{SENSE}$  is greater than the AOCP level, the set signal is triggered after four switching times by an internal 2-bit counter, shutting down the SMPS, as shown in Figure 24. This LEB time can inhibit mis-triggering due to the leading-edge spike.

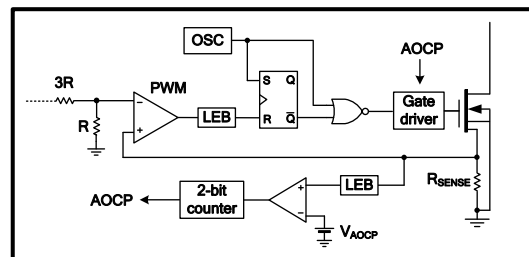

Figure 23. AOCP Circuit

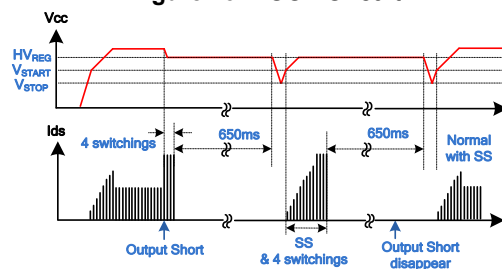

Figure 24. AOCP Waveform

### 4.3 Thermal Shutdown (TSD)

The SenseFET and control IC integrated on the same package makes it easier to detect the temperature of the SenseFET. When the junction temperature exceeds 135°C, thermal shutdown is activated. The FSL306LR are restarted after the temperature decreases to 60°C.

### 4.4 Over-Voltage Protection (OVP)

If any feedback loop components fail due to a soldering defect,  $V_{COMP}$  climbs up in manner similar to the overload situation, forcing the preset maximum current to be supplied to the SMPS until the OLP is triggered. In this case, excessive energy is provided to the output and the output voltage may exceed the rated voltage before the OLP is activated. To prevent this situation, an Over-Voltage Protection (OVP) circuit is employed. In general, output voltage can be monitored through  $V_{CC}$  and, when  $V_{CC}$  exceeds 24.5 V, OVP is triggered, resulting in termination of switching operation. To avoid undesired activation of OVP during normal operation,  $V_{CC}$  should be designed below 24.5 V (see Figure 25).

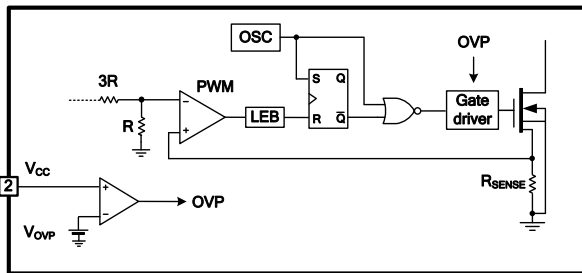

Figure 25. Over Voltage Protection Circuit

### 4.5 Feedback Open Loop Protection (FB\_OLP)

In the event of a feedback loop failure, especially a shorted lower-side resistor of the feedback pin; not only does  $V_{COMP}$  rise in a similar manner to the overload situation, but  $V_{FB}$  starts to drop to IC ground level. Although OLP and OVP also can protect the SMPS in this situation, FB\_OLP can reduce stress on SenseFET more. If there is no FB\_OLP, output voltage is much higher than rated voltage before OLP or OVP trigger. When  $V_{FB}$  drops below 0.5 V, FB\_OLP is activated, switching off. To avoid undesired activation during startup, this function is disabled during soft-start time.

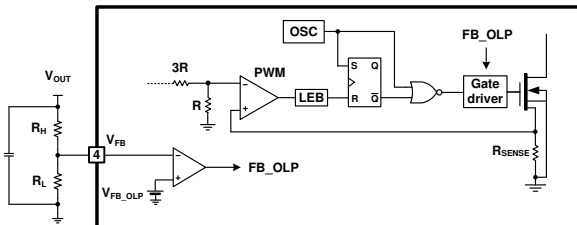

Figure 26. Feedback Open-loop Protection Circuit

## 5. Soft-Start

The internal soft-start circuit slowly increases the SenseFET current after it starts. The typical soft-start time is 10 ms, as shown in Figure 27, where progressive increments of the SenseFET current are allowed during startup. The pulse width to the power switching device is progressively increased to establish the correct working conditions for transformers, inductors, and capacitors. The voltage on the output capacitors is gradually increased to smoothly establish the required output voltage. Soft-start also helps to prevent transformer saturation and reduces stress on the secondary diode.

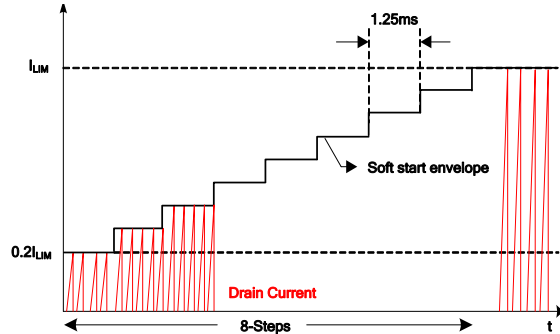

Figure 27. Internal Soft-Start

## 6. Burst Mode Operation

To minimize power dissipation in Standby Mode, the FSL306LR enters Burst Mode. As the load decreases, the comp voltage ( $V_{COMP}$ ) decreases. As shown in Figure 28, the device automatically enters Burst Mode when the feedback voltage drops below  $V_{BURL}$ . At this point, switching stops and the output voltages start to drop at a rate dependent on the standby current load. This causes  $V_{COMP}$  to rise. Once it passes  $V_{BURH}$ , switching resumes.  $V_{COMP}$  then falls and the process repeats. Burst Mode alternately enables and disables switching of the SenseFET and reduces switching loss in Standby Mode.

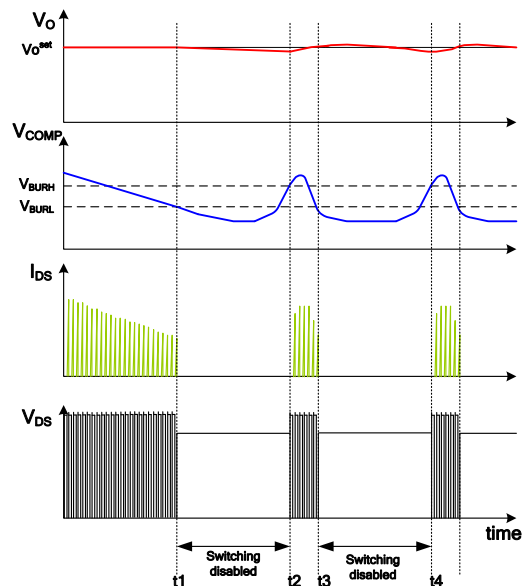

Figure 28. Burst Mode Operation

### 7. Green Mode Operation

As output load condition is reduced, the switching loss becomes the largest power loss factor. FSL306LR uses the V<sub>COMP</sub> pin voltage to monitor output load condition. As output load decreases, V<sub>COMP</sub> decreases and switching frequency declines, as shown in Figure 29. Once V<sub>COMP</sub> falls to 0.8 V, the switching frequency varies between 21 kHz and 23 kHz before Burst Mode operation. At Burst Mode operation, random frequency fluctuation still functions.

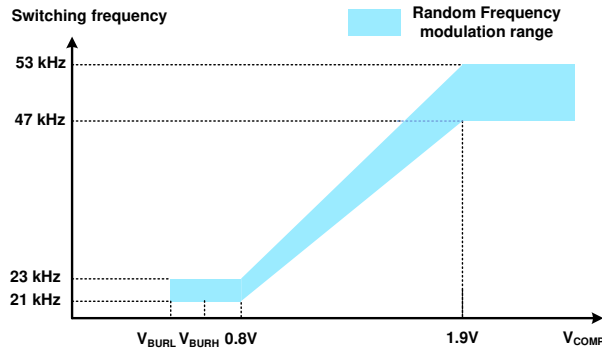

Figure 29. Green Mode Operation

### 8. Adjusting Current Limit

As shown in Figure 30, a combined 46 kΩ internal resistance (3R + R) is connected to the inverting lead on the PWM comparator. An external resistance of R<sub>x</sub> on the I<sub>LIMIT</sub> pin forms a parallel resistance with the 46 kΩ when the internal diodes are biased by the main current source of 50 μA. For example, FSL306LR have a typical SenseFET peak current limit of 0.45 A. Current limit can be adjusted to 0.3 A by inserting R<sub>x</sub> between the I<sub>LIMIT</sub> pin and the ground. The value of the R<sub>x</sub> can be estimated by the following equation:

$$0.45 \text{ A} : 0.3 \text{ A} = (46 \text{ k}\Omega + R_x) : R_x \tag{1}$$

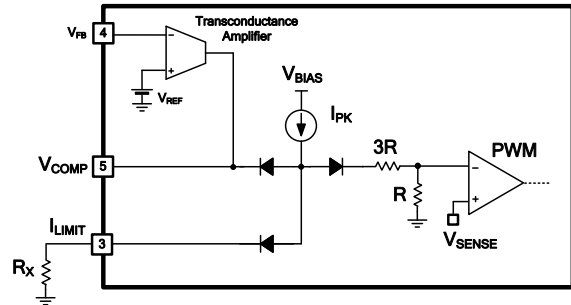

Figure 30. Current Limit Adjustment

### Typical Application Circuit

Application	Input Voltage	Rated Output	Rated Power
Auxiliary Power	85 ~ 300 V <sub>AC</sub>	12 V (150 mA)	2.05 W
Power Supply		5 V (50 mA)	

#### Key Design Notes:

- Small current rating inductors (L1 & L2), an SMD-type resistor (R1), and an additional AC rectifying diode (D2) are placed for good EMI performance.
- External bias circuitry, a SMD-type resistor (R2), and a small-signal diode (D5) reduce power loss of the internal high-voltage regulator.

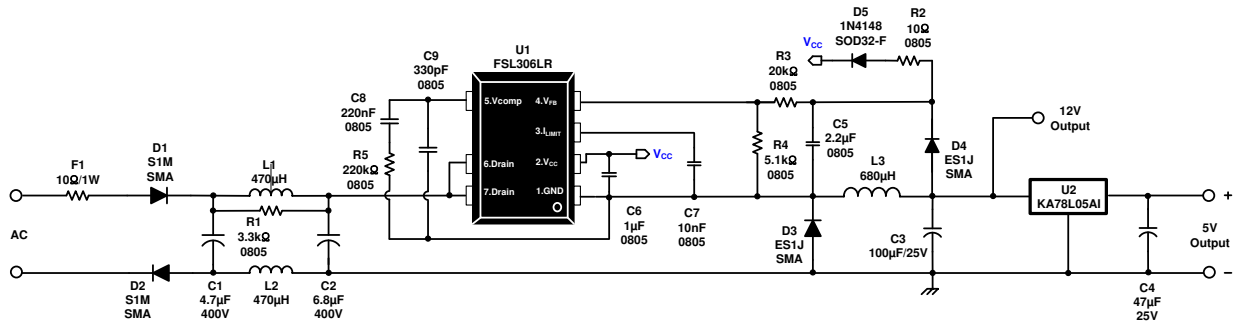
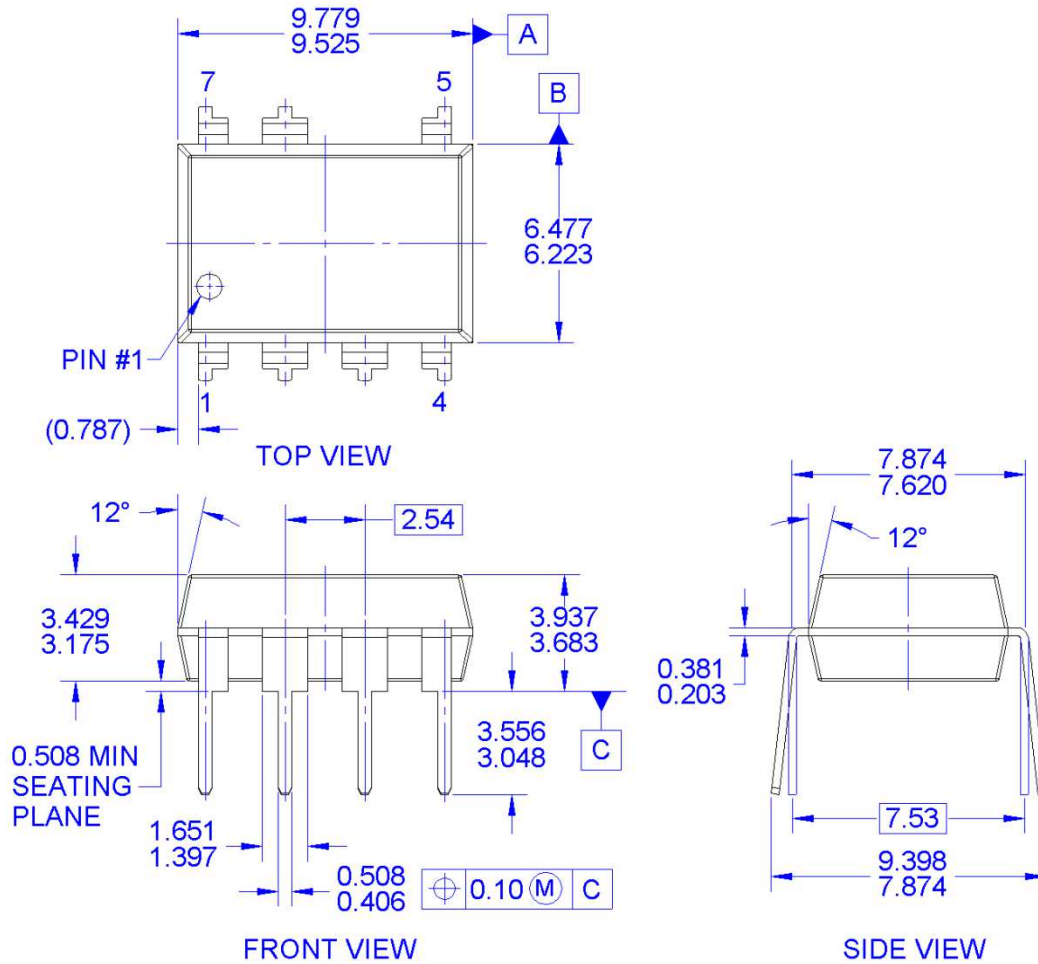

Figure 31. Schematic

Table 1. Bill of Materials

Part	Value	Note	Part	Value	Note
<b>Fuse</b>			<b>Diode</b>		
F1	10 W	1 W, Fusible Resistor	D1	S1M	1 A / 1000 V General-Purpose Rectifier ON Semiconductor
<b>Resistor</b>			D2	S1M	1 A / 1000 V General-Purpose Rectifier ON Semiconductor
R1	3.3 kΩ	SMD 0805, 5%	D3	ES1J	1 A / 600 V Ultra-Fast Recovery Rectifier ON Semiconductor
R2	10 Ω	SMD 0805, 5%	D4	ES1J	1 A / 600 V Ultra-Fast Recovery Rectifier ON Semiconductor
R3	20 kΩ	SMD 0805, 1%	D5	1N4148	High Conductance Fast Diode ON Semiconductor
R4	5.1 kΩ	SMD 0805, 1%	<b>Inductor</b>		
R5	220 kΩ	SMD 0805, 5%	L1	470 μH	SYNTON
<b>Capacitor</b>			L2	470 μH	SYNTON
C1	4.7 μF / 400 V	Electrolytic	L3	680 μH	PKS-0807-681K 3L Electronic
C2	6.8 μF / 400 V	Electrolytic	<b>IC</b>		
C3	100 μF / 25 V	Electrolytic	U1	FSL306LRN / FSL306LRL	ON Semiconductor
C4	47 μF / 25 V	Electrolytic	U2	KA78L05AIMTF	0.1 A / 5 V Positive Voltage Regulator ON Semiconductor
C5	2.2 μF	SMD 0805			
C6	1 μF	SMD 0805			
C7	10 nF	SMD 0805			
C8	220 nF	SMD 0805			
C9	330 pF	SMD 0805			

## Physical Dimensions



### NOTES:

- A. REFERENCE JEDEC MS-001, VARIATION BA EXCEPT FOR NUMBER OF LEADS.
- B. DIMENSIONS ARE IN MILLIMETERS
- C. DIMENSIONS AND TOLERANCES PER ASME Y14.5M, 2009
- D. DIMENSIONS ARE EXCLUSIVE OF BURRS, MOLD FLASH AND TIE BAR EXTRUSIONS.
- E. DRAWING FILENAME: MKT-NA07Drev2

**Figure 32. 7-Lead, Molded Dual Inline Package (MDIP), JEDEC MS-001, .300 inch Wide**

*Package drawings are provided as a service to customers considering ON Semiconductor components. Drawings may change in any manner without notice. Please note the revision and/or date on the drawing and contact an ON Semiconductor representative to verify or obtain the most recent revision. Package specifications do not expand the terms of ON Semiconductor's worldwide terms and conditions, specifically the warranty therein, which covers ON Semiconductor products.*



**Physical Dimensions** (continued)

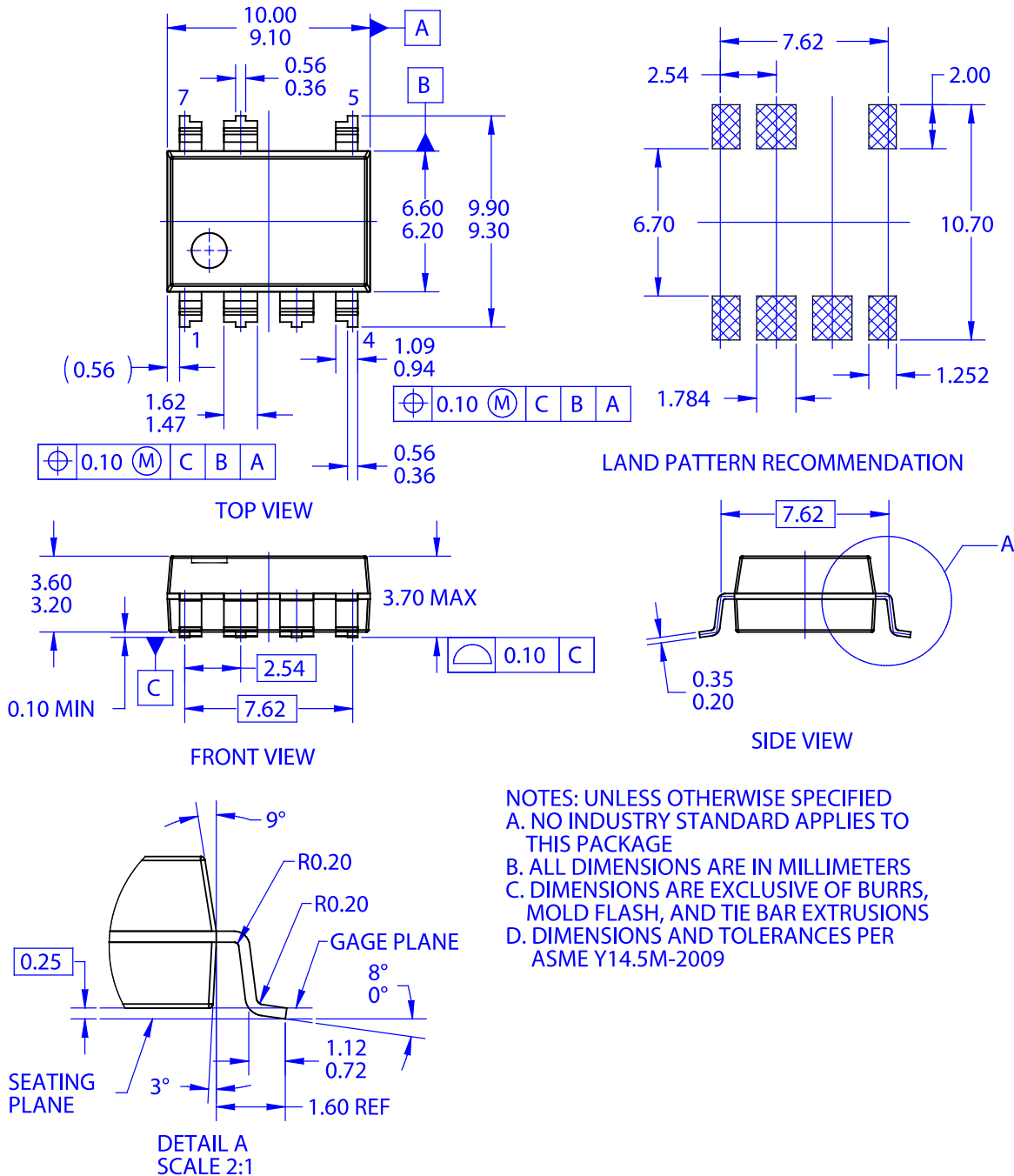

**Figure 33. 7-Lead, .300" Wide, Surface Mount Package (LSOP)**

Package drawings are provided as a service to customers considering ON Semiconductor components. Drawings may change in any manner without notice. Please note the revision and/or date on the drawing and contact an ON Semiconductor representative to verify or obtain the most recent revision. Package specifications do not expand the terms of ON Semiconductor's worldwide terms and conditions, specifically the warranty therein, which covers ON Semiconductor products.

ON Semiconductor and the ON Semiconductor logo are trademarks of Semiconductor Components Industries, LLC dba ON Semiconductor or its subsidiaries in the United States and/or other countries. ON Semiconductor owns the rights to a number of patents, trademarks, copyrights, trade secrets, and other intellectual property. A listing of ON Semiconductor's product/patent coverage may be accessed at [www.onsemi.com/site/pdf/Patent-Marking.pdf](http://www.onsemi.com/site/pdf/Patent-Marking.pdf). ON Semiconductor reserves the right to make changes without further notice to any products herein. ON Semiconductor makes no warranty, representation or guarantee regarding the suitability of its products for any particular purpose, nor does ON Semiconductor assume any liability arising out of the application or use of any product or circuit, and specifically disclaims any and all liability, including without limitation special, consequential or incidental damages. Buyer is responsible for its products and applications using ON Semiconductor products, including compliance with all laws, regulations and safety requirements or standards, regardless of any support or applications information provided by ON Semiconductor. "Typical" parameters which may be provided in ON Semiconductor data sheets and/or specifications can and do vary in different applications and actual performance may vary over time. All operating parameters, including "Typicals" must be validated for each customer application by customer's technical experts. ON Semiconductor does not convey any license under its patent rights nor the rights of others. ON Semiconductor products are not designed, intended, or authorized for use as a critical component in life support systems or any FDA Class 3 medical devices or medical devices with a same or similar classification in a foreign jurisdiction or any devices intended for implantation in the human body. Should Buyer purchase or use ON Semiconductor products for any such unintended or unauthorized application, Buyer shall indemnify and hold ON Semiconductor and its officers, employees, subsidiaries, affiliates, and distributors harmless against all claims, costs, damages, and expenses, and reasonable attorney fees arising out of, directly or indirectly, any claim of personal injury or death associated with such unintended or unauthorized use, even if such claim alleges that ON Semiconductor was negligent regarding the design or manufacture of the part. ON Semiconductor is an Equal Opportunity/Affirmative Action Employer. This literature is subject to all applicable copyright laws and is not for resale in any manner.

**PUBLICATION ORDERING INFORMATION**

**LITERATURE FULFILLMENT:**

Literature Distribution Center for ON Semiconductor  
 19521 E. 32nd Pkwy, Aurora, Colorado 80011 USA  
**Phone:** 303-675-2175 or 800-344-3860 Toll Free USA/Canada  
**Fax:** 303-675-2176 or 800-344-3867 Toll Free USA/Canada  
**Email:** [orderlit@onsemi.com](mailto:orderlit@onsemi.com)

**N. American Technical Support:** 800-282-9855 Toll Free  
 USA/Canada.  
**Europe, Middle East and Africa Technical Support:**  
 Phone: 421 33 790 2910  
**Japan Customer Focus Center**  
 Phone: 81-3-5817-1050

**ON Semiconductor Website:** [www.onsemi.com](http://www.onsemi.com)  
**Order Literature:** <http://www.onsemi.com/orderlit>  
 For additional information, please contact your local  
 Sales Representative

ON Semiconductor and  are trademarks of Semiconductor Components Industries, LLC dba ON Semiconductor or its subsidiaries in the United States and/or other countries. ON Semiconductor owns the rights to a number of patents, trademarks, copyrights, trade secrets, and other intellectual property. A listing of ON Semiconductor's product/patent coverage may be accessed at [www.onsemi.com/site/pdf/Patent-Marking.pdf](http://www.onsemi.com/site/pdf/Patent-Marking.pdf). ON Semiconductor reserves the right to make changes without further notice to any products herein. ON Semiconductor makes no warranty, representation or guarantee regarding the suitability of its products for any particular purpose, nor does ON Semiconductor assume any liability arising out of the application or use of any product or circuit, and specifically disclaims any and all liability, including without limitation special, consequential or incidental damages. Buyer is responsible for its products and applications using ON Semiconductor products, including compliance with all laws, regulations and safety requirements or standards, regardless of any support or applications information provided by ON Semiconductor. "Typical" parameters which may be provided in ON Semiconductor data sheets and/or specifications can and do vary in different applications and actual performance may vary over time. All operating parameters, including "Typicals" must be validated for each customer application by customer's technical experts. ON Semiconductor does not convey any license under its patent rights nor the rights of others. ON Semiconductor products are not designed, intended, or authorized for use as a critical component in life support systems or any FDA Class 3 medical devices or medical devices with a same or similar classification in a foreign jurisdiction or any devices intended for implantation in the human body. Should Buyer purchase or use ON Semiconductor products for any such unintended or unauthorized application, Buyer shall indemnify and hold ON Semiconductor and its officers, employees, subsidiaries, affiliates, and distributors harmless against all claims, costs, damages, and expenses, and reasonable attorney fees arising out of, directly or indirectly, any claim of personal injury or death associated with such unintended or unauthorized use, even if such claim alleges that ON Semiconductor was negligent regarding the design or manufacture of the part. ON Semiconductor is an Equal Opportunity/Affirmative Action Employer. This literature is subject to all applicable copyright laws and is not for resale in any manner.

## PUBLICATION ORDERING INFORMATION

### LITERATURE FULFILLMENT:

Literature Distribution Center for ON Semiconductor  
19521 E. 32nd Pkwy, Aurora, Colorado 80011 USA  
**Phone:** 303-675-2175 or 800-344-3860 Toll Free USA/Canada  
**Fax:** 303-675-2176 or 800-344-3867 Toll Free USA/Canada  
**Email:** [orderlit@onsemi.com](mailto:orderlit@onsemi.com)

**N. American Technical Support:** 800-282-9855 Toll Free  
USA/Canada  
**Europe, Middle East and Africa Technical Support:**  
Phone: 421 33 790 2910  
**Japan Customer Focus Center**  
Phone: 81-3-5817-1050

**ON Semiconductor Website:** [www.onsemi.com](http://www.onsemi.com)  
**Order Literature:** <http://www.onsemi.com/orderlit>  
For additional information, please contact your local  
Sales Representative