



Chipsmall Limited consists of a professional team with an average of over 10 year of expertise in the distribution of electronic components. Based in Hongkong, we have already established firm and mutual-benefit business relationships with customers from,Europe,America and south Asia,supplying obsolete and hard-to-find components to meet their specific needs.

With the principle of “Quality Parts,Customers Priority,Honest Operation,and Considerate Service”,our business mainly focus on the distribution of electronic components. Line cards we deal with include Microchip,ALPS,ROHM,Xilinx,Pulse,ON,Everlight and Freescale. Main products comprise IC,Modules,Potentiometer,IC Socket,Relay,Connector.Our parts cover such applications as commercial,industrial, and automotives areas.

We are looking forward to setting up business relationship with you and hope to provide you with the best service and solution. Let us make a better world for our industry!



Contact us

Tel: +86-755-8981 8866 Fax: +86-755-8427 6832

Email & Skype: info@chipsmall.com Web: www.chipsmall.com

Address: A1208, Overseas Decoration Building, #122 Zhenhua RD., Futian, Shenzhen, China



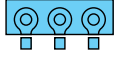

RING TONGUE TERMINAL

Terminals mounted on transparent tape can be crimped efficiently by a specially-designed automatic crimping machine. In addition, high uniform crimping is ensured since the terminals are crimped at a fixed position.

To identify tape-mounted terminals, "TOR" is affixed to the parts numbers of non-taped terminals.

Ordering example: "0.5-2 TOR".

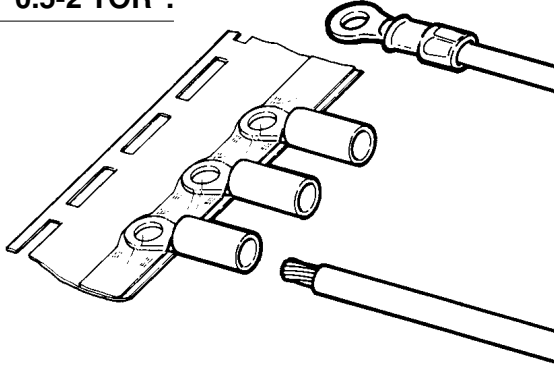

| Order No. | Q'ty/reel | Die set No. | | |
|-----------------|-----------|-------------|-------|----------|
| 0.5-2 TOR | 1,000 | 3H-2622 | | |
| 0.5-3 TOR | | | | |
| 0.5-3.7 TOR | | | | |
| 0.5-4 TOR | | | | |
| V0.5-3 TOR | 1,000 | 3V-2622N | | |
| V0.5-3.7 TOR | | | | |
| V0.5-4 TOR | | | | |
| V0.5-5 TOR | | | | |
| FV0.5-3 TOR | 1,000 | 3V-2622N | | |
| FV0.5-3.7 TOR | | | | |
| FV0.5-4 TOR | | | | |
| FV0.5-5 TOR | | | | |
| N0.5-3 TOR | 1,000 | 3V-2622N | | |
| FVD0.5-3 TOR | 1,000 | 3V-2622N | | |
| FVD0.5-4 TOR | 1,000 | 3H-2216 | | |
| 1.25-3 TOR | | | | |
| 1.25-3.7 TOR | | | | |
| 1.25-MS3 TOR | | | | |
| 1.25-M3 TOR | | | | |
| 1.25-L3 TOR | | | | |
| 1.25-M4 TOR | | | | |
| 1.25-4 TOR | | | | |
| 1.25-5 TOR | | | | |
| 1.25-6 TOR | | | | |
| 1.25-8 TOR | | | | |
| 1.25-10 TOR | | | | |
| V1.25-3 TOR | | | 1,000 | 3V-2216N |
| V1.25-3.7 TOR | | | | |
| V1.25-MS3 TOR | | | | |
| V1.25-L3 TOR | | | | |
| V1.25-M4 TOR | | | | |
| V1.25-4 TOR | | | | |
| V1.25-5 TOR | 1,000 | 3V-2216N | | |
| V1.25-6 TOR | | | | |
| N1.25-3.7 TOR | | | | |
| N1.25-MS3 TOR | | | | |
| N1.25-M3 TOR | | | | |
| N1.25-M4 TOR | | | | |
| FN1.25-3 TOR | 1,000 | 3V-2216N | | |
| FN1.25-4 TOR | 1,000 | 3V-2216D | | |
| VD1.25-4 TOR | | | | |
| VD1.25-5 TOR | | | | |
| VD1.25-6 TOR | | | | |
| VD1.25-10 TOR | | | | |
| FVD1.25-3 TOR | | | 1,000 | 3V-2216D |
| FVD1.25-3.7 TOR | | | | |
| FVD1.25-MS3 TOR | | | | |
| FVD1.25-M3 TOR | | | | |
| FVD1.25-M4 TOR | | | | |
| FVD1.25-4 TOR | | | | |
| FVD1.25-5 TOR | 1,000 | 3V-2216D | | |
| FVD1.25-6 TOR | | | | |

Note:1) Delivery lead times may vary depending on the product.
Contact JST for details.

| Order No. | Q'ty/reel | Die set No. | | |
|-----------------|-----------|-------------|-------|----------|
| FV1.25-3 TOR | 1,000 | 3V-2216N | | |
| FV1.25-3.7 TOR | | | | |
| FV1.25-MS3 TOR | | | | |
| FV1.25-M3 TOR | | | | |
| FV1.25-L3 TOR | | | | |
| FV1.25-M4 TOR | | | | |
| FV1.25-4 TOR | | | | |
| FV1.25-5 TOR | | | | |
| FV1.25-6 TOR | | | | |
| FV1.25-8 TOR | | | | |
| FV1.25-10 TOR | | | | |
| FVX1.25-5 TOR | | | 1,000 | 3V-2216N |
| FVX1.25-10 TOR | | | 1,000 | 3V-2216N |
| FVL1.25-3 TOR | | | | |
| FVL1.25-3.7 TOR | | | | |
| FVL1.25-MS3 TOR | | | | |
| FVL1.25-M3 TOR | | | | |
| FVL1.25-M4 TOR | | | | |
| FVL1.25-4 TOR | 1,000 | 3V-2216N | | |
| FVL1.25-5 TOR | | | | |
| N1.25-3.7 TOR | | | | |
| N1.25-MS3 TOR | | | | |
| N1.25-M3 TOR | | | | |
| N1.25-M4 TOR | | | | |
| FN1.25-3 TOR | 1,000 | 3V-2216N | | |
| FN1.25-4 TOR | 1,000 | 3V-2216D | | |
| VD1.25-4 TOR | | | | |
| VD1.25-5 TOR | | | | |
| VD1.25-6 TOR | | | | |
| VD1.25-10 TOR | | | | |
| FVD1.25-3 TOR | | | 1,000 | 3V-2216D |
| FVD1.25-3.7 TOR | | | | |
| FVD1.25-MS3 TOR | | | | |
| FVD1.25-M3 TOR | | | | |
| FVD1.25-M4 TOR | | | | |
| FVD1.25-4 TOR | | | | |
| FVD1.25-5 TOR | 1,000 | 3V-2216D | | |
| FVD1.25-6 TOR | | | | |

Note:1) Delivery lead times may vary depending on the product.
Contact JST for details.



| Order No. | Q'ty/reel | Die set No. |
|----------------|-----------|-------------|
| FND1.25-2 TOR | 1,000 | 3V-2216D |
| FND1.25-M3 TOR | | |
| FND1.25-5 TOR | | |
| FND1.25-6 TOR | | |
| FND1.25-8 TOR | | |
| FND1.25-10 TOR | | |
| 2-S3.3 TOR | 1,000 | 3H-1614 |
| 2-S3 TOR | | |
| 2-MS3 TOR | | |
| 2-M3 TOR | | |
| 2-3 TOR | | |
| 2-M4 TOR | | |
| 2-4 TOR | | |
| 2-M5 TOR | | |
| 2-5 TOR | | |
| 2-6 TOR | | |
| 2-8 TOR | | |
| 2-9 TOR | | |
| V2-S3 TOR | 1,000 | 3V-1614N |
| V2-MS3 TOR | | |
| V2-M3 TOR | | |
| V2-3 TOR | | |
| V2-M4 TOR | | |
| V2-P4 TOR | | |
| V2-4 TOR | | |
| V2-M5 TOR | | |
| V2-5 TOR | | |
| V2-6 TOR | | |
| V2-8 TOR | | |
| FV2-S3.3 TOR | 1,000 | 3V-1614N |
| FV2-S3 TOR | | |
| FV2-MS3 TOR | | |
| FV2-M3 TOR | | |
| FV2-3 TOR | | |
| FV2-M4 TOR | | |
| FV2-P4 TOR | | |
| FV2-4 TOR | | |
| FV2-M5 TOR | | |
| FV2-5 TOR | | |
| FV2-6 TOR | | |
| FV2-8 TOR | | |
| FVX2-P3.5 TOR | 1,000 | 3V-1614N |
| FVL2-S3.3 TOR | 1,000 | 3V-1614N |
| FVL2-MS3 TOR | | |
| FVL2-M3 TOR | | |
| FVL2-P3.5 TOR | | |
| FVL2-3 TOR | | |
| FVL2-M4 TOR | | |
| FVL2-4 TOR | | |
| FVL2-M5 TOR | | |
| FVL2-5 TOR | | |
| FVL2-6 TOR | | |
| N2-M4 TOR | 1,000 | 3V-1614N |

Note:1) Delivery lead times may vary depending on the product.
Contact JST for details.

| Order No. | Q'ty/reel | Die set No. |
|---------------|-----------|-------------|
| FVD2-S3 TOR | 1,000 | 3V-1614D |
| FVD2-M3 TOR | | |
| FVD2-M4 TOR | | |
| FVD2-4 TOR | | |
| FVD2-M5 TOR | | |
| FVD2-5 TOR | | |
| FVD2-6 TOR | | |
| FVD2-8 TOR | | |
| FND2-S3 TOR | | |
| FND2-M3 TOR | | |
| FND2-8 TOR | 1,000 | 3H-1210N |
| 5.5-S3 TOR | | |
| 5.5-3 TOR | | |
| 5.5-S4 TOR | | |
| 5.5-4 TOR | | |
| 5.5-5 TOR | | |
| 5.5-6 TOR | 500 | |
| 5.5-S6 TOR | | |
| 5.5-8 TOR | 500 | 3V-1210N |
| 5.5-9 TOR | | |
| V5.5-S3 TOR | | |
| V5.5-S4 TOR | | |
| V5.5-4 TOR | | |
| V5.5-5 TOR | | |
| V5.5-6 TOR | 500 | 3V-1210N |
| V5.5-8 TOR | | |
| FV5.5-S3 TOR | | |
| FV5.5-3 TOR | | |
| FV5.5-S4 TOR | | |
| FV5.5-4 TOR | | |
| FV5.5-5 TOR | 500 | 3V-1210N |
| FV5.5-6 TOR | | |
| FV5.5-S6 TOR | | |
| FV5.5-S8 TOR | | |
| FVX5.5-S4 TOR | | |
| FVX5.5-5 TOR | | |
| FVX5.5-8 TOR | 500 | 3V-1210N |
| FVL5.5-S3 TOR | | |
| FVL5.5-S4 TOR | | |
| FVL5.5-4 TOR | | |
| FVL5.5-5 TOR | | |
| FVL5.5-6 TOR | | |
| N5.5-S4 TOR | 500 | 3V-1210N |
| N5.5-4 TOR | | |
| N5.5-5 TOR | | |
| N5.5-8 TOR | | |
| VD5.5-S3 TOR | 500 | 3V-1210N |
| VD5.5-S4 TOR | | |
| VD5.5-4 TOR | | |
| VD5.5-5 TOR | | |
| FVD5.5-S4 TOR | 500 | 3V-1210N |
| FVD5.5-4 TOR | | |
| FVD5.5-5 TOR | | |
| FVD5.5-6 TOR | | |
| FVD5.5-S8 TOR | | |
| FND5.5-10 TOR | | |

Note:1) Delivery lead times may vary depending on the product.
Contact JST for details.

Tape-on terminals/splices

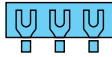

SPADE TONGUE TERMINAL

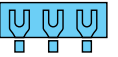

| Order No. | Q'ty/reel | Die set No. | | |
|------------------|-----------|-------------|-------|----------|
| 1.25-B3A TOR | 1,000 | 3H-2216 | | |
| 1.25-YS3A TOR | | | | |
| 1.25-S3A TOR | | | | |
| 1.25-N3A TOR | | | | |
| 1.25-M3A TOR | | | | |
| 1.25-YS4A TOR | | | | |
| 1.25-S4A TOR | | | | |
| 1.25-4A TOR | | | | |
| 1.25-5A TOR | | | | |
| 1.25-M5A TOR | | | | |
| 1.25-C3A TOR | | | | |
| V1.25-B3A TOR | | | 1,000 | 3V-2216N |
| V1.25-YS3A TOR | | | | |
| V1.25-S3A TOR | | | | |
| V1.25-YS4A TOR | | | | |
| V1.25-S4A TOR | | | | |
| V1.25-4A TOR | | | | |
| V1.25-5A TOR | 1,000 | 3V-2216N | | |
| FV1.25-YS3A TOR | | | | |
| FV1.25-S3A TOR | | | | |
| FV1.25-YS4A TOR | | | | |
| FV1.25-S4A TOR | 1,000 | 3V-2216N | | |
| FN1.25-S4A TOR | 1,000 | 3V-2216N | | |
| FVL1.25-YS3A TOR | 1,000 | 3V-2216N | | |
| FVL1.25-P3A TOR | | | | |
| FVL1.25-S4A TOR | | | | |

Note:1) Delivery lead times may vary depending on the product.
Contact JST for details.

| Order No. | Q'ty/reel | Die set No. |
|------------------|-----------|-------------|
| VD1.25-4A TOR | 1,000 | 3V-2216D |
| FVD1.25-B3A TOR | 1,000 | 3V-2216D |
| FVD1.25-YS3A TOR | | |
| FVD1.25-S3A TOR | | |
| FVD1.25-S4A TOR | | |
| FND1.25-5A TOR | 1,000 | 3H-2216D |
| 2-N3A TOR | 1,000 | 3H-1614 |
| 2-YS3A TOR | | |
| 2-YS4A TOR | | |
| 2-S4A TOR | | |
| 2-4A TOR | | |
| 2-5A TOR | | |
| V2-YS3A TOR | 1,000 | 3V-1614N |
| V2-4A TOR | 1,000 | 3V-1614N |
| FV2-YS3A TOR | | |
| FV2-S3A TOR | | |
| FV2-4A TOR | | |
| FV2-5A TOR | 1,000 | 3V-1614D |
| FVD2-4A TOR | 1,000 | 3H-1210N |
| 5.5-S3A TOR | | |
| 5.5-S4A TOR | | |
| 5.5-5A TOR | 500 | 3V-1210N |
| FV5.5-S3A TOR | | |
| FV5.5-5A TOR | | |
| FVL5.5-S3A TOR | 500 | 3V-1210N |

Note:1) Delivery lead times may vary depending on the product.
Contact JST for details.

Tape-on terminals/splices



FLANGED SPADE TONGUE TERMINAL



| Order No. | Q'ty/reel | Die set No. |
|-----------------|-----------|-------------|
| 1.25-S3B TOR | 1,000 | 3H-2216 |
| 1.25-S4B TOR | | |
| V1.25-S3B TOR | 1,000 | 3V-2216N |
| V1.25-S4B TOR | | |
| FND1.25-S3B TOR | 1,000 | 3V-2216D |
| 2-S4B TOR | 1,000 | 3H-1614 |
| 2-T4B TOR | | |
| FV2-S3B TOR | 1,000 | 3V-1614N |
| N2-T4B TOR | 1,000 | 3V-1614N |

Note:1) Delivery lead times may vary depending on the product.
Contact JST for details.

| Order No. | Q'ty/reel | Die set No. |
|----------------|-----------|-------------|
| FVD2-T3B TOR | 1,000 | 3V-1614D |
| 5.5-S4B TOR | 1,000 | 3H-1210N |
| 5.5-S5B TOR | | |
| 5.5-5B TOR | | |
| V5.5-S4B TOR | 500 | 3V-1210N |
| FV5.5-3B TOR | 500 | 3V-1210N |
| FV5.5-4B TOR | | |
| N5.5-S4B TOR | 500 | 3V-1210N |
| FVX5.5-S4B TOR | 500 | 3V-1210N |

Note:1) Delivery lead times may vary depending on the product.
Contact JST for details.

Tape-on terminals/splices

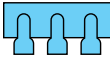

CLOSED-END SPLICE

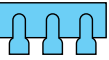

| Order No. | Q'ty/reel | Die set No. |
|------------|-----------|-------------|
| 1-SD TOR | 500 | 3S-2218D |
| 2-SD TOR | | 3S-1614D |
| 5.5-SD TOR | 400 | 3S-1210D |
| CE1 TOR | 500 | 3S-2218D |
| CE2 TOR | | 3S-1614D |
| CE5 TOR | 400 | 3S-1210D |

Note:1) Delivery lead times may vary depending on the product.
Contact JST for details.

Tape-on terminals/splices

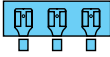

QUICK DISCONNECT TERMINAL *Vinyl-insulated with copper sleeve*

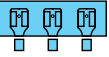

| Order No. | Q'ty/reel | Die set No. |
|----------------------|-----------|-------------|
| FVDDF1.25-110A-5 TOR | 1,000 | 3V-2216N |
| FVDDF1.25-110A-8 TOR | | |
| FVDDF1.25-187A-5 TOR | | |
| FVDDF1.25-187A-8 TOR | | |
| FVDDF2-187A-5 TOR | 1,000 | 3V-1614N |
| FVDDF2-205A-8 TOR | | |
| FVDDF1.25-250A TOR | 1,000 | 3V-2216N |
| FVDDF2-250A TOR | 1,000 | 3V-1614N |
| FVDDF5.5-250A TOR | 500 | 3V-1210N |
| FVDDF1.25-250B TOR | 1,000 | 3V-2216N |
| FVDDF2-250B TOR | 1,000 | 3V-1614N |
| FVDDF5.5-250B TOR | 500 | 3V-1210N |
| FVZDF1.25-110A-5 TOR | 1,000 | 3V-2216N |
| FVZDF1.25-110A-8 TOR | | |
| FVZDF1.25-187A-5 TOR | | |
| FVZDF1.25-187A-8 TOR | | |
| FVZDF1.25-250A TOR | 1,000 | 3V-1614N |
| FVZDF2-187A-5 TOR | | |
| FVZDF2-187A-8 TOR | | |
| FVZDF2-250A TOR | | |

Note:1) Delivery lead times may vary depending on the product.
Contact JST for details.

| Order No. | Q'ty/reel | Die set No. |
|-----------------------|-----------|-------------|
| LVDDF1.25-187A-5 TOR | 500 | 3V-2216N |
| LVDDF1.25-187A-8 TOR | | |
| LVDDF2-187A-5 TOR | 500 | 3V-1614N |
| LVDDF2-187A-8 TOR | | |
| LVDDF1.25-250A TOR | 500 | 3V-2216N |
| LVDDF2-250A TOR | 500 | 3V-1614N |
| LVDDF5.5-250A TOR | 500 | 3V-1210N |
| FLVDDF1.25-187A-5 TOR | 500 | 3V-2216N |
| FLVDDF1.25-187A-8 TOR | | |
| FLVDDF2-187A-5 TOR | 500 | 3V-1614N |
| FLVDDF2-187A-8 TOR | | |
| FLVDDF1.25-250A TOR | 500 | 3V-2216N |
| FLVDDF2-250A TOR | 500 | 3V-1614N |
| FLVZDF1.25-187A-5 TOR | 500 | 3V-2216N |
| FLVZDF1.25-187A-8 TOR | | |
| FLVZDF2-187A-5 TOR | 500 | 3V-1614N |
| FLVZDF2-187A-8 TOR | | |
| FLVZDF1.25-250A TOR | 500 | 3V-2216N |
| FLVZDF2-250A TOR | 500 | 3V-1614N |
| FVDDM1.25-250 TOR | 1,000 | 3V-2216N |
| FVDDM2-250 TOR | 1,000 | 3V-1614N |

Note:1) Delivery lead times may vary depending on the product.
Contact JST for details.