



Chipsmall Limited consists of a professional team with an average of over 10 year of expertise in the distribution of electronic components. Based in Hongkong, we have already established firm and mutual-benefit business relationships with customers from,Europe,America and south Asia,supplying obsolete and hard-to-find components to meet their specific needs.

With the principle of “Quality Parts,Customers Priority,Honest Operation,and Considerate Service”,our business mainly focus on the distribution of electronic components. Line cards we deal with include Microchip,ALPS,ROHM,Xilinx,Pulse,ON,Everlight and Freescale. Main products comprise IC,Modules,Potentiometer,IC Socket,Relay,Connector.Our parts cover such applications as commercial,industrial, and automotives areas.

We are looking forward to setting up business relationship with you and hope to provide you with the best service and solution. Let us make a better world for our industry!



## Contact us

Tel: +86-755-8981 8866 Fax: +86-755-8427 6832

Email & Skype: info@chipsmall.com Web: www.chipsmall.com

Address: A1208, Overseas Decoration Building, #122 Zhenhua RD., Futian, Shenzhen, China



Tape-on terminals/splices

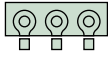

# RING TONGUE TERMINAL

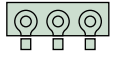

Terminals mounted on transparent tape can be crimped efficiently by a specially-designed automatic crimping machine. In addition, high uniform crimping is ensured since the terminals are crimped at a fixed position. To identify tape-mounted terminals, "TOR" is affixed to the parts numbers of non-taped terminals.

**Ordering example: "0.5-2 TOR".**

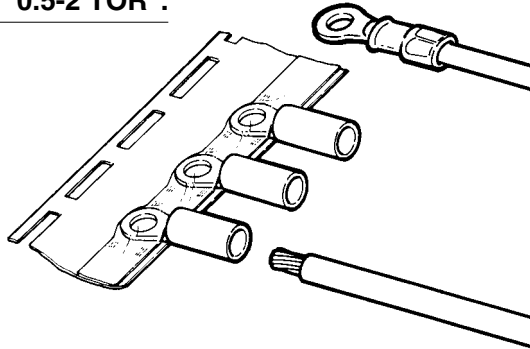

Order No.	Q'ty/reel	Die set No.		
0.5-2 TOR	1,000	3H-2622		
0.5-3 TOR				
0.5-3.7 TOR				
0.5-4 TOR				
V0.5-3 TOR	1,000	3V-2622N		
V0.5-3.7 TOR				
V0.5-4 TOR				
V0.5-5 TOR				
FV0.5-3 TOR	1,000	3V-2622N		
FV0.5-3.7 TOR				
FV0.5-4 TOR				
FV0.5-5 TOR				
N0.5-3 TOR	1,000	3V-2622N		
FVD0.5-3 TOR	1,000	3V-2622N		
FVD0.5-4 TOR				
1.25-3 TOR	1,000	3H-2216		
1.25-3.7 TOR				
1.25-MS3 TOR				
1.25-M3 TOR				
1.25-L3 TOR				
1.25-M4 TOR				
1.25-4 TOR				
1.25-5 TOR				
1.25-6 TOR				
1.25-8 TOR				
1.25-10 TOR				
V1.25-3 TOR			1,000	3V-2216N
V1.25-3.7 TOR				
V1.25-MS3 TOR				
V1.25-L3 TOR				
V1.25-M4 TOR				
V1.25-4 TOR				
V1.25-5 TOR	1,000	3V-2216N		
V1.25-6 TOR				
V1.25-8 TOR				
V1.25-10 TOR				

Order No.	Q'ty/reel	Die set No.
FV1.25-3 TOR	1,000	3V-2216N
FV1.25-3.7 TOR		
FV1.25-MS3 TOR		
FV1.25-M3 TOR		
FV1.25-L3 TOR		
FV1.25-M4 TOR		
FV1.25-4 TOR		
FV1.25-5 TOR		
FV1.25-6 TOR		
FV1.25-8 TOR		
FV1.25-10 TOR	1,000	3V-2216N
FVX1.25-5 TOR		
FVX1.25-10 TOR	1,000	3V-2216N
N1.25-3.7 TOR		
N1.25-MS3 TOR		
N1.25-M3 TOR		
N1.25-M4 TOR	1,000	3V-2216N
FN1.25-3 TOR		
FN1.25-4 TOR	1,000	3V-2216D
VD1.25-4 TOR		
VD1.25-5 TOR		
VD1.25-6 TOR		
VD1.25-10 TOR	1,000	3V-2216D
FVD1.25-3 TOR		
FVD1.25-3.7 TOR		
FVD1.25-MS3 TOR		
FVD1.25-M3 TOR		
FVD1.25-M4 TOR		
FVD1.25-4 TOR	1,000	3V-2216D
FVD1.25-5 TOR		
FVD1.25-6 TOR		
FND1.25-2 TOR		
FND1.25-M3 TOR	1,000	3V-2216D
FND1.25-5 TOR		
FND1.25-6 TOR		
FND1.25-8 TOR		
FND1.25-10 TOR		

Order No.	Q'ty/reel	Die set No.
2-S3.3 TOR	1,000	3H-1614
2-S3 TOR		
2-MS3 TOR		
2-M3 TOR		
2-3 TOR		
2-M4 TOR		
2-4 TOR		
2-M5 TOR		
2-5 TOR		
2-6 TOR		
2-8 TOR	1,000	3V-1614N
2-9 TOR		
V2-S3 TOR		
V2-MS3 TOR		
V2-M3 TOR	1,000	3V-1614N
V2-3 TOR		
V2-M4 TOR		
V2-P4 TOR		
V2-4 TOR		
V2-M5 TOR		
V2-5 TOR		
V2-6 TOR		
V2-8 TOR	1,000	3V-1614N
FV2-S3.3 TOR		
FV2-S3 TOR		
FV2-MS3 TOR		
FV2-M3 TOR		
FV2-3 TOR		
FV2-M4 TOR	1,000	3V-1614N
FV2-P4 TOR		
FV2-4 TOR		
FV2-M5 TOR		
FV2-5 TOR	1,000	3V-1614N
FV2-6 TOR		
FV2-8 TOR		
FVX2-P3.5 TOR		
N2-M4 TOR	1,000	3V-1614N

Note:1) Delivery lead times may vary depending on the product. Contact JST for details.

Tape-on terminals/splices

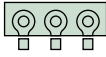

# RING TONGUE TERMINAL

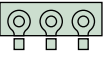

Order No.	Q'ty/reel	Die set No.
FVD2-S3 TOR	1,000	3V-1614D
FVD2-M3 TOR		
FVD2-M4 TOR		
FVD2-4 TOR		
FVD2-M5 TOR		
FVD2-5 TOR		
FVD2-6 TOR		
FVD2-8 TOR		
FND2-S3 TOR	1,000	3V-1614D
FND2-M3 TOR		
FND2-8 TOR		
5.5-S3 TOR	1,000	3H-1210N
5.5-3 TOR		
5.5-S4 TOR		
5.5-4 TOR		
5.5-5 TOR		
5.5-6 TOR		
5.5-S6 TOR	500	
5.5-8 TOR		
5.5-9 TOR		

Order No.	Q'ty/reel	Die set No.		
V5.5-S3 TOR	500	3V-1210N		
V5.5-S4 TOR				
V5.5-4 TOR				
V5.5-5 TOR				
V5.5-6 TOR				
V5.5-8 TOR				
FV5.5-S3 TOR			500	3V-1210N
FV5.5-3 TOR				
FV5.5-S4 TOR				
FV5.5-4 TOR				
FV5.5-5 TOR	500	3V-1210N		
FV5.5-6 TOR				
FV5.5-S6 TOR				
FV5.5-S8 TOR				
FVX5.5-S4 TOR	500	3V-1210N		
FVX5.5-5 TOR				
FVX5.5-8 TOR				
N5.5-S4 TOR	500	3V-1210N		
N5.5-4 TOR				
N5.5-5 TOR				
N5.5-8 TOR				

Order No.	Q'ty/reel	Die set No.
VD5.5-S3 TOR	500	3V-1210N
VD5.5-S4 TOR		
VD5.5-4 TOR		
VD5.5-5 TOR		
FVD5.5-S4 TOR	500	3V-1210N
FVD5.5-4 TOR		
FVD5.5-5 TOR		
FVD5.5-6 TOR		
FVD5.5-S8 TOR	500	3V-1210N
FND5.5-10 TOR		

Note:1) Delivery lead times may vary depending on the product. Contact JST for details.

Tape-on terminals/splices

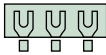

# SPADE TONGUE TERMINAL

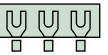

Order No.	Q'ty/reel	Die set No.
1.25-B3A TOR	1,000	3H-2216
1.25-YS3A TOR		
1.25-S3A TOR		
1.25-N3A TOR		
1.25-M3A TOR		
1.25-YS4A TOR		
1.25-S4A TOR		
1.25-4A TOR		
1.25-5A TOR		
1.25-M5A TOR		
1.25-C3A TOR		
V1.25-B3A TOR		
V1.25-YS3A TOR		
V1.25-S3A TOR		
V1.25-YS4A TOR		
V1.25-S4A TOR		
V1.25-4A TOR		
V1.25-5A TOR		

Order No.	Q'ty/reel	Die set No.
FV1.25-YS3A TOR	1,000	3V-2216N
FV1.25-S3A TOR		
FV1.25-YS4A TOR		
FV1.25-S4A TOR		
FN1.25-S4A TOR	1,000	3V-2216N
FVD1.25-B3A TOR	1,000	3V-2216D
FVD1.25-YS3A TOR		
FVD1.25-S3A TOR		
FVD1.25-S4A TOR		
FND1.25-5A TOR	1,000	3H-2216D
2-N3A TOR	1,000	3H-1614
2-YS3A TOR		
2-YS4A TOR		
2-S4A TOR		
2-4A TOR		
2-5A TOR		

Order No.	Q'ty/reel	Die set No.
V2-YS3A TOR	1,000	3V-1614N
V2-4A TOR		
FV2-YS3A TOR	1,000	3V-1614N
FV2-S3A TOR		
FV2-4A TOR		
FV2-5A TOR	1,000	3V-2216D
VD1.25-4A TOR		
FVD2-4A TOR	1,000	3V-1614D
5.5-S3A TOR	1,000	3H-1210N
5.5-S4A TOR		
5.5-5A TOR		
FV5.5-S3A TOR	500	3V-1210N
FV5.5-5A TOR		

Note:1) Delivery lead times may vary depending on the product. Contact JST for details.

Tape-on terminals/splices

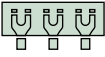

# FLANGED SPADE TONGUE TERMINAL

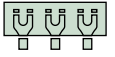

Order No.	Q'ty/reel	Die set No.
1.25-S3B TOR	1,000	3H-2216
1.25-S4B TOR		
V1.25-S3B TOR	1,000	3V-2216N
V1.25-S4B TOR		
FND1.25-S3B TOR	1,000	3V-2216D
2-S4B TOR	1,000	3H-1614
2-T4B TOR		
FV2-S3B TOR	1,000	3V-1614N
N2-T4B TOR	1,000	3V-1614N

Order No.	Q'ty/reel	Die set No.
FVD2-T3B TOR	1,000	3V-1614D
5.5-S4B TOR	1,000	3H-1210N
5.5-S5B TOR		
5.5-5B TOR		
V5.5-S4B TOR	500	3V-1210N
FV5.5-3B TOR	500	3V-1210N
FV5.5-4B TOR		
N5.5-S4B TOR	500	3V-1210N
FVX5.5-S4B TOR	500	3V-1210N

Note:1) Delivery lead times may vary depending on the product. Contact JST for details.

Tape-on terminals/splices

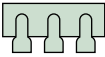

# CLOSED-END SPLICE

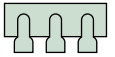

Order No.	Q'ty/reel	Die set No.
1-SD TOR	500	3S-2218D
2-SD TOR		3S-1614D
5.5-SD TOR	400	3S-1210D
CE1 TOR	500	3S-2218D
CE2 TOR		3S-1614D
CE5 TOR	400	3S-1210D

Note:1) Delivery lead times may vary depending on the product.  
Contact JST for details.

Tape-on terminals/splices

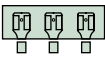

# QUICK DISCONNECT TERMINAL *Vinyl-insulated with copper sleeve*

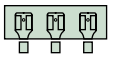

Order No.	Q'ty/reel	Die set No.
FVDDF1.25-110A-5 TOR	1,000	3V-2216N
FVDDF1.25-110A-8 TOR		
FVDDF1.25-187A-5 TOR		
FVDDF1.25-187A-8 TOR		
FVDDF2-187A-5 TOR	1,000	3V-1614N
FVDDF2-205A-8 TOR		
FVDDF1.25-250A TOR	1,000	3V-2216N
FVDDF2-250A TOR	1,000	3V-1614N
FVDDF5.5-250A TOR	500	3V-1210N
FVDDF1.25-250B TOR	1,000	3V-2216N
FVDDF2-250B TOR	1,000	3V-1614N
FVDDF5.5-250B TOR	500	3V-1210N
FVZDF1.25-110A-5 TOR	1,000	3V-2216N
FVZDF1.25-110A-8 TOR		
FVZDF1.25-187A-5 TOR		
FVZDF1.25-187A-8 TOR		
FVZDF1.25-250A TOR		
FVZDF2-187A-5 TOR	1,000	3V-1614N
FVZDF2-187A-8 TOR		
FVZDF2-250A TOR		

Order No.	Q'ty/reel	Die set No.
LVDDF1.25-187A-5 TOR	500	3V-2216N
LVDDF1.25-187A-8 TOR		
LVDDF2-187A-5 TOR	500	3V-1614N
LVDDF2-187A-8 TOR		
LVDDF1.25-250A TOR	500	3V-2216N
LVDDF2-250A TOR	500	3V-1614N
LVDDF5.5-250A TOR	500	3V-1210N
FLVDDF1.25-187A-5 TOR	500	3V-2216N
FLVDDF1.25-187A-8 TOR		
FLVDDF2-187A-5 TOR	500	3V-1614N
FLVDDF2-187A-8 TOR		
FLVDDF1.25-250A TOR	500	3V-2216N
FLVDDF2-250A TOR	500	3V-1614N
FLVZDF1.25-187A-5 TOR	500	3V-2216N
FLVZDF1.25-187A-8 TOR		
FLVZDF2-187A-5 TOR	500	3V-1614N
FLVZDF2-187A-8 TOR		
FLVZDF1.25-250A TOR	500	3V-2216N
FLVZDF2-250A TOR	500	3V-1614N
FVDDM1.25-250 TOR	1,000	3V-2216N
FVDDM2-250 TOR	1,000	3V-1614N

Note:1) Delivery lead times may vary depending on the product. Contact JST for details.