



Chipsmall Limited consists of a professional team with an average of over 10 year of expertise in the distribution of electronic components. Based in Hongkong, we have already established firm and mutual-benefit business relationships with customers from,Europe,America and south Asia,supplying obsolete and hard-to-find components to meet their specific needs.

With the principle of “Quality Parts,Customers Priority,Honest Operation,and Considerate Service”,our business mainly focus on the distribution of electronic components. Line cards we deal with include Microchip,ALPS,ROHM,Xilinx,Pulse,ON,Everlight and Freescale. Main products comprise IC,Modules,Potentiometer,IC Socket,Relay,Connector.Our parts cover such applications as commercial,industrial, and automotives areas.

We are looking forward to setting up business relationship with you and hope to provide you with the best service and solution. Let us make a better world for our industry!



Contact us

Tel: +86-755-8981 8866 Fax: +86-755-8427 6832

Email & Skype: info@chipsmall.com Web: www.chipsmall.com

Address: A1208, Overseas Decoration Building, #122 Zhenhua RD., Futian, Shenzhen, China



REVISION CR

NOTES:

1. $\text{\textcircled{C}}$ REPRESENTS A CRITICAL DIMENSION.
2. MINIMUM PUSHOUT FORCE SHALL BE 1 LB.
3. GOLD AREA TO APPEAR ON POST.
4. TAILS TO BE SHEARED TO DIMENSION SHOWN. (FOR HAND TOOLING ONLY)
5. TO BE VALID ALL PART NUMBERS MUST MEET THE FOLLOWING PARAMETERS: THE BOARD SPACE RANGE, POST HEIGHT MIN. AND BOARD + POST COMBINATION FOR EACH STYLE.
6. MAXIMUM BURR: .003[0.08] ON CUT TAIL.
7. MAXIMUM CUT FLASH TO BE .010[0.25] ON CRITICAL AREAS AS SHOWN.
8. AVAILABLE ONLY W/BOARD SPACE .215[5.46] TOP .610[15.49].
9. PARTS TO BE ASSEMBLED WITH ALIGNMENT HOLES (IN BODY) FACING THE TAILS
10. LOWER BODY MAY BE BLACK OR WHITE.
11. FILL BODY SO THAT THE LEAD IN OF THE CORE IS ON THE TAIL SIDE.
12. MAXIMUM HEIGHT VARIATION BETWEEN ROWS: .005[0.13].
13. FOR ADDED MECHANICAL STABILITY, SAMTEC RECOMMENDS MECHANICAL BOARD SPACERS BE USED IN APPLICATIONS WITH GOLD OR SELECTIVE GOLD PLATED CONNECTORS. CONTACT IPG@SAMTEC.COM FOR MORE INFORMATION.
14. SUB-FW-50-03-XX-D-280-015 TO USE T-1S15-08, SUB-FW-50-05-XX-D-400-065 TO USE T-1S15-03.

PATENT NUMBERS
5713755 / 5961339

FW-XX-XX-XX-D-XXX-XXX-XX

DO NOT SCALE FROM THIS PRINT

POSITION SPEC
No. OF POS PER ROW
-02 THRU -50

LEAD STYLE
-03: USE T-1S15-XX-X
-05: USE T-1S15-XX-X
(SEE TABLE 1)

PLATING
-G: 10 μ " GOLD IN CONTACT AREA,
3 μ " GOLD ON TAIL
-F: 3 μ " SELECTIVE GOLD IN CONTACT AREA,
MATTE TIN ON TAIL
-L: 10 μ " SELECTIVE GOLD IN CONTACT AREA,
MATTE TIN TAIL
-H: 30 μ " GOLD IN CONTACT AREA,
3 μ " GOLD ON TAIL
-LM: 10 μ " SELECTIVE GOLD IN CONTACT AREA,
MATTE TIN TAIL
-FM: 3 μ " SELECTIVE GOLD IN CONTACT AREA,
MATTE TIN ON TAIL
-S: 30 μ " SELECTIVE GOLD IN CONTACT AREA,
MATTE TIN ON TAIL

OPTION

- P: PICK & PLACE PAD (USE PPP-25)
(USE PPP-25-NT WITH -TR ONLY)
(SEE FIG. 3, SHT 2)(5 POS. MIN)
- TR: TAPE & REEL
.740[18.80] MAX OVERALL HEIGHT AVAILABLE FOR
-TR. MAX OVERALL HEIGHT = POST + BOARDSPACE
+ PAD + ALIGNMENT PIN = .740[18.80]
- ES: END SHROUDS (SEE FIG. 5, SHT 2)
(9 POS PER ROW MIN)
(MAX POST: .075[1.91])
(SEE NOTE 8)
- EP: GUIDE POST (FIG. 6, SHT 3)
(9 POS PER ROW MIN)
(MAX POST: .075[1.91])
(USE ONLY WHEN MATING WITH CLP)
(SEE NOTE 8)
- A: ALIGNMENT PIN (MOLDED OR STAKED, SAMTEC'S
DISCRETION ON WHICH)
(SEE FIG. 7 & 8 SHT 3)
(STAKED: 6 POS. MIN)(MOLDED: 3 POS. MIN)
(SEE NOTE 8)

POST HEIGHT (SEE NOTE 5)

.065[1.65] MIN
POST + BOARD SPACE = "F" =
-03: .150-.400 [3.81-10.16]
*.401-.675 [10.19-17.15]
-05: *.150-.400 [3.81-10.16]
.401-.675 [10.19-17.15]

BOARD SPACE OPTION (SEE NOTE 5)

SEE TABLE 1
-03 LEAD STYLE (.085[2.16] MIN - .335[8.51] MAX)
-05 LEAD STYLE (.248[6.30] MIN - .610[15.49] MAX)
MAX = "A" - POST (SEE TABLE 1)

* = FOR EXISTING CUSTOMERS ONLY

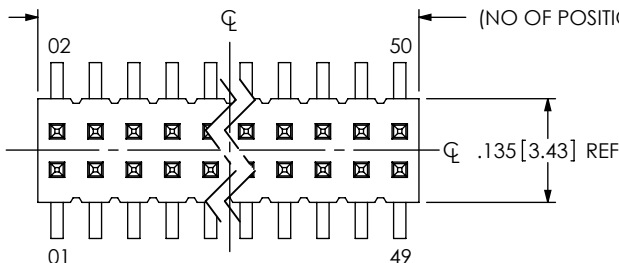

DOUBLE ROW
(SEE TABLE 1 FOR BODY STYLE)

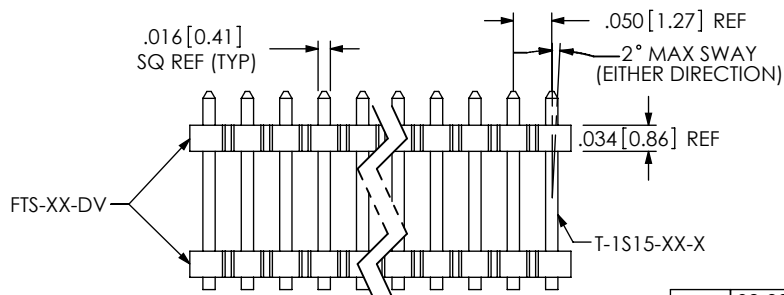

.070[1.78] REF
(CONTACT AREA)

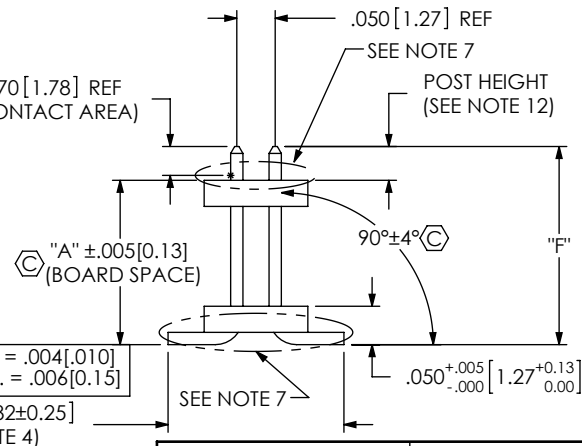

$\text{\textcircled{C}}$.229±.010 [5.82±0.25]
(SEE NOTE 4)

LEAD STYLE	OPTIONS	OVERALL HEIGHT	PACKAGING TUBE	PLUG
-03	-A-P	.150 - .650	PT-FW005-D-03-P	TP-03
-03	NONE, A	.150 - .225	PT-FW005-D-03-P	TP-03
-03	NONE, A	.226 - .309	PT-FW005-D-03-P	TP-03
-03	NONE, A	.310 - .400	PT-FW005-D-03-P	TP-03
-05	NONE, A	.310 - .800	PT-FW006-D-05-P	TP-03
-05	-A-P	.310 - .650	PT-FW006-D-05-P	TP-03
-05	-A-P	.651 - .800	PT-FW006-D-05-P	TP-03
-03, -05	-ES, -EP, -ES-A, -ES-A-P, -ES-P, -EP-A, -EP-P, -EP-A-P	ALL	PT-1-24-01-71	TP-03

PACKAGING NOTE:
TUBE POSITIONS 5-50, LAYER PACKAGE ALL OTHERS

LEAD STYLE	"F" RANGE	TERMINAL PIN
-03	.150-.299	T-1S15-04-X
-03	.300-.400	T-1S15-03-X
-05	.401-.675	T-1S15-03-X

(SEE NOTE 14)

FIG 1

LEAD STYLE	"A" RANGE	"C" RANGE (SEE SHEET 2, FIG 5 & 6)	"D" RANGE (SEE SHEET 2, FIG 5 & 6)	BODY STYLE		FIG
				UPPER BODY	LOWER BODY	
-03	.085 - .214 [2.16 - 5.44]	N/A	N/A	FTS-XX-DV	FTS-XX-DV	1
-03	.215 - .335 [5.46 - 8.51]	.293 - .423 REF [7.45 - 10.75]	.413 - .543 REF [10.50 - 13.79]	FTSH-XX-D	*FTSH-XX-D	2 (SEE SHEET 2)
-05	.248 - .610 [6.30 - 15.49]	.326 - .698 REF [8.28 - 17.73]	.446 - .818 REF [11.32 - 20.78]	FTSH-XX-D	FTSH-XX-D	4 (SEE SHEET 2)

* FOR BKT MACHINE, USE FW-XX-D

UNLESS OTHERWISE SPECIFIED, DIMENSIONS ARE IN INCHES.

TOLERANCES ARE:

DECIMALS ANGLES
.XX: ±.01[0.3]
.XXX: ±.005[0.13]
.XXXX: ±.0020[0.051]

PROPRIETARY NOTE

THIS DOCUMENT CONTAINS CONFIDENTIAL AND PROPRIETARY INFORMATION AND ALL DESIGN, MANUFACTURING, REPRODUCTION, USE, PATENT RIGHTS AND SALES RIGHTS ARE EXPRESSLY RESERVED BY SAMTEC, INC. THIS DOCUMENT SHALL NOT BE DISCLOSED, IN WHOLE OR PART, TO ANY UNAUTHORIZED PERSON OR ENTITY NOR REPRODUCED, TRANSFERRED OR INCORPORATED IN ANY OTHER PROJECT IN ANY MANNER WITHOUT THE EXPRESS WRITTEN CONSENT OF SAMTEC, INC.

MATERIAL: DO NOT SCALE DRAWING SHEET SCALE: 4:1
BODY: LCP, UL 94 VO, COLOR: FTS-50-DV & FTSH-50-D: BLACK
FW-50-D: NATURAL

TERMINAL: PHOS BRONZE

MAX FLASH ALLOWED: .002[0.05]
MAX GATE VESTIGE: .002[0.05]

F:\DWG\MISC\MKTG\FW-XX-XX-XX-D-XXX-XXX-XX-MKT.SLDDRW

DESCRIPTION:
.050 X .050 SURFACE MOUNT BOARD SPACERS

DWG. NO.

FW-XX-XX-XX-D-XXX-XXX-XX

BY: BRATCHER 11-03-1994 SHEET 1 OF 3



520 PARK EAST BLVD, NEW ALBANY, IN 47150
PHONE: 812-944-6733 FAX: 812-948-5047
e-Mail: info@SAMTEC.com code 53322

IN-PROCESS 1

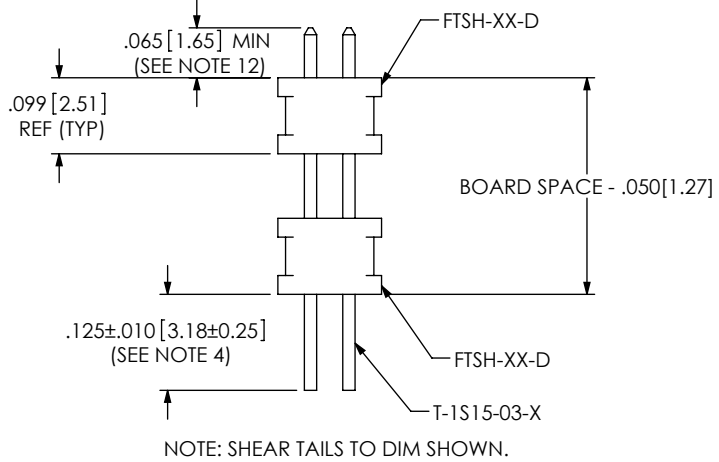

IN-PROCESS 2

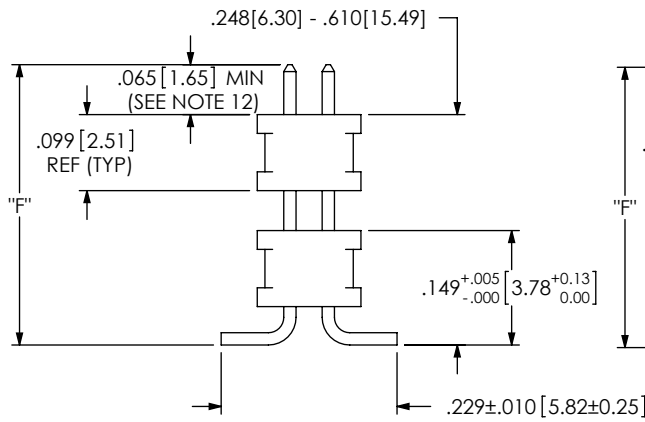

IN-PROCESS 3

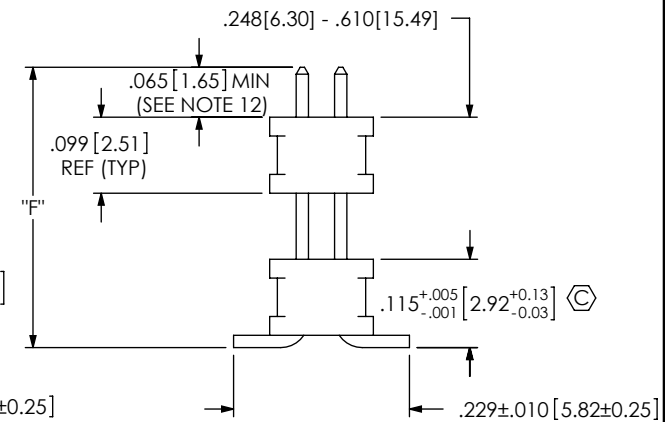

FIG 4

DIFFERENT AS SHOWN, OTHERWISE THE SAME AS FIG 1

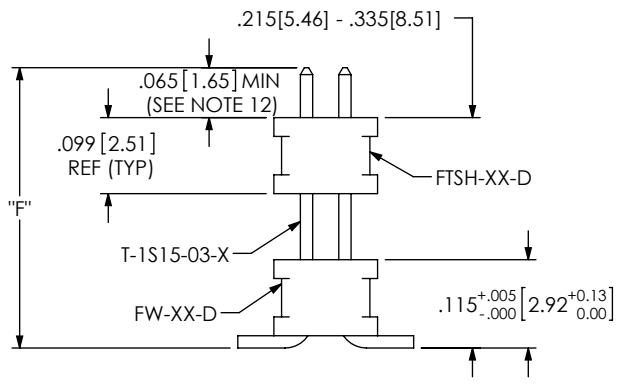

FIG 2

(BKT MACHINE)

DIFFERENT AS SHOWN, OTHERWISE THE SAME AS FIG 1

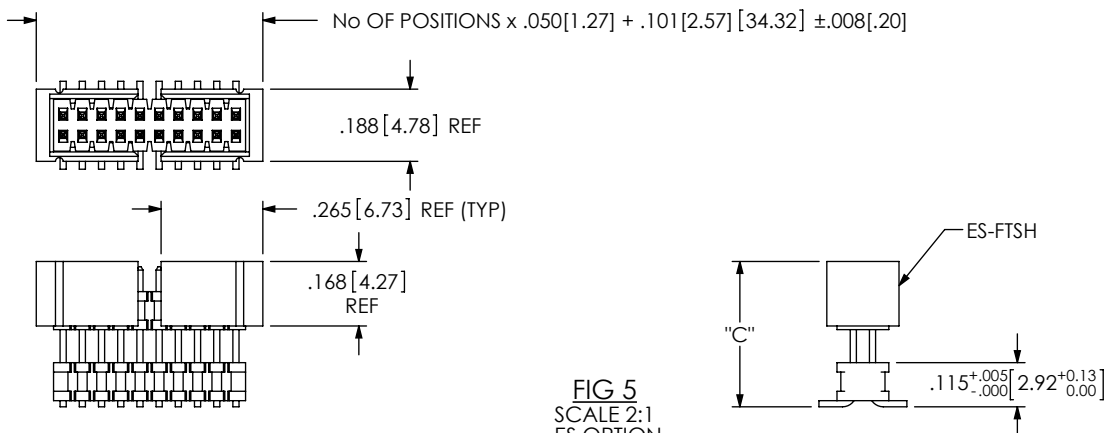

FIG 5

SCALE 2:1

-ES OPTION

DIFFERENT AS SHOWN, OTHERWISE THE SAME AS FIG 1

9 POSITION MINIMUM (SEE NOTE 8)

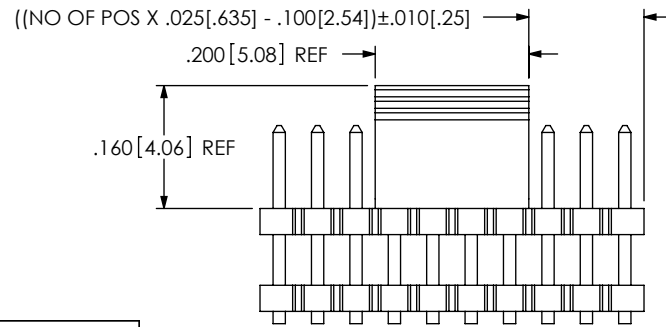
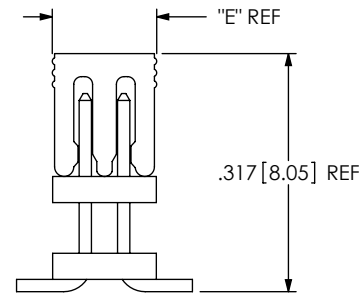

FIG 3

(PICK AND PLACE PAD)
(5 POSITION MINIMUM)



SHOWN WITH LEAD STYLE -03

TABLE 3	
PART No.	"E"
PPP-25	.130 [3.30]
PPP-25-NT	.230 [5.84]

PROPRIETARY NOTE
THIS DOCUMENT CONTAINS CONFIDENTIAL AND PROPRIETARY INFORMATION AND ALL DESIGN, MANUFACTURING, REPRODUCTION, USE, PATENT RIGHTS AND SALES RIGHTS ARE EXPRESSLY RESERVED BY SAMTEC, INC. THIS DOCUMENT SHALL NOT BE DISCLOSED, IN WHOLE OR PART, TO ANY UNAUTHORIZED PERSON OR ENTITY NOR REPRODUCED, TRANSFERRED OR INCORPORATED IN ANY OTHER PROJECT IN ANY MANNER WITHOUT THE EXPRESS WRITTEN CONSENT OF SAMTEC, INC.

DO NOT SCALE DRAWING
SHEET SCALE: 4:1



520 PARK EAST BLVD, NEW ALBANY, IN 47150
PHONE: 812-944-6733 FAX: 812-948-5047
e-Mail info@SAMTEC.com code 55322

DESCRIPTION:
.050 x .050 SURFACE MOUNT BOARD SPACERS

DWG. NO.
FW-XX-XX-XX-D-XXX-XXX-XX

BY: BRATCHER 11-03-1994 SHEET 2 OF 3

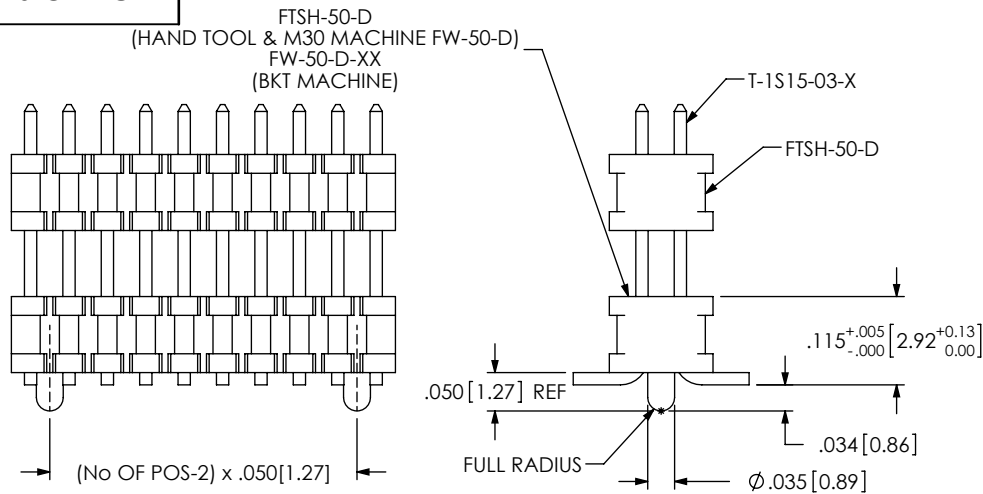

FIG 7
-A OPTION (MOLDED)
MOLD 3 POSITION MIN
DIFFERENT AS SHOWN OTHERWISE SAME AS FIG 1

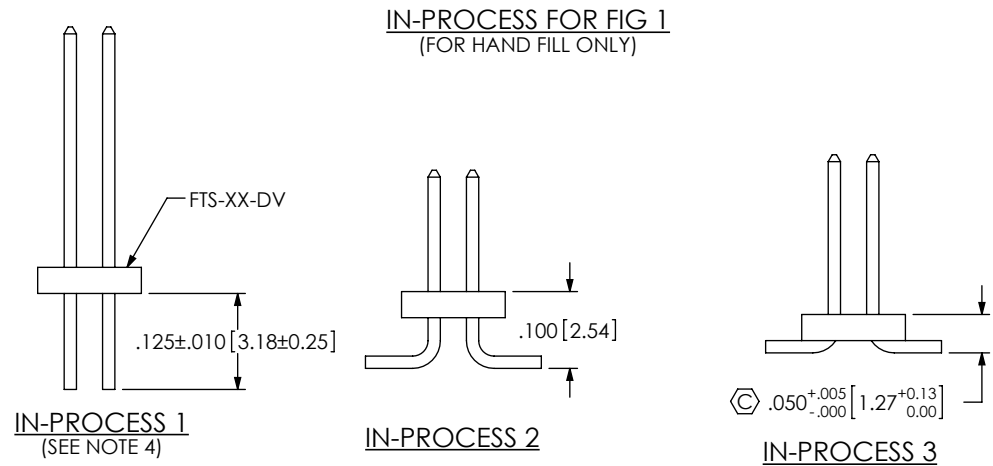

FIG 6
-EP OPTION
USE ONLY WHEN MATING TO CLP
(9 POSITION MIN)
(SEE NOTE 8)
DIFFERENT AS SHOWN, OTHERWISE SAME AS FIG 1

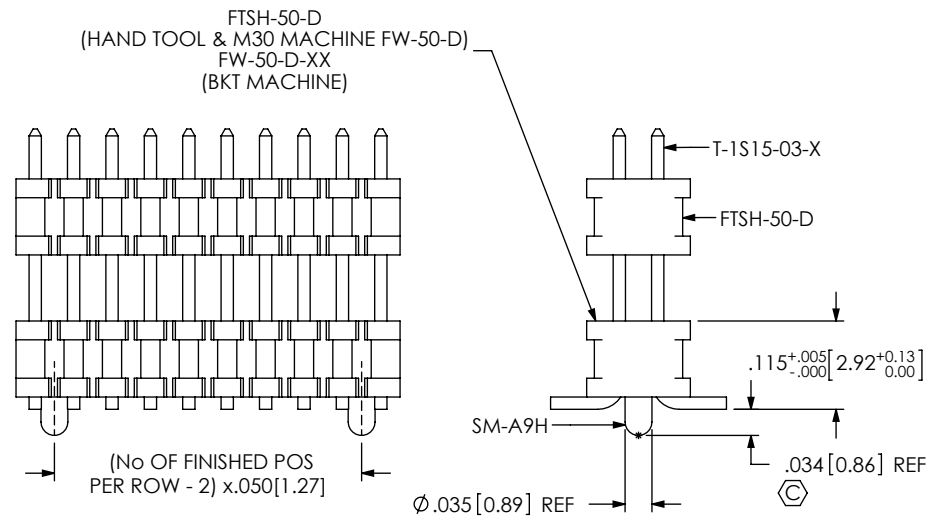
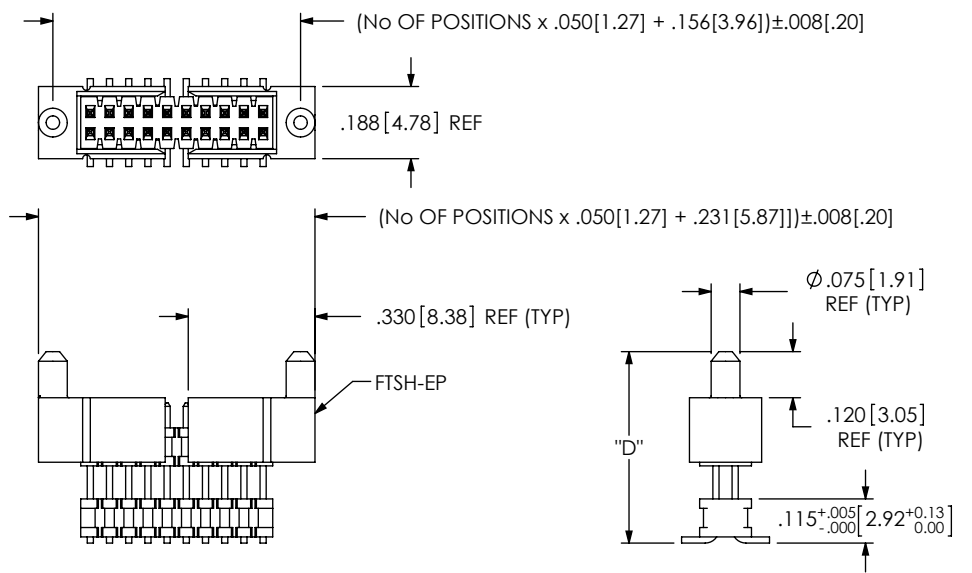

FIG 8
-A OPTION (STAKED)
6 POSITION MIN
DIFFERENT AS SHOWN OTHERWISE SAME AS FIG 1



PROPRIETARY NOTE
THIS DOCUMENT CONTAINS CONFIDENTIAL AND PROPRIETARY INFORMATION AND ALL DESIGN, MANUFACTURING, REPRODUCTION, USE, PATENT RIGHTS AND SALES RIGHTS ARE EXPRESSLY RESERVED BY SAMTEC, INC. THIS DOCUMENT SHALL NOT BE DISCLOSED, IN WHOLE OR PART, TO ANY UNAUTHORIZED PERSON OR ENTITY NOR REPRODUCED, TRANSFERRED OR INCORPORATED IN ANY OTHER PROJECT IN ANY MANNER WITHOUT THE EXPRESS WRITTEN CONSENT OF SAMTEC, INC.



520 PARK EAST BLVD, NEW ALBANY, IN 47150
PHONE: 812-944-6733 FAX: 812-948-5047
e-Mail info@SAMTEC.com code 55322

DO NOT SCALE DRAWING
SHEET SCALE: 4:1

DESCRIPTION:
.050 x .050 SURFACE MOUNT BOARD SPACERS

DWG. NO.
FW-XX-XX-XX-D-XXX-XXX-XX

BY: BRATCHER 11-03-1994 SHEET 3 OF 3