



Chipsmall Limited consists of a professional team with an average of over 10 year of expertise in the distribution of electronic components. Based in Hongkong, we have already established firm and mutual-benefit business relationships with customers from,Europe,America and south Asia,supplying obsolete and hard-to-find components to meet their specific needs.

With the principle of “Quality Parts,Customers Priority,Honest Operation,and Considerate Service”,our business mainly focus on the distribution of electronic components. Line cards we deal with include Microchip,ALPS,ROHM,Xilinx,Pulse,ON,Everlight and Freescale. Main products comprise IC,Modules,Potentiometer,IC Socket,Relay,Connector.Our parts cover such applications as commercial,industrial, and automotives areas.

We are looking forward to setting up business relationship with you and hope to provide you with the best service and solution. Let us make a better world for our industry!



Contact us

Tel: +86-755-8981 8866 Fax: +86-755-8427 6832

Email & Skype: info@chipsmall.com Web: www.chipsmall.com

Address: A1208, Overseas Decoration Building, #122 Zhenhua RD., Futian, Shenzhen, China



Reliable protection for semiconductor devices and sensitive electronic equipment



Bussmann® series high speed fuses

High speed fuses protect sensitive devices and power semiconductors from short-circuits, and are specifically designed to minimize the I^2t , peak let-through current and arc voltage.

Typical applications:

- Protection of AC and DC drives
- DC common bus
- Power converters/rectifiers
- Reduced voltage starters
- UPS
- Capacitor protection
- Switchboard panels
- Control consoles



Our extensive line of high speed fuses offer these styles:



North American
(round body)

IGBT fuses

Ferrule fuses



British Standard BS 88

Square body fuses

Bussmann series high speed fuses also include

Compact high speed fuses that require less space



Our new Bussmann series compact high speed fuses protect compact drives, power conversion and UPS equipment. These 50-400 amp fuses require up to 48% less enclosure space when compared with traditional high speed, round body fuses without compromising heat rise performance.

UL® Listed Class J high speed fuses for full range protection

Bussmann series full range DFJ high speed, current-limiting fuses provide overload and short-circuit protection for variable speed drives and electric controllers, and meet NEC® branch circuit protection requirements. The DFJ drive fuse has the lowest I^2t of any UL branch circuit fuse in the industry to protect power semiconductor devices that utilize diodes, GTOs, SCRs and SSRs.





Custom order engineering to meet unique application needs

No matter the space constraints, mounting requirements or rating concerns, our Custom Order Engineering team can quickly modify existing products to meet your application needs. This includes adding microswitch capability for remote indication to ease maintenance and reduce downtime.

QuikShip Made-to-Order Service for faster shipment

21-day or less lead-time is available with QuikShip Made-to-Order service on over 400 of the most popular Bussmann series square body high speed fuses up to 1000 V and 2000 A.



Application engineering support

Technical assistance on questions about your application is available at fusetech@eaton.com or call toll-free 855-BUSSMANN (855-287-7626) during regular business hours.



Field application engineering

Available throughout North America, field application engineers are available to assist with your design and application efforts.



Table of contents

Section	Volts	Amp range	Catalog symbol/size	Page	
High speed fuses — general applications				6-7	
Compact high speed fuses				8-9	
Fuses	500 Vac/dc	50 to 400 A	CHSF	8-9	
UL Class J full range drive fuse				10-11	
Fuses	600 Vac/450 Vdc	1 to 600 A	DFJ	10-11	
North American fuses				12-22	
General information				12	
Fuses	130 Vac/dc	1000 to 4000 A	FWA	13	
	150 Vac/dc	70 to 1000 A	FWA	14	
	250 Vac/dc	35 to 2500 A	FWX	15	
	500 Vac/dc	35 to 1600 A	FWH	16	
	600 Vac	1 to 1000 A	KAC	17	
	600 Vac	35 to 800 A	KBC	18	
	700 Vac/dc	5 to 1200 A	FWP	19-20	
	1000 Vac/800 Vdc	35 to 2000 A	FWJ	21	
Accessories	Modular fuse blocks			22	
British Standard BS88 fuses				23-30	
General information				23	
Fuses	240-250-280 Vac/150 Vdc	6 to 180 A	LCT, LET	24	
	240-250 Vac/150 Vdc	160 to 900 A	LMT, LMMT	25	
	690-700 Vac/500 Vdc	6 to 200 A	CT, ET, FE, EET and FEE	26-27	
	690-700 Vac/350-450-500 Vdc	160 to 710 A	FM, FMM, MT and MMT	29-29	
Accessories	Trip indicators, clips and microswitches			30	
Ferrule fuses				31-46	
General information				31	
Fuses	150 Vac/dc	5 to 30 A	FWA-_A10F (10x38 mm)	32	
	150 Vac/dc	35 to 60 A	FWA-_A21F (21x51 mm)	32	
	250 Vac/dc	1 to 50 A	FWX (14x51 mm)	33	
	500 Vac	0.25 to 30 A	FWH-_A6F (6x32 mm)	34	
	500 Vac/dc	1 to 30 A	FWH-_14F (14x51 mm)	35	
	600-700 Vac/700 Vdc	1 to 32 A	FWC (10x38mm)	36	
	690-700 Vac/600-700 Vdc	1 to 50 A	FWP-_A14F (14x51 mm)	37	
	700 Vac/dc	20 to 100 A	FWP-_A22F (22x58 mm)	38	
	750 Vdc	5 to 30 A	FWK-_A20F (20x127 mm)	39	
	750 Vdc	35-60 A	FWK-_A25F (25x146 mm)	39	
	1000 Vac/800 Vdc	20 to 30 A	FWJ (14x67 mm)	40	
	1200 Vac/1000 Vdc	20 to 30 A	FWL (20x127 mm)	41	
	1400-2000 Vac/1000 Vdc	2 to 15 A	FWS (20x127 mm)	42	
	Accessories	JM70100 700 V DIN-Rail/panel mount modular blocks for FWP 22x58 mm fuses			43
		CHM modular holders for FWA and FWC 10x38 mm fuses			44
	CH14 modular holders for FWX, FWH and FWP 14x51 mm fuses			45	
	CH22 modular holders for FWP 22x58 mm fuses			46	
Square body fuses				47-92	
General information				47	
DIN 43653	690-700 Vac/ 700 Vdc	10 to 400 A	170M — size 000 and 00	48-49	
	690-700 Vac	40 to 2000 A	170M — size 1* to 3	50-51	
	1000 Vac	20 to 315 A	170M — size 00	52	
	1000 Vac	50 to 1400 A	170M — size 1* to 3	53-54	
	1250-1300 Vac	50 to 1400 A	170M — size 1* to 3	55-56	
DIN 43620	690 Vac	10 to 800 A	170M — size 00 to 3	57-58	
	690-700 Vac	10 to 1600 A	170M — size 000 to 3 dual indicator	59-60	
	1000 Vac	20 to 225 A	170M — size 00	61	
French style	690-700 Vac	40 to 1600 A	170M — size 1* to 3	62-63	

Table of contents

Section	Volts	Amp range	Catalog symbol/size	Page
Square body fuses — continued				
US style	690-700 Vac	40 to 2000 A	170M — size 1* to 3	64-65
	1000 Vac	50 to 1400 A	170M — size 1* to 3	66-67
	1250-1300 Vac	50 to 1400 A	170M — size 1* to 3	68-69
Flush-end contact	690 Vac	25 to 400 A	170M — size 00	70
	690-700 Vac	40 to 2000 A	170M — size 1* to 3	71-72
	1000 Vac	50 to 1400 A	170M — size 1* to 3	73-74
	1250-1300 Vac	50 to 1400 A	170M — size 1* to 3	75-76
	690-700 Vac	1000 to 4000 A	170M — size 4	77-78
	1000 Vac	1000 to 3000 A	170M — size 4	79-80
	1250 Vac	800 to 2500 A	170M — size 4	81-82
	660 Vac	1000 to 4000 A	170M — size 23	83-84
	1250 Vac	630 to 2800 A	170M — size 23	85
	690 Vac	2000 to 7500 A	170M — size 24	86
	1000 Vac	2000 to 5000 A	170M — size 24	87
	1100-2000 Vac	1800 to 5500 A	170M — size 5	88
	Accessories	Fixed center blocks for DIN 43653 fuses		
Indicators			91	
Microswitches			91-92	
IGBT fuses				93-97
General information				93
Fuses	750-800 Vdc	25 to 630 A	170M — size 000 and 230	94-95
	1000 Vdc	25 to 500 A	170M — size 000 and 230	96-97
Index				98-99

New high speed fuse application guide

This 36-page application guide helps users understand the dynamics involved in the high speed fuse specification and selection process.

It covers high speed fuse characteristics, performance data, application in AC and DC systems along with worked examples that explore the influence of overloads and cyclic loadings, and safety margins.

Other topics include international standards, Bussmann series high speed fuse reference systems along with installation, service, maintenance tips.

Available online or as a printed document, look for publication no. 10507.



High speed fuses — general applications

Rated voltage

The AC voltage rating of Eaton's Bussmann series fuses is given in volts RMS. Fuses tested to IEC are tested at 5% above their rated voltage. British Style BS 88 fuses are tested at 10% above its rated voltage. UL recognition tests are performed at the rated voltage.

Rated current

Rated current is given in amps RMS. Bussmann series fuses can continuously carry the rated current.

Melting characteristic

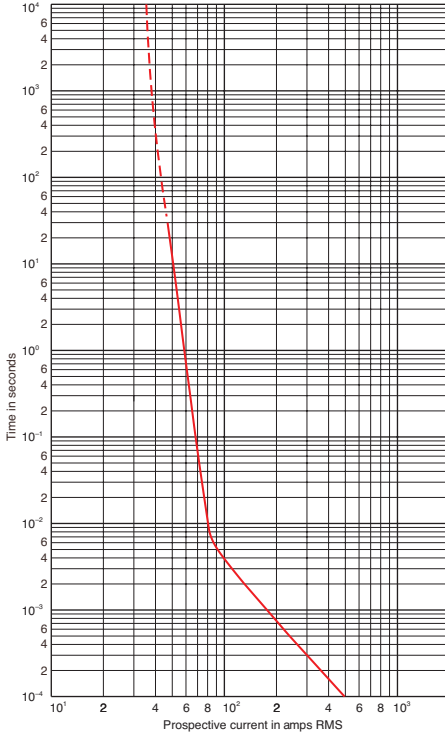

The melting characteristic shows the virtual melting time in seconds as a function of the prospective current in amps RMS. The fuses are specially constructed for short-circuit protection against high level fault currents. Loading and operation of the fuse in the noncontinuous/dashed section of the melt curve must be avoided. The curve can also be read as the real melting time as a function of the RMS value of the pre-arc current.

Clearing integrals

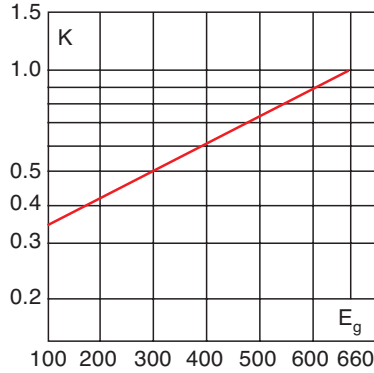

The total clearing I^2t at rated voltage and at power factor of 15% are given in the electrical characteristics. For other voltages, the clearing I^2t is found by multiplying by correction factor, K, given as a function of applied working voltage, E_g , (RMS).

Power factor

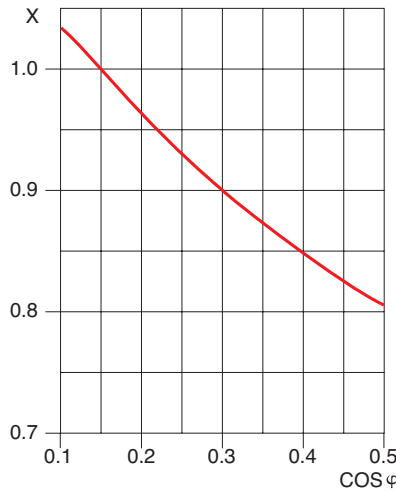

For other power factor values, the total clearing integral can be calculated as a multiple of the clearing integrals, the correction factor K and the correction factor X.

Arc voltage

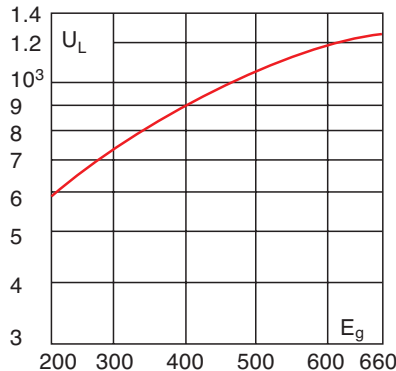

This curve gives the peak arc voltage, U_L , which may appear across the fuse during its operation as a function of the applied working voltage, E_g , (RMS) at a power factor of 15%.

Power losses

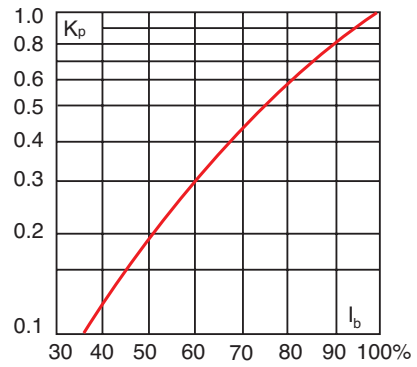

Watts loss at rated current is given in the electrical characteristics. The curve allows the calculation of the power losses at load currents lower than the rated current. The correction factor, K_p , is given as a function of the RMS load current, I_b , in % of the rated current.

Cut-off current

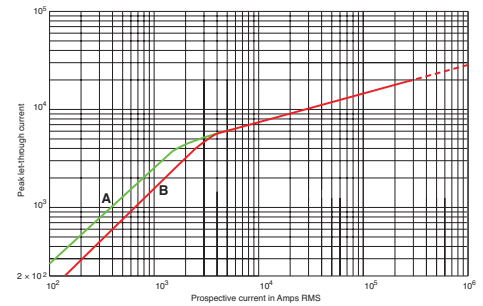

A fuse operation relating to short-circuits only. When a fuse operates in its current-limiting range, it will clear a short-circuit in less than 1/2 cycle. Also, it will limit the instantaneous peak let-through current to a value substantially less than that obtainable in the same circuit if that fuse were replaced with a solid conductor of equal impedance.

A (asymmetrical current)

B (symmetrical current)

Parallel connection

When fuses are connected in parallel, it is recommended that the applied voltage does not exceed $0.9 U_N$ (the rated voltage of the fuse). This is due to the fact that the energy released within the fuses may be unevenly shared between the parallel connected barrels.

When fuses are connected in parallel, one must take into account that the current sharing is not necessarily equal. And it must be checked, that the maximum load current is not exceeded.

High speed fuses — general applications

Series connection

Fuses in series may not equally divide the applied voltage. It is recommended that series connected fuses should only be operated at fault currents that yield melting times less than 10 ms and a recovery voltage per fuse of less than or equal to $0.9 U_N$ (the rated voltage of the fuse).

Mounting guidance

The recommendations below have to be followed when mounting a Bussmann series fuse with end plate threaded holes.

1. Screw in studs: 5 N•m Max, 3 N•m Min
2. Attachment to a bussbar with a nut and washer:

Thread	Torque (N•m)* max/min
5/16–18, M8	25/20
3/8–16, M10	45/40
3/8–24	45/40
1/2–13, M12	65/50
1/2–20	65/50
*1 N•m = 0.7375 lb-ft	

Overloads

The design of Bussmann series fuses is such that they can be operated under rather severe operating conditions imposed by overloads (any load current in excess of the maximum permissible load current).

In applications, there will be a maximum overload current, I_{max} , which can be imposed on the fuse with a corresponding duration and frequency of occurrence.

Time durations fall into two categories:

1. Overloads longer than one second
2. Overloads less than one second termed “impulse” loads

The following table gives general application guidelines which, in the expression $I_{max} < (\% \text{ factor}) \times I_t$, I_t is the melting current corresponding to the time “t” of the overload duration as read from the time-current curve of the fuse. The guidelines in the table below determine the acceptability of the selected fuses for a given I_{max} .

Frequency of occurrence	Overloads (> 1 sec)	Impulse loads (< 1 sec)
Less than once per month	$I_{max} < 80\% \times I_t$	$I_{max} < 70\% \times I_t$
Less than twice per week	$I_{max} < 70\% \times I_t$	$I_{max} < 60\% \times I_t$
Several times per day	$I_{max} < 60\% \times I_t$	—

When impulse loads are an intrinsic/normal parameter of the load current either as single pulse or in trains of pulses or when their level is higher than the melting current at 0.01 seconds (per time-current curve), contact our application engineers for assistance.

In addition to the parameters set forth in the preceding table, the RMS value of the load current as calculated for any period of 10 minutes or more should not exceed the maximum permissible load current.

Furthermore, it is important that a fuse should not be applied in the non-continuous/dashed portion of the associated time-current curve.

Any time-current combination point which falls in the non-continuous/dashed portion of the time-current curve is beyond the capability of the fuse to operate properly.

DC operation

Depending upon the short-circuit time constant and the magnitude of the prospective short-circuit current, the DC voltage at which a fuse can be applied may be less than its AC rating. Long time constants require a lower DC voltage. Conversely, however, higher available prospective short-circuit currents result in faster fuse openings and thus permit a fuse to be operated at a higher DC voltage.

Consult Eaton for additional information and application assistance when fuses have to operate under DC conditions.

Load current versus conductor cross section

Reduction of permissible load current when the conductor cross section is less than that given in IEC Publication 269-1 and 4 valid for Bussmann series high speed fuses.

Application assistance

If you have application problems, please consult our application engineers. Email fusetech@eaton.com or call toll-free 855-BUSSMANN (855-287-7626) Monday through Friday, 7:00 a.m. to 5:00 p.m. Central Time.

Custom Order Engineering

If your application needs a fuse outside our standard product offering, please contact your Bussmann series product representative to see if we can supply you with a custom order engineered product.

Compact high speed fuses

CHSF — UL high speed fuse

500 Vac/dc (UL), 50 to 400 A

Description

Eaton's Bussmann® series compact high speed fuses feature space-saving case sizes for protecting semiconductor devices up to 500 Vac/dc in ratings from 50 to 400 amps.

Specifications

Ratings

- Volts:
 - 500 Vac/dc (UL)
- Amps: 50-400 A
- Interrupting rating
 - Max AC – 200 kA
 - Min AC 400%
 - Max DC – 50 kA
 - Min DC 800%

Operating class: aR

Agency information

- UL® Recognized, File E56412, Guide JFHR2
- CSA® Component Acceptance, Class 1422-30, File 53787
- IEC® aR (self certified)
- CE
- RoHS compliant
- REACH declaration available upon request

Features:

- Use up to 48% less enclosure space to help reduce the overall assembly size
- Innovative design allows for a significantly smaller package without compromising heat rise performance, preventing extensive equipment redesign
- Global acceptance with UL, CSA, IEC and RoHS for products sold worldwide
- Bolt-on design provides design flexibility for installation in fuse blocks or direct mounting on busbars
- Meets JASO D622 spec for thermal shock, humidity, and vibration
- Superior current cycling performance helps withstand demanding applications



Recommended fuse blocks

Up to 100 amps

Catalog no.	Wire size	Stud size
BH-0111	#14-2/0 Cu	1/4-20
BH-0112	#14-2/0 Cu	5/16-18
BH-0121	(2) #14-1/0 Cu	1/4-20
BH-0122	(2) #14-1/0 Cu	5/16-18
1BS101	#14-2/0 Cu	1/4-20 x 1/2

See data sheet No. 1200 (BH-01_) and No. 1206 (1BS101) for details.

Up to 400 amps

Catalog no.	Wire size	Stud size
BH-1131	#6-250 kcmil Cu	1/4-20
BH-1132	#6-250 kcmil Cu	5/16-18
1BS102	#6-250 kcmil Cu	1/4-20 x 1/2

See data sheet No. 1201 (BH-11_) and No. 1207 (1BS102) for details.

Compact high speed fuses

Catalog numbers:

Catalog number	Amps	AC/DC I ² t (A ² s) pre-arcing	AC* I ² t (A ² s) total clear	DC** I ² t (A ² s) total clear	Watts loss / percent of rated current	
					@ 80%	@ 50%
CHSF-50	50	304	1875	935	3.8	1.3
CHSF-60	60	438	2700	1346	4.5	1.5
CHSF-70	70	596	3675	1833	5.3	1.8
CHSF-80	80	778	4800	2394	6.1	2.0
CHSF-100	100	1216	7500	3740	7.6	2.5
CHSF-125	125	2042	12,721	6465	12.0	3.6
CHSF-150	150	2941	18,318	9309	14.3	4.3
CHSF-175	175	4003	24,933	12,671	16.7	5.1
CHSF-200	200	5228	32,566	16,550	19.1	5.8
CHSF-225	225	6835	48,028	21,278	26.1	7.0
CHSF-250	250	8438	59,293	26,270	29.0	7.8
CHSF-300	300	12,151	85,382	37,828	34.8	9.4
CHSF-350	350	16,539	116,215	51,488	40.6	10.9
CHSF-400	400	21,603	151,791	67,250	46.4	12.5

* @ 200 kA/500 Vac.

** @ 50 kA/500 Vdc.

Dimensions — mm:

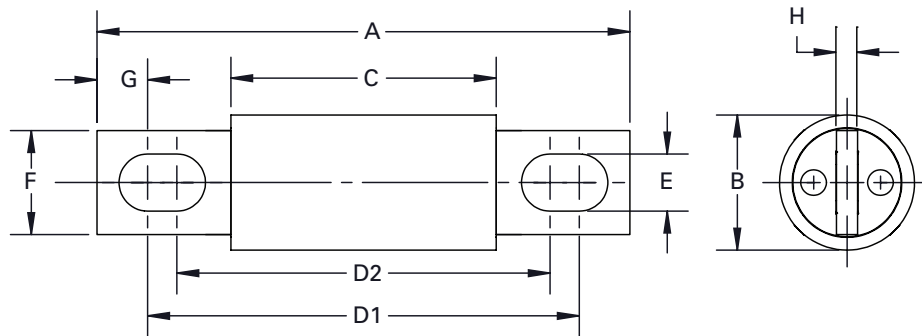

Case size amp range	A	B	C	D1	D2	E	F	G	H
50-100	81	20	40	61	57	8.7	16	7.7	3.2
125-200	92	25	53	77	68	8.7	19	7.8	3.2
225-400	92	30	53	74	68	8.7	25	9.0	4.8

UL Class J full range high speed drive fuses

DFJ — UL Class J full range high speed fuse

600 Vac/450 Vdc (UL), 1 to 600 A

Description

UL Class J high speed, full range current-limiting fuses provide maximum protection for AC and DC drives and controllers. The UL Class J Bussmann series DFJ fuse has the lowest I^2t of any branch circuit fuse to protect power semiconductor devices that utilize diodes, GTOs, SCRs and SSRs. The DFJ fuse combines the performance of high speed fuses in a full range Class J branch circuit package, allowing the use of readily available Class J fuse blocks, holders and switches.

Specifications

Ratings

- Volts:
 - 600 Vac (UL)
 - 450 Vdc (UL) (15-600 A)
- Amps: 1-600 A
- Interrupting rating:
 - 200 kA RMS Sym.
 - 100 kA DC

Operating class: aR

Agency information

- UL Listed, Std 248-8, Class J, Guide JDDZ, File E4273
- CSA Certified, C22-2 No 248.8, Class 1422-02, File 53787

Dimensions — in

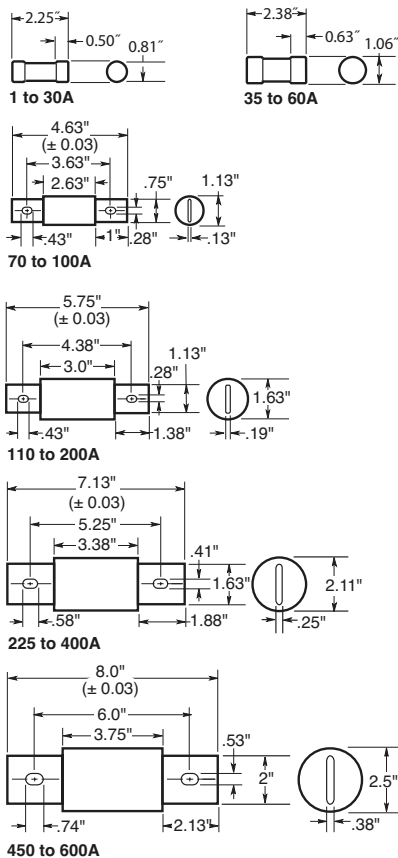

Catalog no.	I^2t (A ² Sec) @ 600 Vac/100 kA			Watts loss*
	Amps	Pre-arc	Clearing	
DFJ-1	1	—	—	—
DFJ-2	2	—	—	—
DFJ-3	3	—	—	—
DFJ-4	4	—	—	—
DFJ-5	5	—	—	—
DFJ-6	6	—	—	—
DFJ-8	8	—	—	—
DFJ-10	10	—	—	—
DFJ-12	12	—	—	—
DFJ-15	15	4	110	4.1
DFJ-17.5	17.5	—	—	—
DFJ-20	20	8	365	4.0
DFJ-25	25	12	610	4.9
DFJ-30	30	20	1000	5.5
DFJ-35	35	55	1100	6.8
DFJ-40	40	90	1900	8.6
DFJ-50	50	140	2800	8.7
DFJ-60	60	290	6000	8.5
DFJ-70	70	450	3100	12
DFJ-80	80	650	4600	13
DFJ-90	90	1010	7200	13
DFJ-100	100	1460	10,500	13
DFJ-110	110	1710	9500	17
DFJ-125	125	3580	20,000	15
DFJ-150	150	5080	28,000	19
DFJ-175	175	6310	35,000	23
DFJ-200	200	9850	54,500	24
DFJ-225	225	11,420	51,000	29
DFJ-250	250	17,000	74,500	30
DFJ-300	300	23,500	103,000	36
DFJ-350	350	38,800	170,000	39
DFJ-400	400	62,200	272,000	40
DFJ-450	450	44,600	270,000	56
DFJ-500	500	79,500	480,000	52
DFJ-600	600	138,000	830,000	57

* Watts loss at rated current.

UL Class J full range high speed drive fuses

Recommended fuse blocks

30 and 60 amp block catalog numbers

Fuse amp range	Poles	Terminal type				Optional covers*	
		Box lug/slot screw	Box lug/hex screw	#10-32 Phil-slot screw	Pressure plate	Indicating**	Non-indicating
up to 30	1	JM60030-1CR	JM60030-1CHR	JM60030-1SR	JM60030-1PR	CVRI-J-60030	CVR-J-60030
	2	JM60030-2CR	JM60030-2CHR	JM60030-2SR	JM60030-2PR		
	3	JM60030-3CR	JM60030-3CHR	JM60030-3SR	JM60030-3PR		
35 to 60	1	JM60060-1CR	JM60060-1CHR	—	—	CVRI-J-60060	CVR-J-60060
	2	JM60060-2CR	JM60060-2CHR	—	—		
	3	JM60060-3CR	JM60060-3CHR	—	—		

* Covers sold separately, one cover per pole.

** Open fuse indication requires 90 volts minimum and closed circuit to operate.

30 and 60 amp block terminals and conductors

Terminal type	AWG type/range	AWG	Torque N·m (lb-in)
Box lug	75°C Cu 2-14, Al 2-8	2-3	5.6 (50)
		4-6	5.1 (45)
		8	4.5 (40)
		10-14	4.0 (35)
#10-32 Phil-slot screw	75/90°C Cu 10-18	10-18	2.3 (20)
Pressure plate			

Data sheet: 10488

100 to 600 amp knifeblade blocks and covers

Fuse amp range	Poles	Covers*		Conductors***		Torque N·m (lb-in)	
		Catalog no.	Indicating**	Non-indicating	Solid and stranded		Fine stranded
70-100	1	JM60100-1CR	CVR-J-60100	CVRI-J-60100	—	Cu 1-3 AWG	6.2 (55)
	2	JM60100-2CR			1/0-3 AWG; (2) Cu 4-6 AWG	Cu 4-6 AWG	5.6 (50)
					2 4-6 AWG; (2) Cu 8 AWG	Cu 8 AWG	5.1 (45)
3	JM60100-3CR	8 AWG; (2) Cu 10-14 AWG	—	4.5 (40)			
110-200	1	JM60200-1CR	CVR-J-60200	CVRI-J-60200	Cu 10-14 AWG; Al 10-12 AWG	—	4.0 (35)
	2	JM60200-2CR			250 kcmil-1 AWG	Cu 3/0-1 AWG	42 (375)
	3	JM60200-3CR			2-6 AWG; (2) Cu 2-6 AWG	Cu 2-6 AWG	31 (275)
225-400	1	JM60400-1CR	CVR-J-60400	CVRI-J-60400	600 kcmil	N/A	57 (500)
	2	JM60400-2CR			500 kcmil-4 AWG		51 (450)
	3	JM60400-3CR			(2) Cu 3/0 - 4 AWG		34 (300)
	1	JM60400-1MW22					
	2	JM60400-2MW22					
	3	JM60400-3MW22			(2) Al 3/0 - 4 AWG		
450-600	1	JM60600-1CR	CVR-J-60600	CVRI-RH-60600	2 (2) 500 kcmil-4 AWG	N/A	51 (450)
	2	JM60600-2CR					
	3	JM60600-3CR					

* Covers sold separately.

** Open fuse indication requires 90 volts minimum and closed circuit to operate.

*** Ratings for copper and aluminum conductors except where otherwise noted.

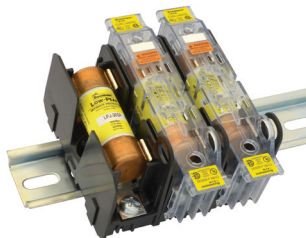

DIN-Rail or panel mount 30 and 60 A modular blocks dovetail together and are available with optional IP20 finger-safe covers.



Panel mount 100 to 600 amp modular knifeblade blocks dovetail together and are available with optional IP20 finger-safe covers.

Data sheet: 1048

North American fuses



General information

Eaton offers a complete range of Bussmann series North American blade and flush-end style fuses and accessories. Their design and construction are optimized to provide:

- Low energy let-through (I^2t)
- Low watts loss
- Superior cycling capability
- Low arc voltage
- Excellent DC performance

North American style fuses provide an excellent solution for medium power applications. While there are currently no published standards for these fuses, the industry has standardized on mounting centers that accept Bussmann series fuses.

Features and benefits

- Excellent DC performance
- Low arc voltage and low energy let-through (I^2t)
- Low watts loss
- Superior cycling capability

Typical applications

- DC common bus
- DC drives
- Power converters/rectifiers
- Reduced voltage starters

Voltage rating

All Bussmann series North American style fuses are tested at their rated voltage. Eaton should be consulted for applications exceeding those values.

Accessories

External and internal open fuse indication is available for selected portions of the North American line. Fuse blocks are available for most applications.

North American contents

Fuses

Catalog symbol	Volts	Amp range	Page
FWA	130	1000-4000	13
FWA	150	70-1000	14
FWX	250	35-2500	15
FWH	500	35-1600	16
KAC	600	1-1000	17
KBC	600	35-800	18
FWP	700	5-1200	19-20
FWJ	1000	35-2000	21

Accessories

Modular style fuse blocks	Amp range	Page
Stud type	100-200	22
Connector type	100-700	22

FWA

130 Vac/dc (UL), 1000 to 4000 A

Description

North American style flush-end high speed fuses for the protection of DC common bus, DC drives, power converters/rectifiers and reduced rated voltage starters.

Specifications

Ratings

- Volts: 130 Vac/dc (UL)
- Amps: 1000-4000 A
- Interrupting rating:
 - 200 kA RMS Sym at 130 Vac
 - 50 kA at 130 Vdc

Agency information

- UL Recognized JFHR2, E91958 on 1000-2000 A fuses
- CE



Rated voltage	Rated current (amps)	I^2t (A ² s)		Watts loss (W)*	Catalog no.
		Pre-arcing	Clearing at 130 Vac		
130 Vac/dc (UL)	1000	170,000	460,000	60	FWA-1000AH
	1200	270,000	730,000	70	FWA-1200AH
	1500	520,000	1,400,000	78	FWA-1500AH
	2000	860,000	2,400,000	108	FWA-2000AH
	2500	1,500,000	4,100,000	130	FWA-2500AH
	3000	2,100,000	5,700,000	150	FWA-3000AH
	4000	3,400,000	9,200,000	257	FWA-4000AH

* Watts loss at rated current.

Dimensions — in

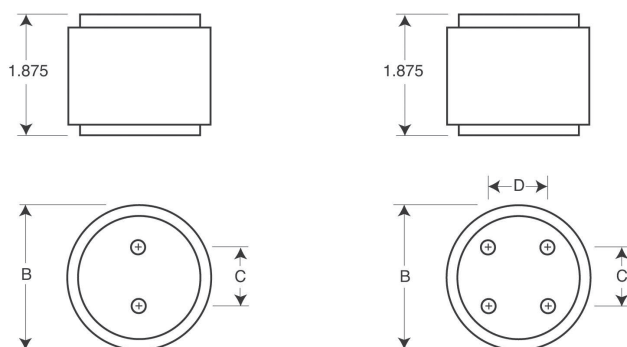

1000-3000 A

4000 A

Amps	B	C	D	Thread depth
1000 to 2000	2.0	1.0	—	3/8-24 x 1/2" UNF
2500 to 3000	3.0	1.5	—	1/2-20 x 1/2" UNF
4000	3.5	1.5	1.5	1/2-20 x 1/2" UNF

1" = 25.4 mm

For details on electrical characteristics, contact Application Engineering and ask for data sheets: 720001, 5785301

North American fuses

FWA

150 Vac/dc (UL), 70 to 1000 A

Description

North American style bolted tag high speed fuses used for the protection of DC common bus, DC drives, power converters / rectifiers and reduced rated voltage starters.

Specifications

Ratings

- Volts:
 - 150 Vac/dc (UL)
 - 80 Vdc 1000 A only
- Amps: 70-1000 A
- Interrupting rating:
 - 100 kA RMS Sym. (70-400 A)
 - 200 kA RMS Sym. (450-1000 A)
 - 20 kA at 150 Vac/ Vdc (70-800 A)
 - 100 kA at 80 Vdc (70-1000 A)



Agency information

- UL Recognized JFHR2, E91958
- CE

Rated voltage	Rated current (amps)	I ² t (A ² s)		Watts loss (W)*	Catalog no.
		Pre-arcing	Clearing at 150 Vac		
150 Vac/dc (UL)	70	470	4000	6.9	FWA-70B
	80	670	6000	7.7	FWA-80B
	100	1200	12,000	9.0	FWA-100B
	125	1870	18,000	11.2	FWA-125B
	150	2700	26,000	13.5	FWA-150B
	200	4780	45,000	17.6	FWA-200B
	250	7470	70,000	22.5	FWA-250B
	300	10,760	100,000	27.0	FWA-300B
	350	15,700	140,000	30.6	FWA-350B
	400	20,300	180,000	35.2	FWA-400B
	500	39,000	120,000	35.0	FWA-500A
	600	46,000	140,000	47.0	FWA-600A
	700	75,000	220,000	49.0	FWA-700A
80 Vdc	1000	170,000	510,000	60.0	FWA-1000A

* Watts loss at rated current.

Dimensions — mm

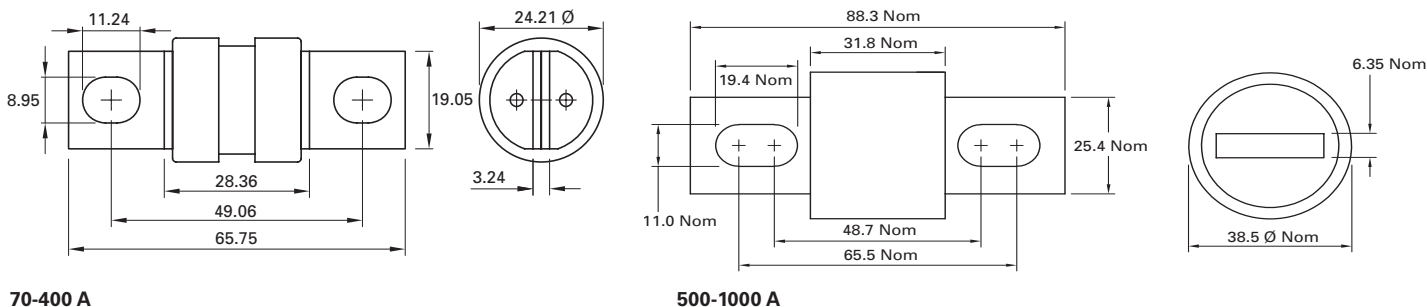

For details on electrical characteristics, contact Application Engineering and ask for data sheets: 720002, 5785310

FWX

250 Vac/dc (UL), 35 to 2500 A

Description

North American style bolted tags and flush-end high speed fuses for the protection of DC common bus, DC drives, power converters/rectifiers and reduced rated voltage starters.



Specifications

Ratings

- Volts: 250 Vac/dc (UL)
- Amps: 35-2500 A
- Interrupting rating:
 - 200 kA RMS Sym.
 - 20 kA at 250 Vdc (35-800 A)

Agency information

- UL Recognized JFHR2, E56412
- CSA Class 1422-30, (53787) on 35-800 A fuses (20 kA IR at 250 Vdc)
- CE

Dimensions – in

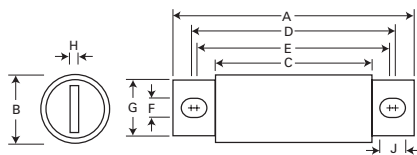

250 Vac/dc (UL)

35-800 A

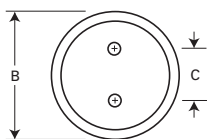

1000-1200 A

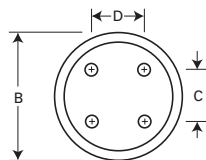

1500-2500 A

* Watts loss at rated current.

Rated voltage	I ² t (A ² s)		Clearing at 250 Vac	Watts loss (W)*	Catalog no.
	Rated current (amps)	Pre-arcing			
	35	50	230	4.2	FWX-35A
	40	60	310	5.2	FWX-40A
	45	80	390	5.7	FWX-45A
	50	100	520	6.0	FWX-50A
	60	140	740	8.1	FWX-60A
	70	330	1400	7.2	FWX-70A
	80	430	1850	8.1	FWX-80A
	90	570	2450	9.0	FWX-90A
	100	740	3150	10.0	FWX-100A
	125	1130	4850	12.5	FWX-125A
	150	1620	6950	15.7	FWX-150A
	175	2170	9300	18.5	FWX-175A
	200	2790	12,000	22.0	FWX-200A
	225	3210	14,700	24.0	FWX-225A
	250	3960	18,100	27.0	FWX-250A
	275	4720	21,600	31.0	FWX-275A
	300	6000	27,300	32.0	FWX-300A
	350	10,600	48,600	39.0	FWX-350A
	400	14,500	66,100	44.0	FWX-400A
	450	22,100	101,000	49.0	FWX-450A
	500	28,000	128,000	54.0	FWX-500A
	600	41,100	188,000	62.0	FWX-600A
	700	48,800	190,000	72.0	FWX-700A
	800	59,000	230,000	84.0	FWX-800A
	1000	44,000	360,000	100.0	FWX-1000AH
	1200	92,000	750,000	103.0	FWX-1200AH
	1500	120,000	880,000	140.0	FWX-1500AH
	1600	160,000	1,200,000	140.0	FWX-1600AH
	2000	320,000	2,300,000	151.0	FWX-2000AH
	2500	670,000	4,700,000	163.0	FWX-2500AH

Amp range	A	B	C	D	E	F	G	H	J	Thread depth
35-60	3.19	0.81	1.59	2.59	2.25	0.34	0.63	0.13	0.52	—
70-200	3.13	1.22	1.59	2.44	2.19	0.34	1.00	0.19	0.47	—
225-600	3.84	1.50	1.59	2.94	2.25	0.41	1.00	0.25	0.75	—
700-800	3.84	2.00	1.59	3.03	2.28	0.41	1.50	0.25	0.78	—
1000-1200	2.59	3.00	1.50	—	—	—	—	—	—	3/8-24 x 1/2" UNF
1500-2500	2.59	3.50	1.50	1.50	—	—	—	—	—	

1" = 25.4 mm

For details on electrical characteristics, contact Application Engineering and ask for data sheets: 720005, 359 (35-800 A), 5785299 (100-2500 A)

North American fuses

FWH

500 Vac/dc (UL), 35 to 1600 A

Description

North American style bolted tags high speed fuses, for the protection of DC common bus, power converters/rectifiers and reduced rated voltage starters.

Specifications

Ratings

- Volts:
 - 500 Vac (UL)
 - 500 Vdc (35-800 A only)
- Amps: 35-1600 A
- Interrupting rating:
 - 200 kA RMS Sym.
 - 50 kA at 500 Vdc

Agency information

- UL Recognized JFHR2, E91958, FWH_B (35-200 A) and FWH_A (1000 and 1200 A), JFHR2, E56412 FWH_A (225-800 A)
- CSA Class 1422-30, File 53787 (35-1600 A)
- CE

Dimensions — in

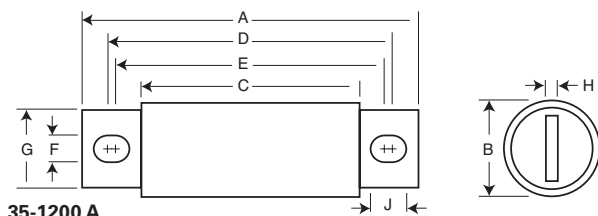

35-1200 A

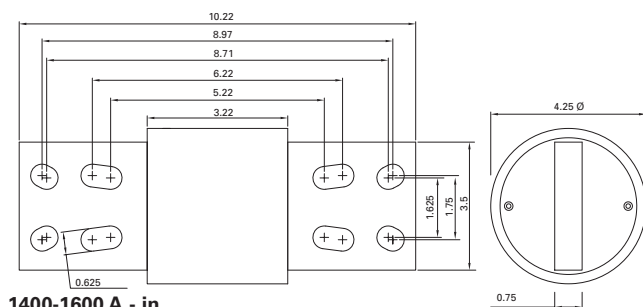

1400-1600 A - in

Amp range	A	B	C	D	E	F	G	H	J
35-60	3.19	0.81	1.59	2.54	2.19	0.34	0.72	0.13	0.52
70-100	3.62	0.95	1.74	2.85	2.81	0.35	0.75	0.13	0.38
125-200	3.62	1.16	1.84	2.89	2.77	0.34	1.00	0.19	0.41
225-400	4.34	1.50	2.09	3.44	2.75	0.41	1.00	0.25	0.75
450-600	4.34	2.00	2.09	3.53	2.78	0.41	1.50	0.25	0.78
700-800	6.34	2.50	2.09	4.97	3.44	0.53	2.00	0.38	1.30
1000-1200	6.97	3.00	3.22	5.47	4.48	0.62	2.38	0.44	1.12
1400-1600	Refer to drawing								

1" = 25.4 mm



Rated voltage	Rated current (amps)	I ² t (A ² s)		Watts loss (W)*	Catalog no.
		Pre-arcing	Clearing at 250 Vac		
500 Vac/ dc (UL)	35	34	150	8.0	FWH-35B
	40	76	320	7.5	FWH-40B
	45	105	450	7.5	FWH-45B
	50	135	670	7.5	FWH-50B
	60	210	900	9.9	FWH-60B
	70	210	900	10.6	FWH-70B
	80	305	1400	12.7	FWH-80B
	90	360	1600	15.0	FWH-90B
	100	475	2000	17.0	FWH-100B
	125	800	3500	25.0	FWH-125B
	150	1100	4600	30.0	FWH-150B
	175	1450	6200	35.0	FWH-175B
	200	1900	8500	40.0	FWH-200B
	225	4600	23,300	39.0	FWH-225A
	250	6300	32,200	41.0	FWH-250A
275	7900	40,300	46.0	FWH-275A	
300	9800	49,800	51.0	FWH-300A	
325	13,700	63,800	53.0	FWH-325A	
350	14,500	72,900	58.0	FWH-350A	
400	19,200	96,700	65.0	FWH-400A	
450	24,700	127,000	74.0	FWH-450A	
500	29,200	149,000	84.0	FWH-500A	
600	41,300	206,000	108.0	FWH-600A	
700	55,000	298,000	120.0	FWH-700A	
800	76,200	409,000	129.0	FWH-800A	
1000	92,000	450,000	145.0	FWH-1000A	
1200	122,000	600,000	180.0	FWH-1200A	
1400	200,000	1,000,000	210.0	FWH-1400A	
1600	290,000	1,400,000	230.0	FWH-1600A	

* Watts loss at rated current.

For details on electrical characteristics, contact Application Engineering and ask for data sheets: 720007, 360 (225-800 A), 5785304 (35-200 A, 1000-1600 A)

KAC

600 Vac (UL), 1 to 1000 A

Description

North American style bolted tags high speed fuses. These fuses are supplied as replacements only. For new installations, Eaton recommends the 700 V FWP see page 19.

Specifications

Ratings

- Volts: 600 Vac (UL)
- Amps: 1-1000 A
- Interrupting rating: 200 kA RMS Sym.

Agency information

- UL Recognized JFHR2, E56413 (1-600 A only)
- CE



Rated voltage	Rated current (amps)	Catalog no.
	1	KAC-1
	2	KAC-2
	3	KAC-3
	4	KAC-4
	5	KAC-5
	6	KAC-6
	7	KAC-7
	8	KAC-8
	9	KAC-9
	10	KAC-10
	12	KAC-12
	15	KAC-15
	17.5	KAC-17.5
	20	KAC-20
	25	KAC-25
	30	KAC-30
	35	KAC-35
	40	KAC-40
	45	KAC-45
	50	KAC-50
600 Vac (UL)	60	KAC-60
	70	KAC-70
	80	KAC-80
	90	KAC-90
	100	KAC-100
	110	KAC-110
	125	KAC-125
	150	KAC-150
	175	KAC-175
	200	KAC-200
	225	KAC-225
	250	KAC-250
	300	KAC-300
	350	KAC-350
	400	KAC-400
	450	KAC-450
	500	KAC-500
	600	KAC-600
	700	KAC-700
	800	KAC-800
	1000	KAC-1000

Dimensions — in

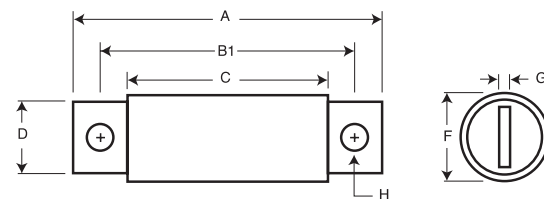

1-30 A and 450-1000 A

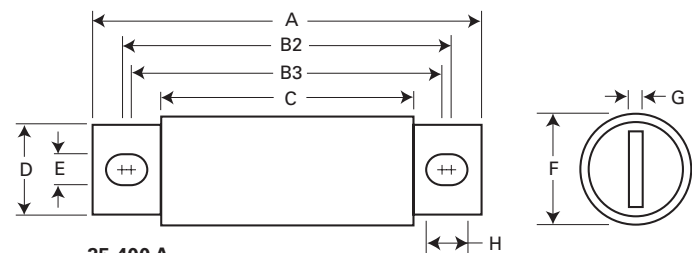

35-400 A

Rated current (amps)	A	B1	B2	B3	C	D	E	F	G	H
1-30	2.88	2.50	—	—	1.88	0.41	—	0.56	0.06	0.26
35-60	4.38	—	3.75	3.50	2.75	0.63	0.34	0.81	0.09	0.47
70-100	5.00	—	4.06	3.66	2.75	0.75	0.41	1.00	0.13	0.61
110-200	5.14	—	4.39	3.77	2.91	1.00	0.41	1.50	0.19	0.72
225-400	6.18	—	4.82	4.57	3.00	1.63	0.56	2.00	0.25	0.69
450-800	6.25	4.75	—	—	3.06	2.00	—	2.50	0.25	0.56
1000	7.25	4.75	—	—	3.06	2.75	—	3.50	0.38	0.56

1" = 25.4 mm

North American fuses

KBC

600 Vac (UL), 35 to 800 A

Description

North American style bolted tags and flush-end high speed fuses. These fuses are supplied as replacements only. For new installations, Eaton recommends the 700 V FWP fuses, see page 19.

Specifications

Ratings

- Volts: 600 Vac (UL)
- Amps: 35-800 A
- Interrupting rating: 200 kA RMS Sym.

Agency information

- UL Recognized JFHR2, E56412 (35-600 A only)
- CE

Rated voltage	Rated current (amps)	Catalog no.
600 Vac (UL)	35	KBC-35
	40	KBC-40
	45	KBC-45
	50	KBC-50
	60	KBC-60
	70	KBC-70
	80	KBC-80
	90	KBC-90
	100	KBC-100
	110	KBC-110
	125	KBC-125
	150	KBC-150
	175	KBC-175
	200	KBC-200
	225	KBC-225
	250	KBC-250
300	KBC-300	
350	KBC-350	
400	KBC-400	
450	KBC-450	
500	KBC-500	
600	KBC-600	
800	KBC-800	



Dimensions — in

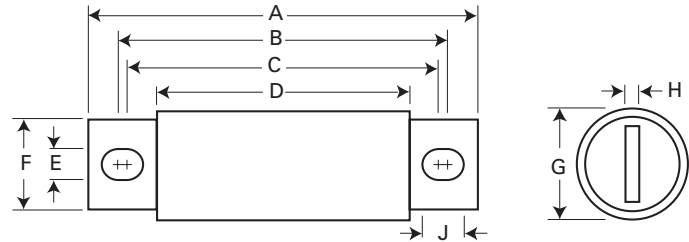

35-60 and 110-600 A

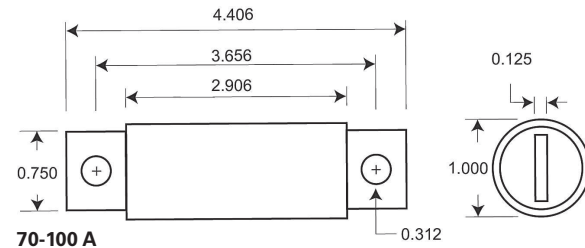

70-100 A

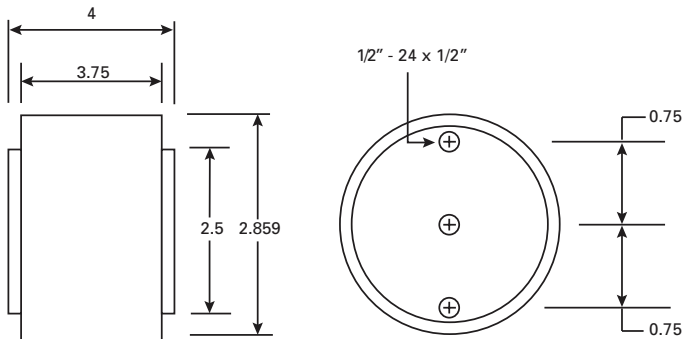

800 A

Rated current (amps)	A	B	C	D	E	F	G	H	J
35-60	4.38	3.75	3.50	2.75	0.34	0.63	0.81	0.09	0.47
70-100	Refer to drawing								
110-200	4.41	3.72	3.59	2.91	0.31	0.88	1.22	0.19	0.38
225-400	5.13	4.19	3.56	2.91	0.41	1.00	1.50	0.25	0.72
450-600	5.13	4.39	3.69	2.88	0.41	1.50	2.00	0.25	0.76
800	Refer to drawing								

1" = 25.4 mm

FWP

700 Vac/dc (UL), 5 to 1200 A

Description

North American style bolted tags high speed fuses for the protection of DC common bus, DC drives, power converters/rectifiers, reduced rated voltage starters.

Specifications

Ratings

- Volts: 700 Vac/dc (UL)
- Amps: 5-1200 A
- Interrupting rating:
 - 200 kA RMS Sym.
 - 50 kA at 700 Vdc (Type A)
 - 50 kA at 500 Vdc (Type B)

Agency information

- UL Recognized JFHR2, E91958 FWP-_B (5-100 A, 700-1200 A), JFHR2, E56412 FWP-_A (125-600 A)
- CSA Class 1422-30, (53787) on 5-800 A
- CE



Rated voltage	Rated current (amps)	I^2t (A ² s)			Watts loss (W)*	Catalog no.
		Pre-arcing	Clearing at 700 Vac			
700 Vac/dc (UL)	5	1.6	11	1.5	FWP-5B	
	10	3.6	22	4.0	FWP-10B	
	15	10.0	70	5.5	FWP-15B	
	20	26.0	180	6.0	FWP-20B	
	25	44.0	320	7.0	FWP-25B	
	30	58.0	450	9.0	FWP-30B	
	35	34.0	160	12.0	FWP-35B	
	40	76.0	320	12.0	FWP-40B	
	50	135.0	600	12.0	FWP-50B	
	60	210.0	950	15.5	FWP-60B	
	70	305.0	2000	18.0	FWP-70B	
	80	360.0	2400	21.0	FWP-80B	
	90	415.0	2700	25.0	FWP-90B	
	100	540.0	3500	27.0	FWP-100B	
	125	1800.0	7300	28.0	FWP-125A	
	150	2900.0	11,700	32.0	FWP-150A	
	175	4200.0	16,700	35.0	FWP-175A	
	200	5500.0	22,000	43.0	FWP-200A	
	225	7700.0	31,300	45.0	FWP-225A	
	250	10,500.0	42,500	48.0	FWP-250A	
300	17,600.0	71,200	58.0	FWP-300A		
350	23,700.0	95,600	65.0	FWP-350A		
400	31,000.0	125,000	78.0	FWP-400A		
450	36,400.0	137,000	94.0	FWP-450A		
500	45,200.0	170,000	107.0	FWP-500A		
600	66,700.0	250,000	122.0	FWP-600A		
700	54,000.0	300,000	125.0	FWP-700A		
800	78,000.0	450,000	140.0	FWP-800A		
900	91,500.0	530,000	150.0	FWP-900A		
1000	120,000.0	600,000	170.0	FWP-1000A		
1200	195,000.0	1,100,000	190.0	FWP-1200A		

* Watts loss at rated current.

For details on electrical characteristics, contact Application Engineering and ask for data sheets: 720012, 5785316 (5-30 A), 361 (125-600 A), 5785308 (35-100 A, 700-1200 A)

North American fuses

FWP

700 Vac/dc (UL), 5 to 1200 A

Dimensions — in

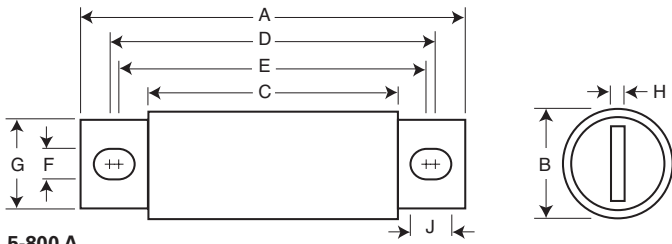

5-800 A

Amp range	A	B	C	D	E	F	G	H	J
5-30	2.87	0.56	1.86	2.48	2.48	0.25	0.41	0.06	0.25
35-60	4.38	0.81	2.75	3.71	3.31	0.34	0.73	0.13	0.54
70-100	4.41	0.95	2.59	3.63	3.56	0.34	0.75	0.13	0.38
125-200	5.09	1.50	2.84	4.19	3.5	0.41	1.00	0.25	0.75
225-400	5.09	2.00	2.84	4.28	3.53	0.41	1.50	0.25	0.78
450-600	7.09	2.50	2.84	5.72	4.19	0.53	2.00	0.38	1.30
700-800	6.63	2.00	2.76	5.56	5.06	0.63	1.50	0.25	0.88
900-1000	Refer to drawing								
1200	Refer to drawing								

1" = 25.4 mm

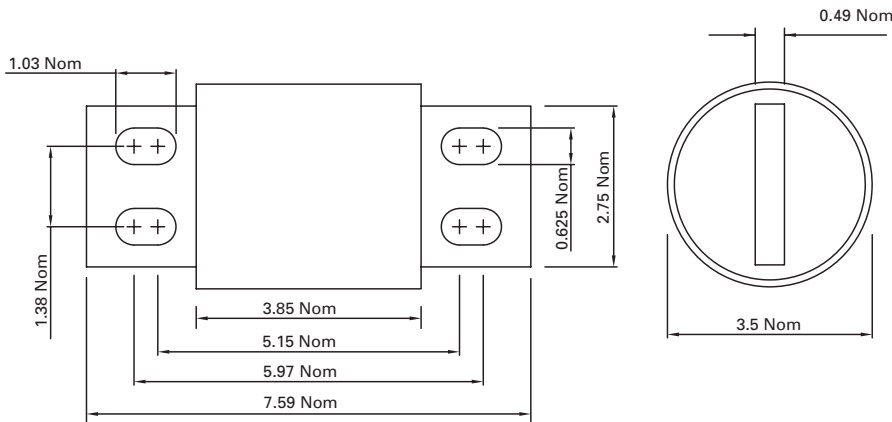

900-1000 A - mm

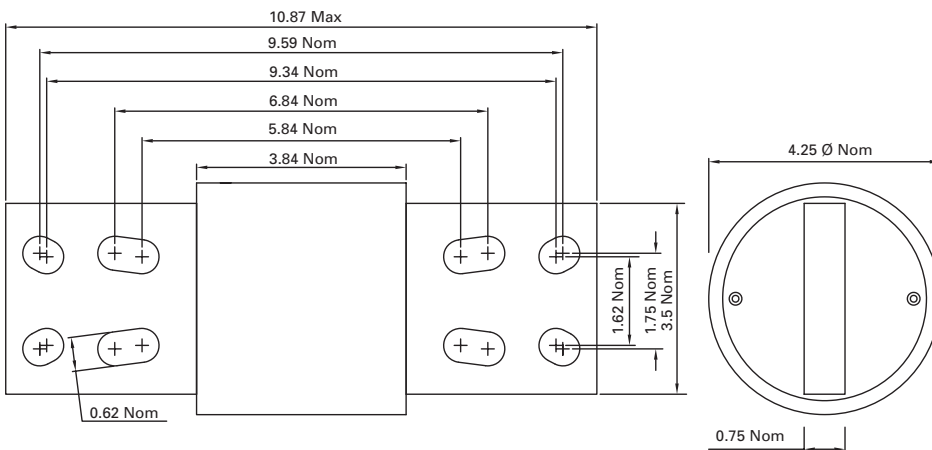

1200 A - mm

For details on electrical characteristics, contact Application Engineering and ask for data sheets: 720012, 5785316 (5-30 A), 361 (125-600 A), 5785308 (35-100 A, 700-1200 A)

FWJ

1000 Vac /800 Vdc (UL), 35 to 2000 A

Description

North American style bolted tags high speed fuses for the protection of DC common bus, DC drives power converters/rectifiers, reduced rated voltage starters.

Specifications

Ratings

- Volts:
 - 1000 Vac (UL)
 - 800 Vdc (UL)
- Amps: 35-2000 A
- Interrupting rating:
 - 25 kA RMS Sym. (35-200 A)
 - 100 kA RMS Sym. (250-2000 A)
 - 50 kA at 800 Vdc (35-200 A and 450-600 A)

Agency information

- UL Recognized JFHR8, E91958 on 50-600 A only
- CE

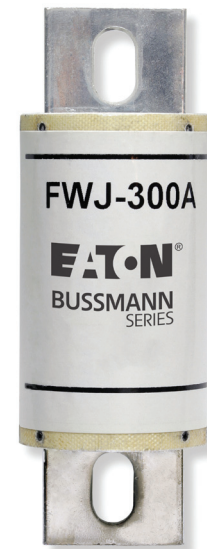

Rated voltage	Rated current (amps)	I ² t (A ² s)		Watts loss (W)*	Catalog no.
		Pre-arcing	Clearing at 1000 Vac		
	35	210	2000	7	FWJ-35A
	40	300	2500	8	FWJ-40A
	50	470	3500	10	FWJ-50A
	60	670	5000	11	FWJ-60A
	70	1100	6900	12	FWJ-70A
	80	1550	9700	13	FWJ-80A
	90	1900	12,000	14	FWJ-90A
	100	2800	17,500	15	FWJ-100A
	125	4800	35,000	16	FWJ-125A
	150	6300	45,000	25	FWJ-150A
	175	7500	65,000	30	FWJ-175A
	200	11,700	80,000	32	FWJ-200A
1000 Vac/ 800 Vdc (UL)	250	16,000	112,000	50	FWJ-250A
	300	23,500	164,000	56	FWJ-300A
	350	33,000	231,000	62	FWJ-350A
	400	47,000	330,000	67	FWJ-400A
	500	39,500	329,000	95	FWJ-500A
	600	61,000	520,000	105	FWJ-600A
	800	87,000	500,000	182	FWJ-800A
	1000	190,000	1,100,000	206	FWJ-1000A
	1200	370,000	2,100,000	240	FWJ-1200A
	1400	470,000	2,700,000	248	FWJ-1400A
	1600	700,000	4,000,000	267	FWJ-1600A
	1800	925,000	5,300,000	239	FWJ-1800A
	2000	1,330,000	7,600,000	244	FWJ-2000A

* Watts loss at rated current.

Dimensions — in

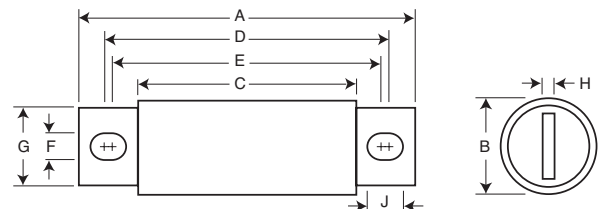

Amp range	A	B	C	D	E	F	G	H	J
35-60	5.00	0.94	3.11	4.24	4.18	0.35	0.75	0.13	0.38
70-100	4.93	1.13	3.09	4.27	4.16	0.35	1.00	0.19	0.41
125-200	5.69	1.53	3.26	4.80	4.06	0.45	1.00	0.25	0.82
250-400	5.77	2.00	3.50	4.81	4.15	0.43	1.50	0.25	0.76
500-600	7.20	2.50	3.47	5.98	4.71	0.56	2.00	0.38	1.20
800-2000	6.81	3.50	3.31	5.47	4.96	0.63	2.75	0.50	0.88

1" = 25.4 mm

For details on electrical characteristics, contact Application Engineering and ask for data sheets: 720027, 5785303 (35-600 A), 5785309 (800-2000 A),

North American fuses

Accessories

Modular fuse blocks

Description

Eaton's Bussmann series offer a comprehensive line of fuse blocks that provide the user with design and manufacturing flexibility. Two identical half blocks make up a Bussmann series modular fuse block. These 'split' units can be panel mounted any distance apart to accommodate any length fuse.

Stud type

The simpler design is the C5268 modular fuse block. With this design, the fuse terminal and cable (with termination) are mounted on the same stud, minimizing labor needed for installation. The stud type block is available in the configurations shown in the table below.

Catalog no.	Max fuse amp rating	Stud
C5268-1	200	5/16-18 x 1"
C5268-2	200	5/16-18 x 1-3/4"
C5268-3	200	5/16-18 x 3/4"
C5268-4	100	1/4-20 x 1"
C5268-5	100	1/4-20 x 1-3/4"

Connector Type

Eaton's Bussmann series also offer a modular style fuse block that utilizes a tin-plated connector for wire termination and heat dissipation), and a plated-steel stud for fuse mounting. The connector type fuse block is available in the configurations shown below. Consult your Bussmann series product representative for additional product details.

Catalog no.	Max rated voltage	Max fuse amp rating
1BS101	600	100
1BS102	600	400
1BS103	600	400
1BS104	600	600

BH

BH fuse blocks provide a wide range of mounting configurations for Bussmann series high speed semiconductors fuses. BH fuse blocks have a short-circuit current rating up to 200 kA RMS Sym.

Catalog no.	Max rated voltage	Max fuse amp rating
BH-0	700	100
BH-1	2500	400
BH-2	5000	600
BH-3	1250	700

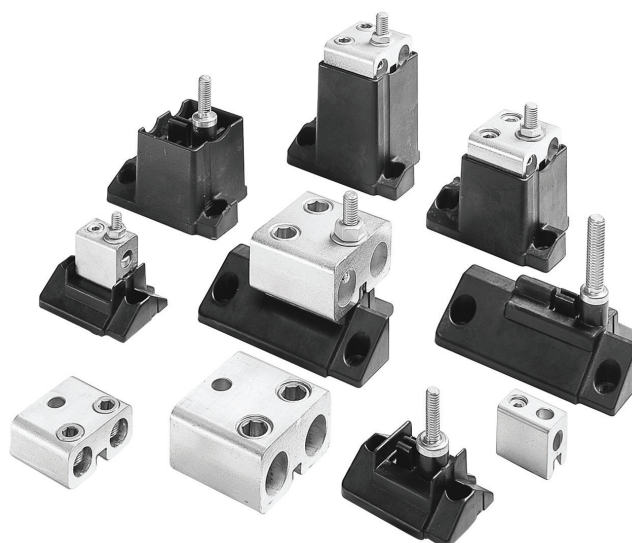
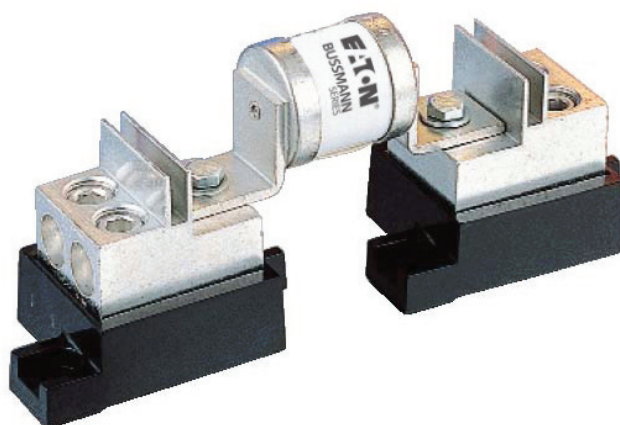
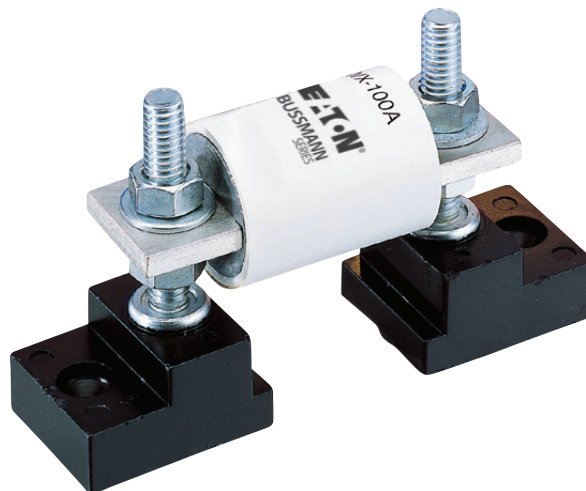

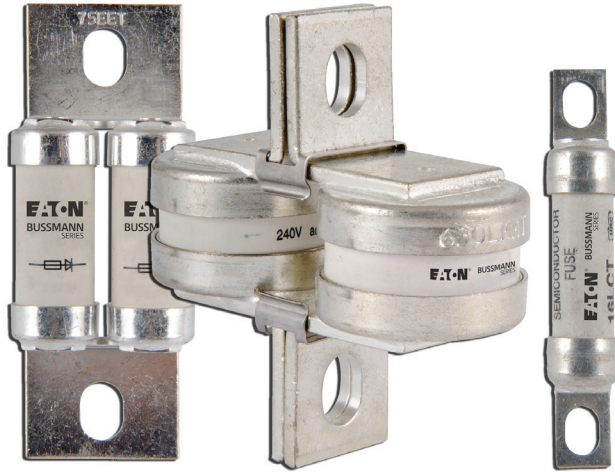

General information

Eaton's Bussmann series wide range of British style high speed fuses and accessories designed and tested to:

- BS 88: Part 4
- IEC 269 Part 4
- UL Recognized

Eaton's Bussmann series British style products use innovative arc quenching techniques and high grade materials to provide:

- Minimal energy let-through (I^2t)
- Excellent DC performance
- Good surge withstand profile

British style fuses are typically found in equipment manufactured in the United Kingdom or British Commonwealth countries. However, North American manufacturers have begun to specify British style fuses — particularly in UPS applications at 240 V or less — to take advantage of their size, performance and cost benefits.

Voltage rating

All Bussmann series British style fuses are tested to IEC 269 Part 4. This standard requires a test voltage which is 5% higher than the rated voltage. In North America, fuses are required to clear only their rated voltage.

Accessories

Trip-indicator fuses are available for use in parallel with the main fuse. Indicator fuses can be attached to the associated fuselink, or mounted separately in panel-mounted fuseclips. In addition, a push-on adapter and microswitch attachment are available, to provide remote indication. Fuse blocks are also available for most applications.

Features and benefits

- Excellent cycling capability
- Excellent DC performance
- Low arc voltage and low energy let-through (I^2t)

Typical applications

- DC common bus
- AC and DC drives
- Power converters/rectifiers
- Reduced voltage starters

British Standard contents

Fuses

Catalog symbol	Amp range	Page
LCT	6-20	24
LET	28-180	24
LMT	160-450	25
LMMT	400-900	25
CT	6-20	26-27
ET	25-80	26-27
FE	35-100	26-27
EET	90-160	26-27
FEE	100-200	26-27
FM	180-350	38-29
FMM	400-700	38-29
MT	160-355	38-29
MMT	180-710	38-29

Accessories

Description	Page
Indicator systems	30
Microswitch adapters	30

British Standard BS88 fuses

LCT, LET

240 Vac/150 Vdc (IEC),

250-280 Vac/150 Vdc (UL), 6 to 180 A

Description

BS88 style bolted tag high speed fuses for the protection of DC common bus, DC drives, power converters/rectifiers and reduced rated voltage starters. Low watts loss in a compact size.

Specifications

Ratings

- Volts:
 - LCT 240 Vac/150 Vdc (IEC), 250 Vac/150 Vdc (UL)
 - LET 280 Vac/150 Vdc (UL, 25-160 A), 250 Vac/150 Vdc (UL 180 A)
- Amps: 6-180 A
- Interrupting rating:
 - 200 kA RMS Sym.
 - 50 kA DC at 125 Vdc
 - 100 kA at 80 Vdc (70-1000 A)

Operating Class: aR.

Agency information

- Designed and tested to BS88 Part 4 and IEC 60269 Part 4
- UL Recognized*
- CCC (LCT only)
- CE

* All fuses have been tested at 318 Vac. Consult Bussmann series product representative for UL Recognized status.



Dimensions — mm

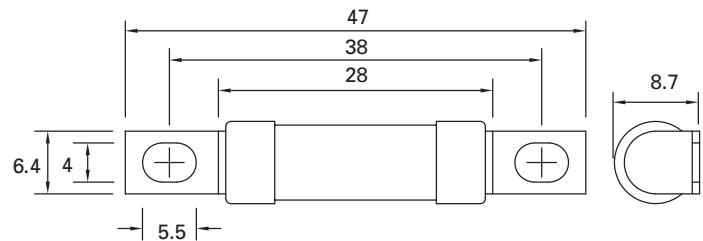

LCT

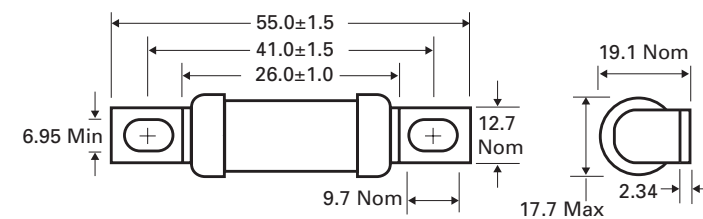

Indicator (optional) 

LET — indicator optional

Fuse symbol	Rated voltage	Rated current (amps)	I ² t (A ² s)		Watts loss (W)*	Catalog no.
			Pre-arcing	Clearing at 240 Vac		
LCT	240 Vac/150 Vdc (IEC) 250 Vac/150 Vdc (UL)	6	2.0	9	1.0	6LCT
		10	3.8	22	2.5	10LCT
		12	7.0	32	2.5	12LCT
		16	20.0	100	2.5	16LCT
		20	25.0	160	4.0	20LCT
LET	280 Vac/150 Vdc (UL)	25	18.0	250	4.0	25LET
		32	32.0	450	5.0	32LET
		35	50.0	600	5.0	35LET
		50	100.0	1400	7.0	50LET
		63	180.0	2200	9.0	63LET
		80	300.0	3800	10.0	80LET
		100	600.0	7500	10.0	100LET
		125	600.0	7500	16.0	125LET
		160	1100.0	16,000	20.0	160LET
		180	1600.0	29,000	21.0	180LET

* Watts loss at rated current.

Note: 7LET, 10LET, 12LET and 16LET are available for replacement purposes on existing equipment.

For details on electrical characteristics, contact Application Engineering and ask for data sheets: 720004, 5785296 (LCT), 5785293 (LET)

LMT, LMMT

240 Vac/150 Vdc (IEC), 250 Vac/150 Vdc (UL), 160 to 900 A

Description

BS88 style bolted tags high speed fuses for the protection of DC common bus, DC drives, power converters/rectifiers and reduced rated voltage starters. Low watts loss in a compact size.

Specifications

Ratings

- Volts:
 - 240 Vac/150 Vdc (IEC)
 - 250 Vac/150 Vdc (UL)
- Amps: 160-900 A
- Interrupting rating:
 - 200 kA RMS Sym., 40 kA at 150 Vdc (IEC)
 - 200 kA RMS Sym., 50 kA at 150 Vdc (UL)



Operating Class: aR.

Agency information

- Designed and tested to BS88 Part 4 and IEC 60269 Part 4
- UL Recognized*
- CCC
- CE

* All fuses have been tested at 318 Vac. Consult Bussmann series product representative for UL Recognized status.

Fuse symbol	Rated voltage	I ² t (A ² s)				Watts loss (W)*	Catalog no.
		Rated current (amps)	Clearing at				
			Pre-arcing	120 Vac	240 Vac		
LMT	240 Vac /150 Vdc (IEC) 250 Vac /150 Vdc (UL)	160	1100	7000	16,000	17	160LMT
		200	1500	10,000	20,000	28	200LMT
		250	3200	20,000	40,000	28	250LMT
		315	6000	35,000	75,000	35	315LMT
		355	8000	50,000	100,000	35	355LMT
		400	14,000	70,000	160,000	40	400LMT
		450	18,000	100,000	220,000	42	450LMT
LMMT	240 Vac /150 Vdc (IEC) 250 Vac /150 Vdc (UL)	400	6000	35,000	80,000	60	400LMMT
		500	14,000	80,000	170,000	64	500LMMT
		630	24,000	150,000	300,000	75	630LMMT
		710	32,000	200,000	460,000	77	710LMMT
		800	52,000	300,000	600,000	82	800LMMT
		900	75,000	400,000	800,000	97	900LMMT

* Watts loss at rated current.

Dimensions — mm

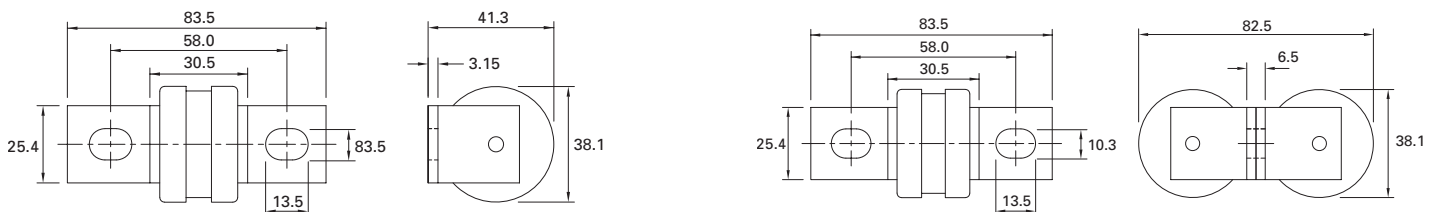

LMT — indicator optional

LMMT — indicator optional

For details on electrical characteristics, contact Application Engineering and ask for data sheets: 720004, 5785294 (LMT), 5785295 (LMMT)