



Chipsmall Limited consists of a professional team with an average of over 10 year of expertise in the distribution of electronic components. Based in Hongkong, we have already established firm and mutual-benefit business relationships with customers from,Europe,America and south Asia,supplying obsolete and hard-to-find components to meet their specific needs.

With the principle of “Quality Parts,Customers Priority,Honest Operation,and Considerate Service”,our business mainly focus on the distribution of electronic components. Line cards we deal with include Microchip,ALPS,ROHM,Xilinx,Pulse,ON,Everlight and Freescale. Main products comprise IC,Modules,Potentiometer,IC Socket,Relay,Connector.Our parts cover such applications as commercial,industrial, and automotives areas.

We are looking forward to setting up business relationship with you and hope to provide you with the best service and solution. Let us make a better world for our industry!



Contact us

Tel: +86-755-8981 8866 Fax: +86-755-8427 6832

Email & Skype: info@chipsmall.com Web: www.chipsmall.com

Address: A1208, Overseas Decoration Building, #122 Zhenhua RD., Futian, Shenzhen, China



Digital Fiber Sensor FX-410 SERIES

Related Information

- General terms and conditions..... F-7
- Sensor selection guide P.3~
- Glossary of terms / General precautions..... P.1455~ / P.1458~
- Korea's S-mark..... P.1506

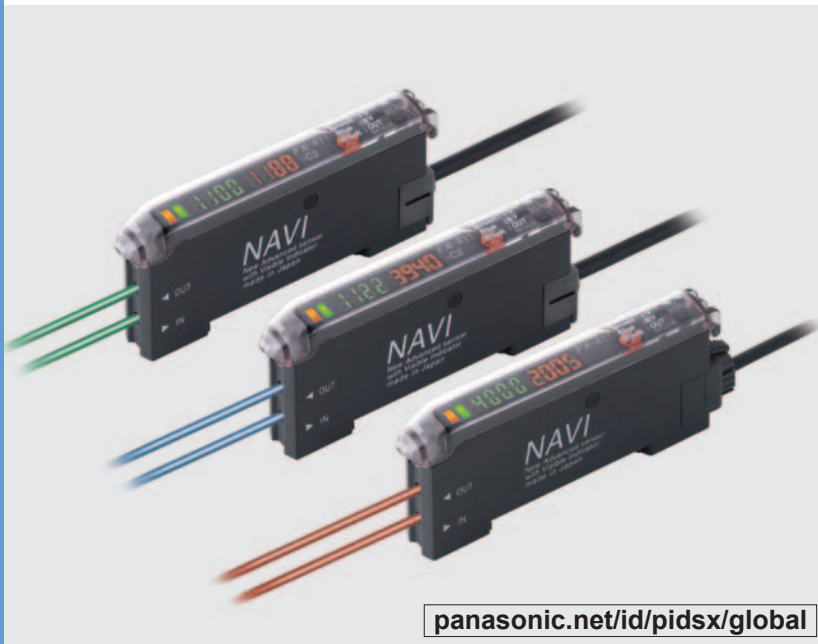

panasonic.net/id/pidsx/global



Just “Look” and “Turn”, Simple, easy-to-use fiber sensor

Incident light intensity and threshold value are displayed simultaneously

The incident light intensity and threshold value can be checked at the same time with no operations needed. In addition, no complex mode settings are needed when the values are adjusted.

Easy-to-understand operating panel layout

The threshold value adjuster and operation mode switch are large and easy to see, and they can be operated with the same sensitivity as general-purpose photoelectric sensors. Functions which are not commonly used can be operated using a non-obtrusive setting switch.

Adjustment variations according to the individual have been eliminated

Accurate control of the adjuster threshold values by using numerical values is possible due to the digital display. This allows anybody to perform the same settings.

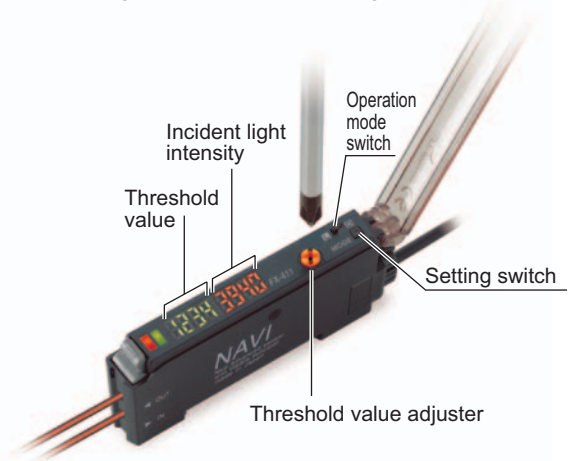

Threshold values can be changed smoothly

This sensor uses the R.S.S.* adjuster with a compact encoder inside. The sensitivity amount changes depending on the rotation speed of the adjuster, so that adjustment can be carried out speedily.

* Rotation Speed Sensitivity

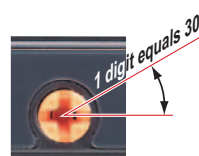
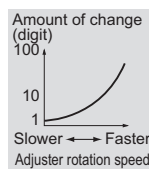
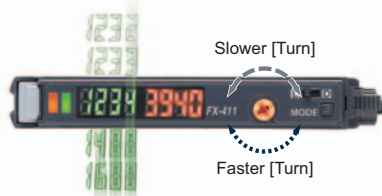

Adjustment in units of 1 digit is also easy
No need for the fine changes in force required for photoelectric sensors.

- FIBER SENSORS
- LASER SENSORS
- PHOTOELECTRIC SENSORS
- MICRO PHOTOELECTRIC SENSORS
- AREA SENSORS
- LIGHT CURTAINS / SAFETY COMPONENTS
- PRESSURE / FLOW SENSORS
- INDUCTIVE PROXIMITY SENSORS
- PARTICULAR USE SENSORS
- SENSOR OPTIONS
- SIMPLE WIRE-SAVING UNITS
- WIRE-SAVING SYSTEMS
- MEASUREMENT SENSORS
- STATIC ELECTRICITY PREVENTION DEVICES
- LASER MARKERS
- PLC
- HUMAN MACHINE INTERFACES
- ENERGY CONSUMPTION VISUALIZATION COMPONENTS
- FA COMPONENTS
- MACHINE VISION SYSTEMS
- UV CURING SYSTEMS

- Selection Guide
- Fibers
- Fiber Amplifiers
- FX-500
- FX-100
- FX-300
- FX-410
- FX-311
- FX-301-F7/ FX-301-F

Large endless adjuster

New concept

Standard screwdrivers can be used to turn the adjuster as well as precision screwdrivers. In addition, an “endless” mechanism is used which eliminates the possibility of any damage being caused by turning the adjuster too far.



FX-412 can be turned by finger!

New concept

The adjuster can be turned directly by finger, without the need for a screwdriver.



Beam power greatly increased to give strong performance under adverse environments

Red LED type

The beam power has been greatly increased. This means a longer sensing distance and less trouble from problems such as dust. These sensors have ample performance for workplace needs.

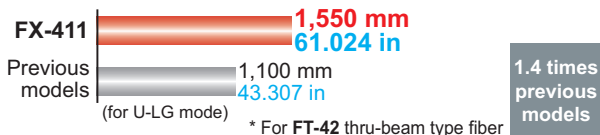

Three types are available, with red, blue and green light

Different sensors can be selected to suit the application.

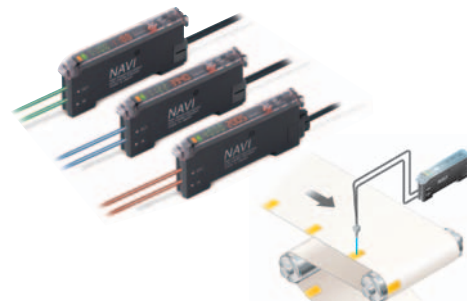

Improved stability over both long and short terms

Red LED type

The red LED type sensors have a “four-chemical emitting element” which maintains stability of light emissions for long-term operation. Furthermore, all models have an “APC (Auto Power Control) circuit” which improves stability at times such as when the power is turned on. These features improve overall stability compared to previous models.

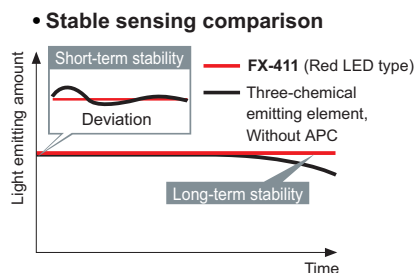

Color combinations that can be discerned during mark sensing

Mark color / Back-ground color	White	Yellow	Orange	Red	Green	Blue	Black
White		•	•	••	•••	•••	•••
Yellow	•		•	•	••	•••	•••
Orange	•	•		••	•••	•••	•••
Red	••	•	•		•	••	••
Green	•••	••	••	•		•	•
Blue	•••	•••	•••	••	•		•
Black	•••	•••	•••	••	•	•	

•:Red LED type •:Blue LED type •:Green LED type

Excellent workability and ease of maintenance

Connector type

The same quick-connection cable that is used for sensors such as the FX-300 series of digital fiber sensors is used. This means that they can be used together with other types of sensors such as laser sensors, and the number of power supply cables can be reduced.

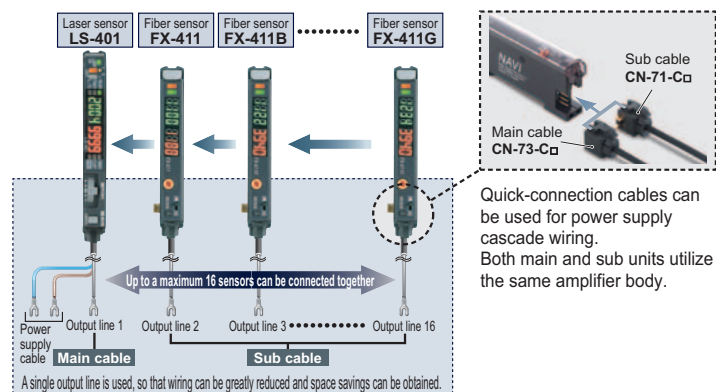

The sensors can be connected together with other sensors such as the FX-300 series of digital fiber sensors and the GA-311 of inductive proximity sensors. In addition, the SC series of sensor PLC connection units with MIL connector compatibility can also be used to further reduce the amount of wiring.

FIBER SENSORS

LASER SENSORS

PHOTOELECTRIC SENSORS

MICRO PHOTOELECTRIC SENSORS

AREA SENSORS

LIGHT CURTAINS / SAFETY COMPONENTS

PRESSURE / FLOW SENSORS

INDUCTIVE PROXIMITY SENSORS

PARTICULAR USE SENSORS

SENSOR OPTIONS

SIMPLE WIRE-SAVING UNITS

WIRE-SAVING SYSTEMS

MEASUREMENT SENSORS

STATIC ELECTRICITY PREVENTION DEVICES

LASER MARKERS

PLC

HUMAN MACHINE INTERFACES

ENERGY CONSUMPTION VISUALIZATION COMPONENTS

FA COMPONENTS

MACHINE VISION SYSTEMS

UV CURING SYSTEMS

Selection Guide

Fibers

Fiber Amplifiers

FX-500

FX-100

FX-300

FX-410

FX-311

FX-301-F7/
FX-301-F

FIBER SENSORS

LASER SENSORS

PHOTOELECTRIC SENSORS

MICRO PHOTOELECTRIC SENSORS

AREA SENSORS

LIGHT CURTAINS / SAFETY COMPONENTS

PRESSURE / FLOW SENSORS

INDUCTIVE PROXIMITY SENSORS

PARTICULAR USE SENSORS

SENSOR OPTIONS

SIMPLE WIRE-SAVING UNITS

WIRE-SAVING SYSTEMS

MEASUREMENT SENSORS

STATIC ELECTRICITY PREVENTION DEVICES

LASER MARKERS

PLC

HUMAN MACHINE INTERFACES

ENERGY CONSUMPTION VISUALIZATION COMPONENTS

FA COMPONENTS

MACHINE VISION SYSTEMS

UV CURING SYSTEMS

Selection Guide

Fibers

Fiber Amplifiers

FX-500

FX-100

FX-300

FX-410

FX-311

FX-301-F7/ FX-301-F

Contributing to device miniaturization

This fiber sensor is the smallest among the dual digital display types, contributing to device miniaturization.

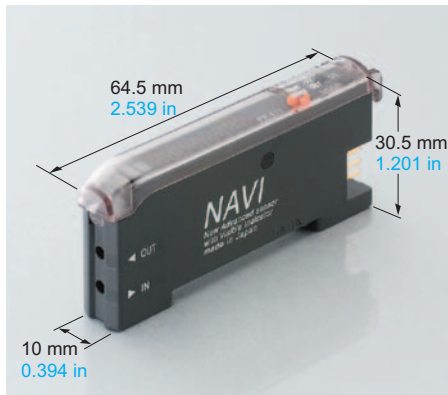

Equipped with 3 types timers

Equipped with OFF-delay / ON-delay / ONE SHOT timer. (Timer period: 1 ms to 3 sec. approx.)

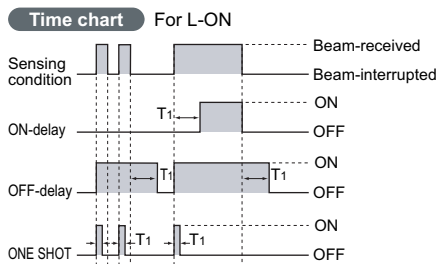

Ideal for dealing with saturation / Light-emitting amount selection function Red LED type New concept

In cases where the incoming light level can become saturated, such as during close-range sensing or when sensing transparent or minute objects, the sensor's light-emitting amount can be adjusted to provide more stable sensing without changing the response time.

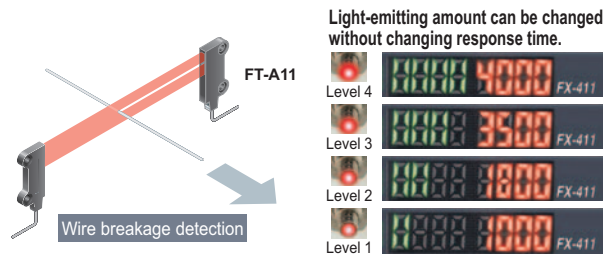

Digital display upside-down / off function

The digital display can be turned upside-down if required to suit the setup location. In addition, a stability indicator is also provided, so that the amount of light-receiving excess can be checked even when the display is turned off.

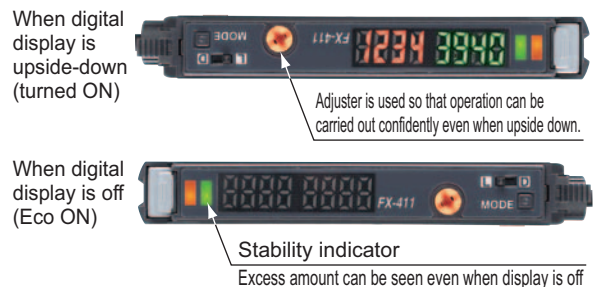

Interference prevention for up to 8 sets fiber heads (for U-LG)

The optical communication function allows up to a maximum of eight sets of fiber heads (four sets for FAST and STD settings) to be installed in contact with each other without mutual interference occurring. (Set automatically when power is turned on.)

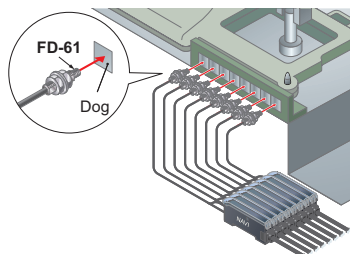

Key lock function prevents wrong operation

This prevents the operator from changing the threshold value by mistake.

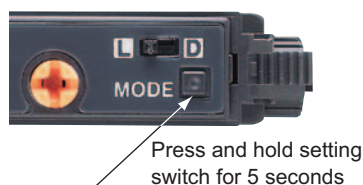

Hold function

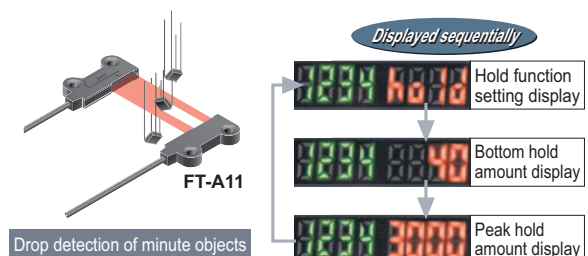

Peak and bottom hold values for the incident light intensity can be displayed. This is useful for checking the incident light intensity during tasks such as drop detection.

In addition, the peak and bottom values can be checked while looking at the threshold value, which makes adjustment much easier.



ORDER GUIDE

Amplifiers Quick-connection cable is not supplied with the amplifier. Please order it separately.

Type	Appearance	Model No.	Emitting element	Output	
NPN output		FX-411	Red LED	NPN open-collector transistor	
		FX-411B	Blue LED		
		FX-411G	Green LED		
PNP output			FX-411P	Red LED	PNP open-collector transistor
			FX-411BP	Blue LED	
			FX-411GP	Green LED	
NPN output			FX-412 (Note)	Red LED	NPN open-collector transistor
			FX-412B (Note)	Blue LED	
			FX-412G (Note)	Green LED	

Note: The **FX-412**□ has a threshold value adjuster that can be adjusted with your fingers.

Quick-connection cables Quick-connection cable is not supplied with the amplifier. Please order it separately.

Type	Model No.	Description	
Main cable (3-core)	CN-73-C1	Length: 1 m 3.281 ft	0.2 mm ² 3-core cabtyre cable, with connector on one end Cable outer diameter: ø3.3 mm ø0.130 in
	CN-73-C2	Length: 2 m 6.562 ft	
	CN-73-C5	Length: 5 m 16.404 ft	
Sub cable (1-core)	CN-71-C1	Length: 1 m 3.281 ft	0.2 mm ² 1-core cabtyre cable, with connector on one end Cable outer diameter: ø3.3 mm ø0.130 in
	CN-71-C2	Length: 2 m 6.562 ft	
	CN-71-C5	Length: 5 m 16.404 ft	

Main cable

- **CN-73-C□**

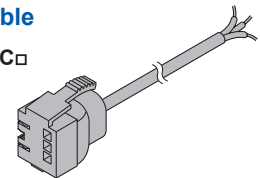

Sub cable

- **CN-71-C□**

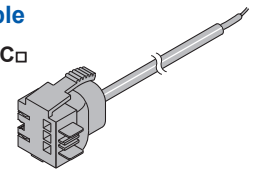

End plates End plates are not supplied with the amplifier. Please order them separately when the amplifiers are mounted in cascade.

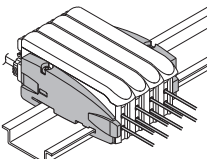
Appearance	Model No.	Description
	MS-DIN-E	When cascading multiple amplifiers, or when it moves depending on the way it is installed on a DIN rail, these end plates clamp amplifiers into place on both sides. Make sure to use end plates when cascading multiple amplifiers together. Two pcs. per set

OPTIONS

Designation	Model No.	Description
Amplifier mounting bracket	MS-DIN-2	Mounting bracket for amplifier
Fiber amplifier protection seal	FX-MB1	10 sets of 2 communication window seals and 1 connector seal Communication window seal: It prevents malfunction due to transmission signal from another amplifier, as well as, prevents effect on another amplifier. Connector seal: It prevents contact of any metal, etc., with the pins of the quick-connection cable.

Amplifier mounting bracket

- **MS-DIN-2**

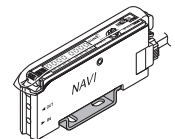

Fiber amplifier protection seal

- **FX-MB1**

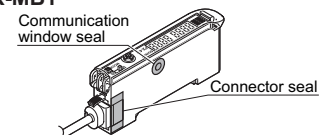

FIBER SENSORS

LASER SENSORS

PHOTO-ELECTRIC SENSORS

MICRO PHOTO-ELECTRIC SENSORS

AREA SENSORS

LIGHT CURTAINS / SAFETY COMPONENTS

PRESSURE / FLOW SENSORS

INDUCTIVE PROXIMITY SENSORS

PARTICULAR USE SENSORS

SENSOR OPTIONS

SIMPLE WIRE-SAVING UNITS

WIRE-SAVING SYSTEMS

MEASUREMENT SENSORS

STATIC ELECTRICITY PREVENTION DEVICES

LASER MARKERS

PLC

HUMAN MACHINE INTERFACES

ENERGY CONSUMPTION VISUALIZATION COMPONENTS

FA COMPONENTS

MACHINE VISION SYSTEMS

UV CURING SYSTEMS

Selection Guide

Fibers

Fiber Amplifiers

FX-500

FX-100

FX-300

FX-410

FX-311

FX-301-F7/

FX-301-F

LIST OF FIBERS

Thru-beam type (one pair set)



Fibers are listed in alphabetic order. Refer to p.5~ "Fiber Selection" for details of each fiber.

Model No.	Sensing range (mm in) (Note 1)									Dimensions
	Red LED			Blue LED			Green LED			
	U-LG	STD	FAST	U-LG	STD	FAST	U-LG	STD	FAST	
FT-140	19,600 771.654 (Note 2)	16,000 629.921	15,000 590.551	14,000 551.181	3,300 129.921	2,200 86.614	9,500 374.016	2,500 98.425	1,800 70.866	P.51
FT-30	600 23.622	145 5.709	95 3.740	90 3.543	24 0.945	15 0.591	45 1.772	12 0.472	8 0.315	P.51
FT-31	540 21.260	140 5.512	85 3.346	85 3.346	20 0.787	14 0.551	38 1.496	10 0.394	7 0.276	P.51
FT-31S	540 21.260	140 5.512	85 3.346	85 3.346	20 0.787	14 0.551	38 1.496	10 0.394	7 0.276	P.51
FT-31W	380 14.961	80 3.150	55 2.165	53 2.087	16 0.630	9 0.354	28 1.102	7 0.276	4 0.157	P.51
FT-40	1,600 62.922	345 13.583	245 9.646	250 9.843	65 2.559	45 1.772	140 5.512	40 1.575	25 0.984	P.51
FT-42	1,550 61.024	340 13.386	240 9.449	230 9.055	60 2.362	40 1.575	125 4.921	33 1.299	22 0.866	P.51
FT-42S	1,550 61.024	340 13.386	240 9.449	230 9.055	60 2.362	40 1.575	125 4.921	33 1.299	22 0.866	P.51
FT-42W	1,300 51.181	290 11.417	210 8.268	220 8.661	57 2.244	33 1.299	110 4.331	32 1.260	19 0.748	P.51
FT-43	2,200 86.614	450 17.717	310 12.205	460 18.110	120 4.724	75 2.953	250 9.843	62 2.441	44 1.732	P.51
FT-45X	1,600 62.992	370 14.567	280 11.024	260 10.236	64 2.520	45 1.772	130 5.118	34 1.339	23 0.906	P.52
FT-A11	3,600 141.732 (Note 2)	2,400 94.488	1,800 70.866	1,300 51.181	350 13.780	220 8.661	770 30.315	190 7.480	120 4.724	P.52
FT-A11W	3,600 141.732 (Note 2)	2,500 98.425	2,000 78.740	1,300 51.181	350 13.780	220 8.661	550 21.654	150 5.906	130 5.118	P.52
FT-A32	3,600 141.732 (Note 2)	3,600 141.732 (Note 2)	3,600 141.732 (Note 2)	2,500 98.425	750 29.528	380 14.961	1,500 59.055	220 8.661	130 5.118	P.52
FT-A32W	3,600 141.732 (Note 2)	3,600 141.732 (Note 2)	3,600 141.732 (Note 2)	3,400 133.858	800 31.496	470 18.504	2,100 82.677	330 12.992	140 5.512	P.52
FT-AL05	1,100 43.307	240 9.449	180 7.087	220 8.661	55 2.165	35 1.378	125 4.921	30 1.181	20 0.787	P.52
FT-E13	30 1.181	7 0.276	5 0.197	2.5 0.098	—	—	1 0.039	—	—	P.52
FT-E23	110 4.331	20 0.787	15 0.591	12 0.472	3 0.118	2 0.079	6 0.236	1 0.039	—	P.52
FT-H13-FM2	1,100 43.307	280 11.024	200 7.874	50 1.969	13 0.512	9 0.354	150 5.906	16 0.630	10 0.394	P.52
FT-H20-J20-S (Note 3)	700 27.559	160 6.299	110 4.331	120 4.724	20 0.787	—	60 2.362	—	—	P.53
FT-H20-J30-S (Note 3)	700 27.559	160 6.299	110 4.331	120 4.724	20 0.787	—	60 2.362	—	—	P.53
FT-H20-J50-S (Note 3)	700 27.559	160 6.299	110 4.331	120 4.724	20 0.787	—	60 2.362	—	—	P.53
FT-H20-M1	550 21.654	150 5.906	100 3.937	100 3.937	25 0.984	20 0.787	65 2.559	17 0.669	12 0.472	P.53
FT-H20-VJ50-S (Note 3)	1,100 43.307	240 9.449	170 6.693	170 6.693	35 1.378	—	90 3.543	—	—	P.53
FT-H20-VJ80-S (Note 3)	1,100 43.307	240 9.449	170 6.693	170 6.693	35 1.378	—	90 3.543	—	—	P.53
FT-H20W-M1	400 15.748	110 4.331	80 3.15	75 2.953	19 0.748	13 0.512	58 2.283	13 0.512	9 0.354	P.53
FT-H30-MV-S (Note 4)	390 15.354	100 3.937	70 2.756	75 2.953	20 0.787	15 0.591	55 2.165	13 0.512	10 0.394	P.53
FT-H35-M2	600 23.622	150 5.906	110 4.331	115 4.528	28 1.102	20 0.787	90 3.543	20 0.787	14 0.551	P.53
FT-H35-M2S6	600 23.622	150 5.906	110 4.331	115 4.528	28 1.102	20 0.787	90 3.543	20 0.787	14 0.551	P.53
FT-HL80Y	3,500 137.795 (Note 2)	800 31.496	550 21.654	150 5.906	35 1.378	20 0.787	200 7.874	55 2.165	35 1.378	P.53
FT-KS40	3,600 141.732 (Note 2)	2,000 78.740	1,900 74.803	1,000 39.370	270 10.630	190 7.480	590 23.228	130 5.118	53 2.087	P.54
FT-KV26	880 34.646	170 6.693	120 4.724	130 5.118	31 1.220	—	90 3.543	18 0.709	—	P.54
FT-KV40	3,600 141.732 (Note 2)	1,700 66.929	1,300 51.181	1,200 47.244	310 12.205	190 7.480	800 31.496	190 7.480	120 4.724	P.54
FT-KV40W	3,600 141.732 (Note 2)	1,600 62.992	1,100 43.307	900 35.433	270 10.630	140 5.512	420 16.535	100 3.937	65 2.559	P.54
FT-L80Y	3,500 137.795 (Note 2)	900 35.433	600 23.622	250 9.843	60 2.362	40 1.575	300 11.811	70 2.756	45 1.772	P.54
FT-R31	380 14.961	79 3.110	56 2.205	80 3.150	20 0.787	13 0.512	38 1.496	10 0.394	7 0.276	P.54
FT-R40	1,200 47.244	240 9.449	170 6.693	200 7.874	50 1.969	32 1.260	100 3.937	28 1.102	19 0.748	P.54
FT-R41W	1,200 47.244	290 11.417	200 7.874	220 8.661	57 2.244	33 1.299	100 3.937	26 1.024	18 0.709	P.54
FT-R42W	3,600 141.732 (Note 2)	990 38.976	740 29.134	310 12.205	75 2.953	58 2.283	270 10.630	70 2.756	50 1.969	P.54
FT-R43	1,200 47.244	230 9.055	160 6.299	200 7.874	50 1.969	32 1.260	100 3.937	26 1.024	18 0.709	P.54
FT-R44Y	1,200 47.244	230 9.055	160 6.299	200 7.874	50 1.969	32 1.260	100 3.937	26 1.024	18 0.709	P.55
FT-R60Y	3,600 141.732 (Note 2)	750 29.528	540 21.260	560 22.047	140 5.512	90 3.543	290 11.417	75 2.953	50 1.969	P.55
FT-S11	150 5.906	30 1.181	20 0.787	21 0.827	5 0.197	3.5 0.138	12 0.472	2 0.079	1.5 0.059	P.55
FT-S20	600 23.622	145 5.709	95 3.740	90 3.543	24 0.945	15 0.591	45 1.772	12 0.472	8 0.315	P.55
FT-S21	540 21.260	140 5.512	85 3.346	85 3.346	20 0.787	14 0.551	38 1.496	10 0.394	7 0.276	P.55

Notes: 1) Note that the sensing range of the free-cut type fiber may be reduced by 20 % max. depending upon how the fiber is cut.

2) The fiber cable length practically limits the sensing range.

3) Heat-resistant joint fibers and ordinary-temperature fibers (FT-42) are sold as a set.

4) Sold as a set comprising vacuum type fiber + photo-terminal (FV-BR1) + fiber at atmospheric side (FT-J8).

LIST OF FIBERS

Thru-beam type (one pair set)



Fibers are listed in alphabetic order. Refer to p.5~ "Fiber Selection" for details of each fiber.

Model No.	Sensing range (mm in) (Note 1)									Dimensions
	Red LED			Blue LED			Green LED			
	U-LG	STD	FAST	U-LG	STD	FAST	U-LG	STD	FAST	
FT-S21W	380 14.961	80 3.150	55 2.165	53 2.087	16 0.630	9 0.354	28 1.102	7 0.276	4 0.157	P.55
FT-S30	1,600 62.992	345 13.583	245 9.646	250 9.843	65 2.559	45 1.772	140 5.512	40 1.575	25 0.984	P.55
FT-S31W	1,300 51.181	290 11.417	210 8.268	220 8.661	57 2.244	33 1.299	110 4.331	32 1.260	19 0.748	P.55
FT-S32	3,600 141.732 (Note 2)	920 36.220	670 26.378	700 27.559	180 7.087	110 4.331	400 15.748	92 3.622	62 2.441	P.55
FT-V23	720 28.346	140 5.512	100 3.937	120 4.724	30 1.181	20 0.787	65 2.559	16 0.630	9 0.354	P.55
FT-V24W	140 5.512	25 0.984	20 0.787	18 0.709	2 0.079	—	5 0.197	—	—	P.56
FT-V25	360 14.173	70 2.756	50 1.969	57 2.244	10 0.394	7 0.276	28 1.102	8 0.315	5 0.197	P.56
FT-V30	770 30.315	160 6.299	120 4.724	210 8.268	47 1.850	28 1.102	100 3.937	22 0.866	10 0.394	P.56
FT-V40	3,600 141.732 (Note 2)	950 37.402	730 28.740	810 31.890	190 7.480	130 5.118	500 19.685	115 4.528	81 3.189	P.56
FT-V80Y	1,500 59.055	350 13.780	250 9.843	240 9.449	55 2.165	35 1.378	180 7.087	38 1.496	24 0.945	P.56
FT-Z20HBW	390 15.354	80 3.150	55 2.165	64 2.520	16 0.630	10 0.394	30 1.181	7 0.276	5 0.197	P.56
FT-Z20W	1,300 51.181	270 10.630	190 7.480	170 6.693	39 1.535	23 0.906	92 3.622	19 0.748	11 0.433	P.56
FT-Z30	3,100 122.047	660 25.984	480 18.898	250 9.843	60 2.362	37 1.457	190 7.480	51 2.008	33 1.299	P.56
FT-Z30E	3,600 141.732 (Note 2)	1,200 47.244	920 36.220	960 37.795	250 9.843	160 6.299	460 18.110	120 4.724	83 3.268	P.56
FT-Z30EW	3,600 141.732 (Note 2)	590 23.228	430 16.929	940 37.008	180 7.087	110 4.331	400 15.748	85 3.346	56 2.205	P.57
FT-Z30H	3,600 141.732 (Note 2)	1,300 51.181	950 37.402	1,100 43.307	290 11.417	170 6.693	580 22.835	150 5.906	100 3.937	P.57
FT-Z30HW	3,600 141.732 (Note 2)	1,300 51.181	950 37.402	940 37.008	180 7.087	110 4.331	400 15.748	85 3.346	56 2.205	P.57
FT-Z30W	2,400 94.488	540 21.260	390 15.354	180 7.087	45 1.772	28 1.102	160 6.299	34 1.339	21 0.827	P.57
FT-Z40HBW	1,300 51.181	290 11.417	210 8.268	220 8.661	57 2.244	33 1.299	110 4.331	32 1.260	19 0.748	P.57
FT-Z40W	2,200 86.614	460 18.110	340 13.386	380 14.961	90 3.543	63 2.480	170 6.693	45 1.772	30 1.181	P.57
FT-Z802Y	3,500 137.795 (Note 2)	750 29.528	540 21.260	450 17.717	110 4.331	80 3.150	300 11.811	80 3.150	60 2.362	P.57

Notes: 1) Note that the sensing range of the free-cut type fiber may be reduced by 20 % max. depending upon how the fiber is cut.
 2) The fiber cable length practically limits the sensing range.

Retroreflective type



Fibers are listed in alphabetic order. Refer to p.5~ "Fiber Selection" for details of each fiber.

Model No.	Sensing range (mm in) (Note 1,2)									Dimensions
	Red LED			Blue LED			Green LED			
	U-LG	STD	FAST	U-LG	STD	FAST	U-LG	STD	FAST	
FR-KZ22E	15 to 350 0.591 to 13.780	15 to 140 0.591 to 5.512	15 to 100 0.591 to 3.937	20 to 100 0.787 to 3.937	—	—	—	—	—	P.58
FR-KZ50E	20 to 400 0.787 to 15.748	20 to 200 0.787 to 7.874	20 to 200 0.787 to 7.874	20 to 200 0.787 to 7.874	20 to 84 0.787 to 3.307	20 to 45 0.787 to 1.771	20 to 180 0.787 to 7.087	20 to 55 0.787 to 1.969	—	P.58
FR-KZ50H	20 to 400 0.787 to 15.748	20 to 200 0.787 to 7.874	20 to 200 0.787 to 7.874	20 to 145 0.787 to 5.709	20 to 47 0.787 to 1.850	20 to 26 0.787 to 1.024	20 to 145 0.787 to 5.709	20 to 47 0.787 to 1.850	20 to 26 0.787 to 1.024	P.58
FR-Z50HW	100 to 1,000 3.937 to 39.370	100 to 540 3.937 to 21.260	100 to 460 3.937 to 18.110	100 to 490 3.937 to 19.291	—	—	—	—	—	P.58

Notes: 1) Note that the sensing range of the free-cut type fiber may be reduced by 20 % max. depending upon how the fiber is cut.
 The sensing range of **FR-KZ22E** is specified for the attached reflector.
 The sensing range of **FR-KZ50E** and **FR-KZ50H** is specified for the attached reflector **RF-003**. The sensing range of **FR-Z50HW** is specified for the **RF-13**.
 2) The sensing range is the possible setting range for the attached reflector. The fiber can detect an object less than setting range for the reflector.
 However, note that if there are any white or highly-reflective surfaces near the fiber head, reflected incident light may affect the fiber head. If this occurs, adjust the threshold value of the amplifier unit before use.

Sensing range when using in combination with FR-Z50HW reflector (Optional)

The sensing ranges are the value for red LED types.

Reflector Model No.	Sensing range (mm in)		
	FX-411		
	U-LG	STD	FAST
RF-230	100 to 12,000 3.937 to 47.244	100 to 1,700 3.937 to 66.929	100 to 1,300 3.937 to 51.181
RF-220	100 to 2,200 3.937 to 8.661	100 to 950 3.937 to 37.402	100 to 730 3.937 to 28.740
RF-210	100 to 2,100 3.937 to 82.677	100 to 780 3.937 to 30.709	100 to 620 3.937 to 24.409

Note: The sensing range is the possible setting range for the reflector. The fiber can detect an object less than setting range for the reflector. However, note that if there are any white or highly-reflective surfaces near the fiber head, reflected incident light may affect the fiber head. If this occurs, adjust the threshold value of the amplifier unit before use.

FIBER SENSORS

LASER SENSORS

PHOTO-ELECTRIC SENSORS

MICRO PHOTO-ELECTRIC SENSORS

AREA SENSORS

LIGHT CURTAINS / SAFETY COMPONENTS

PRESSURE / FLOW SENSORS

INDUCTIVE PROXIMITY SENSORS

PARTICULAR USE SENSORS

SENSOR OPTIONS

SMALL WIRE-SAVING UNITS

WIRE-SAVING SYSTEMS

MEASUREMENT SENSORS

STATIC ELECTRICITY PREVENTION DEVICES

LASER MARKERS

PLC

HUMAN MACHINE INTERFACES

ENERGY CONSUMPTION VISUALIZATION COMPONENTS

FA COMPONENTS

MACHINE VISION SYSTEMS

UV CURING SYSTEMS

Selection Guide

Fibers

Fiber Amplifiers

FX-500

FX-100

FX-300

FX-410

FX-311

FX-301-F7/
FX-301-F

LIST OF FIBERS

Reflective type



Fibers are listed in alphabetic order. Refer to p.5~ "Fiber Selection" for details of each fiber.

Model No.	Sensing range (mm in) (Note 1, 2) / Description										Dimensions
	Red LED			Blue LED			Green LED				
	U-LG	STD	FAST	U-LG	STD	FAST	U-LG	STD	FAST		
FD-30	200 7.874	48 1.890	35 1.378	40 1.575	9 0.354	6 0.236	18 0.709	5 0.197	3 0.118		P.59
FD-31	175 6.890	45 1.772	34 1.339	35 1.378	8 0.315	5 0.197	16 0.630	4 0.157	2 0.079		P.59
FD-31W	120 4.724	20 0.787	15 0.591	16 0.630	3 0.118	1 to 2.5 0.039 to 0.098	7 0.276	1 to 2.5 0.039 to 0.098	—————		P.59
FD-32G	240 9.449	52 2.047	38 1.496	48 1.890	11 0.433	8 0.315	24 0.945	5 0.197	4 0.157		P.59
FD-32GX	320 12.598	50 1.969	38 1.496	50 1.969	12 0.472	9 0.354	24 0.945	7 0.276	4 0.157		P.59
FD-40	200 7.874	48 1.890	35 1.378	40 1.575	9 0.354	6 0.236	18 0.709	5 0.197	3 0.118		P.59
FD-41	175 6.890	45 1.772	34 1.339	35 1.378	8 0.315	5 0.197	16 0.630	4 0.157	2 0.079		P.59
FD-41S	175 6.890	40 1.575	30 1.181	35 1.378	8 0.315	5 0.197	16 0.630	4 0.157	2 0.079		P.59
FD-41SW	120 4.724	20 0.787	15 0.591	18 0.709	1 to 4 0.039 to 0.157	1 to 2.5 0.039 to 0.098	12 0.472	1 to 2.5 0.039 to 0.098	—————		P.59
FD-41W	330 12.992	70 2.756	50 1.969	54 2.126	0.5 to 13 0.020 to 0.512	1 to 8 0.039 to 0.315	29 1.142	1.5 to 7 0.059 to 0.276	1.5 to 4.5 0.059 to 0.177		P.59
FD-42G	240 9.449	52 2.047	38 1.496	48 1.890	11 0.433	8 0.315	24 0.945	5 0.197	4 0.157		P.60
FD-42GW	240 9.449	40 1.575	30 1.181	30 1.181	7 0.276	5 0.197	15 0.591	4 0.157	2 0.079		P.60
FD-60	600 23.622	150 5.906	100 3.937	130 5.118	30 1.181	20 0.787	70 2.756	20 0.787	13 0.512		P.60
FD-61	510 20.079	140 5.512	90 3.543	105 4.134	27 1.063	18 0.709	65 2.559	16 0.630	11 0.433		P.60
FD-61G	460 18.110	110 4.331	80 3.150	105 4.134	27 1.063	18 0.709	55 2.165	15 0.591	9 0.354		P.60
FD-61S	500 19.685	140 5.512	95 3.740	105 4.134	27 1.063	18 0.709	65 2.559	16 0.630	11 0.433		P.60
FD-61W	330 12.992	70 2.756	50 1.969	54 2.126	0.5 to 13 0.020 to 0.512	1 to 8 0.039 to 0.315	29 1.142	1.5 to 7 0.059 to 0.276	1.5 to 4.5 0.059 to 0.177		P.60
FD-62	820 32.283	180 7.087	130 5.118	160 6.299	1 to 44 0.039 to 1.732	1 to 29 0.039 to 1.142	98 3.858	1 to 26 0.039 to 1.024	1 to 18 0.039 to 0.709		P.60
FD-64X	380 14.961	80 3.150	55 2.165	54 2.126	0.5 to 14 0.020 to 0.551	0.5 to 9 0.020 to 0.354	27 1.063	0.5 to 7 0.020 to 0.276	0.5 to 4.5 0.020 to 0.177		P.61
FD-A16	200 7.874	100 3.937	75 2.953	30 1.181	13 0.512	13 0.512	57 2.244	14 0.551	—————		P.61
FD-AL11	460 18.110	100 3.937	70 2.756	70 2.756	17 0.669	10 0.394	45 1.772	9 0.354	6 0.236		P.61
FD-E13	20 0.787	4 0.157	3 0.118	2.5 0.098	0.7 0.028	—————	1.5 0.059	—————	—————		P.61
FD-E23	75 2.953	15 0.591	10 0.394	10 0.394	2.5 0.098	1.5 0.059	5 0.197	1.3 0.051	0.9 0.035		P.61
FD-EG30	90 3.543	15 0.591	10 0.394	10 0.394	2.5 0.098	1.5 0.059	5 0.197	1.3 0.051	0.9 0.035		P.61
FD-EG30S	85 3.346	15 0.591	10 0.394	10 0.394	2.5 0.098	1.5 0.059	5 0.197	1.3 0.051	0.9 0.035		P.62
FD-EG31	25 0.984	5 0.197	4 0.157	4 0.157	1 0.039	0.5 0.020	2 0.079	—————	—————		P.62
FD-F4	Applicable pipe diameter: Outer dia. ø6 to ø26 mm ø0.236 to ø1.024 in transparent pipe [PFA (fluorine resin) or equivalently transparent pipe, wall thickness 1 mm 0.039 in] Liquid absent: Beam received, Liquid present: Beam interrupted										P.62
FD-F41	Applicable pipe diameter: Outer dia. ø6 to ø26 mm ø0.236 to ø1.024 in transparent pipe [PVC (vinyl chloride), fluorine resin, polycarbonate, acrylic, glass, wall thickness 1 to 3 mm 0.039 to 0.118 in] Liquid absent: Beam received, Liquid present: Beam interrupted										P.62
FD-F41Y (Note 3)	ø4 mm ø0.157 in Protective tube: Fluorine resin, length 500 mm 19.685 in (cuttable) Liquid surface not contacted: Beam received, Liquid surface contacted: Beam interrupted										P.62
FD-F8Y	ø6 mm ø0.236 in Protective tube: Fluorine resin, length 1,000 mm 39.370 in (not cuttable) Liquid surface not contacted: Beam received, Liquid surface contacted: Beam interrupted										P.62
FD-FA93	Applicable pipe diameter: Outer dia. ø8 mm ø0.315 in or more transparent pipe (When used with the tying bands: ø8 to ø80 mm ø0.315 to ø3.150 in) [PFA (fluorine resin), including translucent] Liquid absent: Beam received, Liquid present: Beam interrupted										P.62
FD-H13-FM2	430 16.929	100 3.937	70 2.756	40 1.575	10 0.394	7 0.276	40 1.575	10 0.394	7 0.276		P.63
FD-H18-L31	0 to 25 0 to 0.984	0 to 10 0 to 0.394	0 to 8 0 to 0.315	—————	—————	—————	—————	—————	—————		P.63
FD-H20-21	350 13.780	90 3.543	65 2.559	65 2.559	13 0.512	9 0.354	45 1.772	10 0.394	7 0.276		P.63
FD-H20-M1	270 10.630	85 3.346	60 2.362	60 2.362	14 0.551	10 0.394	58 2.283	10 0.394	7 0.276		P.63
FD-H25-L43 (Note 4)	2.5 to 29 0.098 to 1.142	4 to 20 0.157 to 0.787	4 to 16 0.157 to 0.630	—————	—————	—————	—————	—————	—————		P.63
FD-H25-L45 (Note 4)	5 to 42 0.197 to 1.654	7 to 38 0.276 to 1.496	7 to 35 0.276 to 1.437	—————	—————	—————	—————	—————	—————		P.63

Notes: 1) Note that the sensing range of the free-cut type fiber may be reduced by 20 % max. depending upon how the fiber is cut.
 2) The sensing range is specified for white non-glossy paper.
 3) Liquid inflow prevention joint, protective tube extension joint, fiber mounting joint are available. Please refer to p.38 for details.
 4) The sensing range is specified for transparent glass 100 × 100 × t0.7 mm **3.937 × 3.937 × t0.028 in**

- FIBER SENSORS
- LASER SENSORS
- PHOTO-ELECTRIC SENSORS
- MICRO PHOTO-ELECTRIC SENSORS
- AREA SENSORS
- LIGHT CURTAINS/ SAFETY COMPONENTS
- PRESSURE / FLOW SENSORS
- INDUCTIVE PROXIMITY SENSORS
- PARTICULAR USE SENSORS
- SENSOR OPTIONS
- SIMPLE WIRE-SAVING UNITS
- WIRE-SAVING SYSTEMS
- MEASURE-MENT SENSORS
- STATIC ELECTRICITY PREVENTION DEVICES
- LASER MARKERS
- PLC
- HUMAN MACHINE INTERFACES
- ENERGY CONSUMPTION VISUALIZATION COMPONENTS
- FA COMPONENTS
- MACHINE VISION SYSTEMS
- UV CURING SYSTEMS
- Selection Guide
- Fibers
- Fiber Amplifiers
- FX-500**
- FX-100**
- FX-300**
- FX-410**
- FX-311**
- FX-301-F7/ FX-301-F

LIST OF FIBERS

Reflective type



Fibers are listed in alphabetic order. Refer to p.5~ "Fiber Selection" for details of each fiber.

Model No.	Sensing range (mm in) (Note 1, 2) / Description									Dimensions
	Red LED			Blue LED			Green LED			
	U-LG	STD	FAST	U-LG	STD	FAST	U-LG	STD	FAST	
FD-H30-KZ1V-S (Note 3,4)	20 to 300 0.787 to 11.811	25 to 100 0.984 to 3.937	25 to 45 0.984 to 1.772	—	—	—	—	—	—	P.64
FD-H30-L32	0 to 20 0 to 0.787	1 to 8 0.039 to 0.315	1 to 6 0.039 to 0.236	—	—	—	—	—	—	P.64
FD-H30-L32V-S (Note 3,4)	0 to 11 0 to 0.433	1.5 to 5 0.059 to 0.197	2 to 4 0.079 to 0.157	—	—	—	—	—	—	P.64
FD-H35-20S	210 8.268	50 1.969	35 1.378	45 1.772	10 0.394	7 0.276	20 0.787	6 0.236	4 0.157	P.64
FD-H35-M2	300 11.811	83 3.268	60 2.362	50 1.969	12 0.472	9 0.354	50 1.969	10 0.394	7 0.276	P.64
FD-H35-M2S6	300 11.811	80 3.150	50 1.969	50 1.969	14 0.551	10 0.394	40 1.575	10 0.394	7 0.276	P.64
FD-HF40Y (Note 5)	ø4 mm ø0.157 in Protective tube: fluorine resin, length:500 mm 19.685 in (allowable cutting) Liquid surface not contacted: Beam received, Liquid surface contacted: Beam interrupted									P.64
FD-L10 (Note 3)	0 to 4.4 0 to 0.173	0 to 4 0 to 0.157	0 to 3.8 0 to 0.150	3.5 0.138	2.5 0.098	2 0.079	0 to 3 0 to 0.118	1 to 2 0.039 to 0.079	—	P.65
FD-L11 (Note 3)	0 to 10 0 to 0.394	0 to 7 0 to 0.276	0 to 7 0 to 0.276	8.5 0.335	6 0.236	5.5 0.217	8 0.315	5 0.197	—	P.65
FD-L12W (Note 3)	0.5 to 10 0.020 to 0.394	1 to 4.5 0.039 to 0.177	1 to 3.5 0.039 to 0.137	—	—	—	—	—	—	P.65
FD-L20H	1 to 32 0.039 to 1.260	4 to 10 0.157 to 0.394	4.5 to 10 0.177 to 0.394	4 to 13 0.157 to 0.512	5 to 9 0.197 to 0.354	5.5 to 8.5 0.217 to 0.334	5 to 11 0.197 to 0.433	6 to 8.5 0.236 to 0.335	—	P.65
FD-L21 (Note 3)	1 to 18 0.039 to 0.709	3 to 14 0.118 to 0.551	3 to 13 0.118 to 0.512	—	—	—	—	—	—	P.65
FD-L21W (Note 3)	3 to 16 0.118 to 0.630	7 to 12 0.276 to 0.472	7 to 11 0.276 to 0.433	—	—	—	—	—	—	P.65
FD-L22A (Note 3)	0 to 26 0 to 1.024	0 to 23 0 to 0.906	0 to 19 0 to 0.748	—	—	—	—	—	—	P.65
FD-L23 (Note 3)	0 to 30 0 to 1.181	0 to 30 0 to 1.181	0 to 28 0 to 1.102	—	—	—	—	—	—	P.65
FD-L30A (Note 3)	0 to 50 0 to 1.969	0 to 36 0 to 1.417	0 to 30 0 to 1.181	—	—	—	—	—	—	P.65
FD-L31A (Note 3)	4 to 33 0.157 to 1.299	5 to 32 0.197 to 1.260	5 to 30 0.197 to 1.181	4 to 31 0.157 to 1.220	—	—	—	—	—	P.65
FD-L32H (Note 3)	0 to 65 0 to 2.559	15 to 30 0.591 to 1.181	20 to 25 0.787 to 0.984	15 to 30 0.591 to 1.181	—	—	—	—	—	P.66
FD-R31G	240 9.449	42 1.654	30 1.181	41 1.614	9 0.354	6 0.236	21 0.827	5 0.197	2 0.079	P.66
FD-R32EG	90 3.543	15 0.591	10 0.394	10 0.394	2.5 0.098	1.5 0.059	5 0.197	1.3 0.051	—	P.66
FD-R33EG	25 0.984	5 0.197	3 0.118	4 0.157	0.8 0.031	—	2 0.079	—	—	P.66
FD-R34EG	75 2.953	13 0.512	8 0.315	9 0.354	2 0.079	1 0.039	5 0.197	0.9 0.035	—	P.66
FD-R41	330 12.992	65 2.559	47 1.850	51 2.008	10 0.394	1 to 8 0.039 to 0.315	25 0.984	1 to 6 0.039 to 0.236	1 to 5 0.039 to 0.197	P.66
FD-R60	420 16.535	110 4.331	80 3.150	82 3.228	23 0.906	15 0.591	59 2.323	15 0.591	10 0.394	P.66
FD-R61Y	340 13.386	65 2.559	47 1.850	60 2.362	0.5 to 15 0.020 to 0.591	0.5 to 10 0.020 to 0.394	30 1.181	0.5 to 7 0.020 to 0.276	1 to 5 0.039 to 0.197	P.66
FD-S21	80 3.150	18 0.709	13 0.512	12 0.472	2.5 0.098	2 0.079	6.5 0.256	1.5 0.059	1 0.039	P.66
FD-S30	200 7.874	48 0.890	35 1.378	40 1.575	9 0.354	6 0.236	18 0.709	5 0.197	3 0.118	P.67
FD-S31	175 6.890	45 1.772	34 1.339	35 1.378	8 0.315	5 0.197	16 0.630	4 0.157	2 0.079	P.67
FD-S32	510 20.079	120 4.724	90 3.543	105 4.134	27 1.063	18 0.709	65 2.559	16 0.630	11 0.433	P.67
FD-S32W	330 12.992	70 2.756	50 1.969	54 2.126	0.5 to 13 0.020 to 0.512	1 to 8 0.039 to 0.315	29 1.142	1.5 to 7 0.059 to 0.276	1.5 to 4.5 0.059 to 0.177	P.67
FD-S33GW	240 9.449	40 1.575	30 1.181	30 1.181	7 0.276	5 0.197	15 0.591	4 0.157	2 0.079	P.67
FD-S60Y	410 16.142	130 5.118	100 3.937	120 4.724	25 0.984	17 0.669	65 2.559	10 0.394	—	P.67
FD-V30	110 4.331	19 0.748	14 0.551	18 0.709	—	—	10 0.394	—	—	P.67
FD-V30W	30 1.181	5 0.197	3 0.118	—	—	—	—	—	—	P.67
FD-V50	160 6.299	35 1.378	25 0.984	27 1.063	7 0.276	—	16 0.630	—	—	P.68
FD-Z20HBW	1 to 100 0.039 to 3.937	3 to 20 0.118 to 0.787	3 to 15 0.118 to 0.591	3 to 16 0.118 to 0.630	—	—	3 to 8 0.118 to 0.315	—	—	P.68
FD-Z20W	140 5.512	3 to 26 0.118 to 1.024	3 to 17 0.118 to 0.669	4 to 12 0.157 to 0.472	—	—	—	—	—	P.68
FD-Z40HBW	420 16.535	1 to 80 0.039 to 3.150	1 to 60 0.039 to 2.362	1 to 89 0.039 to 3.504	3 to 20 1.181 to 0.787	3 to 13 1.181 to 0.512	1 to 42 0.039 to 1.654	3 to 11 0.118 to 0.433	3 to 7 0.118 to 0.276	P.68
FD-Z40W	340 13.386	1 to 67 0.039 to 2.638	1 to 48 0.039 to 1.890	1 to 55 0.039 to 2.165	5 to 10 0.197-0.394	—	3 to 25 0.118 to 0.984	—	—	P.68
FD-Z50HW	10 to 890 0.394 to 35.039	15 to 210 0.591 to 8.268	15 to 160 0.591 to 6.299	20 to 100 0.787 to 3.937	—	—	20 to 55 0.787 to 2.165	—	—	P.68

Notes: 1) Note that the sensing range of the free-cut type fiber may be reduced by 20 % max. depending upon how the fiber is cut.
 2) The sensing range of reflective type is the value for white non-glossy paper (as for **FD-H30-L32** and **FD-H18-L31** 50 × 50 mm 1.969 × 1.969 in glass substrate).
 3) The sensing range is specified for transparent glass 100 × 100 × 10.7 mm 3.937 × 3.937 × 10.028 in (**FD-L32H**: R edge, **FD-L21** and **FD-L21W**: t2 mm 10.079 in) [**FD-L10**: silicon wafers 100 × 100 mm 3.937 × 3.937 in].
 4) Sold as a set comprising vacuum type fiber + photo-terminal (**FV-BR1**) + fiber at atmospheric side (**FT-J8**).
 5) Liquid inflow prevention joint, protective tube extension joint, fiber mounting joint are available. Please refer to p.38 for details.

FIBER SENSORS

LASER SENSORS

PHOTO-ELECTRIC SENSORS

MICRO PHOTO-ELECTRIC SENSORS

AREA SENSORS

LIGHT CURTAINS / SAFETY COMPONENTS

PRESSURE / FLOW SENSORS

INDUCTIVE PROXIMITY SENSORS

PARTICULAR USE SENSORS

SENSOR OPTIONS

WIRE-SAVING UNITS

WIRE-SAVING SYSTEMS

MEASUREMENT SENSORS

STATIC ELECTRICITY PREVENTION DEVICES

LASER MARKERS

PLC

HUMAN MACHINE INTERFACES

ENERGY CONSUMPTION VISUALIZATION COMPONENTS

FA COMPONENTS

MACHINE VISION SYSTEMS

UV CURING SYSTEMS

Selection Guide

Fibers

Fiber Amplifiers

FX-500

FX-100

FX-300

FX-410



FX-311

FX-301-F7/ FX-301-F

FIBER OPTIONS

Refer to p.69~ for details of lens dimensions.

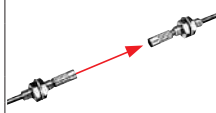
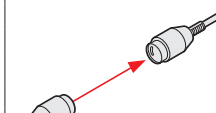
Lens (for thru-beam type fiber)

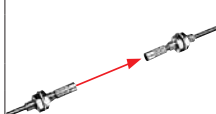
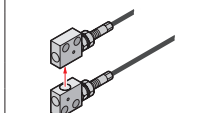
Designation	Model No.	Description							
For thru-beam type fiber	Expansion lens (Note 1)	 <p>Increases the sensing range by 5 times or more.</p> <ul style="list-style-type: none"> Ambient temperature: -60 to +350 °C -76 to +662 °F (Note 5) Beam dia: ø3.6 mm ø0.142 in 	Sensing range for red LED type (mm in) [Lens on both sides] (Note 2)						
			Fiber \ Mode	U-LG	STD	FAST			
			FT-43	3,600 141.732 (Note 3)	2,300 90.551	1,700 66.929			
			FT-42	3,600 141.732 (Note 3)	3,200 125.984	2,300 90.551			
			FT-45X	1,600 62.992 (Note 3)	1,600 62.992 (Note 3)	1,600 62.992 (Note 3)			
			FT-R40	3,600 141.732 (Note 3)	2,900 114.173	2,300 90.551			
	Super-expansion lens (Note 1)	 <p>Tremendously increases the sensing range with large diameter lenses.</p> <ul style="list-style-type: none"> Ambient temperature: -60 to +350 °C -76 to +662 °F (Note 5) Beam dia: ø9.8 mm ø0.386 in 	Sensing range for red LED type (mm in) [Lens on both sides] (Note 2)						
			Fiber \ Mode	U-LG	STD	FAST			
			FT-43	3,600 141.732 (Note 3)	3,600 141.732 (Note 3)	3,600 141.732 (Note 3)			
			FT-42	3,600 141.732 (Note 3)	3,600 141.732 (Note 3)	3,600 141.732 (Note 3)			
			FT-45X	1,600 62.992 (Note 3)	1,600 62.992 (Note 3)	1,600 62.992 (Note 3)			
			FT-R40	3,600 141.732 (Note 3)	3,600 141.732 (Note 3)	3,600 141.732 (Note 3)			
	Side-view lens	 <p>Beam axis is bent by 90°.</p> <ul style="list-style-type: none"> Ambient temperature: -60 to +300 °C -76 to +572 °F (Note 5) Beam dia: ø2.8 mm ø0.110 in 	Sensing range for red LED type (mm in) [Lens on both sides] (Note 2)						
			Fiber \ Mode	U-LG	STD	FAST			
			FT-43	2,300 90.551	480 18.898	350 13.780			
			FT-42	2,400 94.488	450 17.717	330 12.992			
			FT-45X	1,600 62.992 (Note 3)	530 20.866	370 14.567			
			FT-H35-M2	870 34.252	220 8.661	160 6.299			
	Expansion lens for vacuum fiber (Note 1)	 <p>Sensing range increases by 4 times or more.</p> <ul style="list-style-type: none"> Ambient temperature: -60 to +350 °C -76 to +662 °F (Note 5) Beam dia: ø3.6 mm ø0.142 in 	Sensing range for red LED type (mm in) [Lens on both sides] (Note 2, 4)						
			Fiber \ Mode	U-LG	STD	FAST			
			FT-H30-M1V-S	1,600 62.992	450 17.717	300 11.811			
				Vacuum resistant side-view lens (Note 1)	 <p>Beam axis is bent by 90°.</p> <ul style="list-style-type: none"> Ambient temperature: -60 to +300 °C -76 to +572 °F (Note 5) Beam dia: ø3.7 mm ø0.146 in 	Sensing range for red LED type (mm in) [Lens on both sides] (Note 2, 4)			
						Fiber \ Mode	U-LG	STD	FAST
						FT-H30-M1V-S	1,600 62.992	450 17.717	300 11.811

- Notes: 1) Be careful sure to use it only after you have adjusted it sufficiently when installing the thru-beam type fiber equipped with the expansion lens, as the beam envelope becomes narrow and alignment is difficult.
 2) The sensing ranges are the values for red LED type amplifier. Please contact our office for details on sensing ranges for other types of amplifiers.
 3) The fiber cable length practically limits the sensing range.
 4) The fiber cable length for the FT-H30-M1V-S is 1 m 3.281 ft. The sensing ranges in U-LG mode take into account the length of the FT-J8 atmospheric side fiber.
 5) Refer to p.15, p.18, p.33 and p.35 for the ambient temperatures of fibers to be used in combination.

FIBER SENSORS

LASER SENSORS

PHOTO-ELECTRIC SENSORS
MICRO PHOTO-ELECTRIC SENSORS

AREA SENSORS

LIGHT CURTAINS / SAFETY COMPONENTS

PRESSURE / FLOW SENSORS

INDUCTIVE PROXIMITY SENSORS

PARTICULAR USE SENSORS

SENSOR OPTIONS

SIMPLE WIRE-SAVING UNITS

WIRE-SAVING SYSTEMS

MEASUREMENT SENSORS

STATIC ELECTRICITY PREVENTION DEVICES

LASER MARKERS

PLC

HUMAN MACHINE INTERFACES

ENERGY CONSUMPTION VISUALIZATION COMPONENTS

FA COMPONENTS

MACHINE VISION SYSTEMS

UV CURING SYSTEMS

Selection Guide

Fibers

Fiber Amplifiers

FX-500

FX-100

FX-300

FX-410

FX-311

FX-301-F7/
FX-301-F

FIBER OPTIONS

Refer to p.69~ for details of lens dimensions.

Lens (for reflective type fiber)

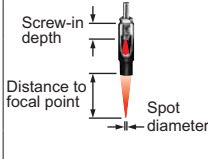
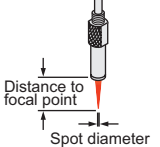
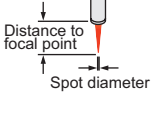
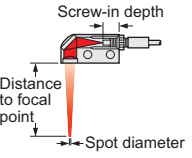
Designation	Model No.	Description													
For reflective type fiber	Pinpoint spot lens	FX-MR1	 <p>Pinpoint spot of $\varnothing 0.5$ mm $\varnothing 0.020$ in. Enables detection of minute objects or small marks.</p> <ul style="list-style-type: none"> Distance to focal point: 6 ± 1 mm 0.236 ± 0.039 in Applicable fibers: FD-42G, FD-42GW Ambient temperature: -40 to $+70$ °C -40 to $+158$ °F (Note 2) 												
	Zoom lens	FX-MR2	 <p>The spot diameter is adjustable from $\varnothing 0.7$ to $\varnothing 2$ mm $\varnothing 0.028$ to $\varnothing 0.079$ in according to how much the fiber is screwed in.</p> <p>Sensing range for red LED type (Note 1)</p> <table border="1"> <thead> <tr> <th>Screw-in depth</th> <th>Distance to focal point</th> <th>Spot diameter</th> </tr> </thead> <tbody> <tr> <td>7 mm 0.276 in</td> <td>$\varnothing 18.5$ mm $\varnothing 0.728$ in approx.</td> <td>$\varnothing 0.7$ mm $\varnothing 0.028$ in</td> </tr> <tr> <td>12 mm 0.472 in</td> <td>$\varnothing 27$ mm $\varnothing 1.063$ in approx.</td> <td>$\varnothing 1.2$ mm $\varnothing 0.047$ in</td> </tr> <tr> <td>14 mm 0.551 in</td> <td>$\varnothing 43$ mm $\varnothing 1.693$ in approx.</td> <td>$\varnothing 2.0$ mm $\varnothing 0.079$ in</td> </tr> </tbody> </table> <ul style="list-style-type: none"> Applicable fibers: FD-42G, FD-42GW Ambient temperature: -40 to $+70$ °C -40 to $+158$ °F (Note 1) Accessory: MS-EX3 (mounting bracket) 	Screw-in depth	Distance to focal point	Spot diameter	7 mm 0.276 in	$\varnothing 18.5$ mm $\varnothing 0.728$ in approx.	$\varnothing 0.7$ mm $\varnothing 0.028$ in	12 mm 0.472 in	$\varnothing 27$ mm $\varnothing 1.063$ in approx.	$\varnothing 1.2$ mm $\varnothing 0.047$ in	14 mm 0.551 in	$\varnothing 43$ mm $\varnothing 1.693$ in approx.	$\varnothing 2.0$ mm $\varnothing 0.079$ in
	Screw-in depth	Distance to focal point	Spot diameter												
	7 mm 0.276 in	$\varnothing 18.5$ mm $\varnothing 0.728$ in approx.	$\varnothing 0.7$ mm $\varnothing 0.028$ in												
	12 mm 0.472 in	$\varnothing 27$ mm $\varnothing 1.063$ in approx.	$\varnothing 1.2$ mm $\varnothing 0.047$ in												
14 mm 0.551 in	$\varnothing 43$ mm $\varnothing 1.693$ in approx.	$\varnothing 2.0$ mm $\varnothing 0.079$ in													
Finest spot lens	FX-MR3	 <p>Extremely fine spot of $\varnothing 0.15$ mm $\varnothing 0.006$ in approx. achieved.</p> <ul style="list-style-type: none"> Applicable fibers: FD-EG31, FD-EG30, FD-42G, FD-42GW, FD-32G, FD-32GX Ambient temperature: -40 to $+70$ °C -40 to $+158$ °F (Note 2) <p>Sensing range for red LED type (Note 1)</p> <table border="1"> <thead> <tr> <th>Fiber</th> <th>Distance to focal point</th> <th>Spot diameter</th> </tr> </thead> <tbody> <tr> <td>FD-EG31</td> <td>7.5 ± 0.5 mm 0.295 ± 0.020 in</td> <td>$\varnothing 0.15$ mm $\varnothing 0.006$ in approx.</td> </tr> <tr> <td>FD-EG30</td> <td>7.5 ± 0.5 mm 0.295 ± 0.020 in</td> <td>$\varnothing 0.3$ mm $\varnothing 0.012$ in approx.</td> </tr> <tr> <td>FD-42G/42GW FD-32G/32GX</td> <td>7.5 ± 0.5 mm 0.295 ± 0.020 in</td> <td>$\varnothing 0.5$ mm $\varnothing 0.020$ in approx.</td> </tr> </tbody> </table>	Fiber	Distance to focal point	Spot diameter	FD-EG31	7.5 ± 0.5 mm 0.295 ± 0.020 in	$\varnothing 0.15$ mm $\varnothing 0.006$ in approx.	FD-EG30	7.5 ± 0.5 mm 0.295 ± 0.020 in	$\varnothing 0.3$ mm $\varnothing 0.012$ in approx.	FD-42G/42GW FD-32G/32GX	7.5 ± 0.5 mm 0.295 ± 0.020 in	$\varnothing 0.5$ mm $\varnothing 0.020$ in approx.	
Fiber	Distance to focal point	Spot diameter													
FD-EG31	7.5 ± 0.5 mm 0.295 ± 0.020 in	$\varnothing 0.15$ mm $\varnothing 0.006$ in approx.													
FD-EG30	7.5 ± 0.5 mm 0.295 ± 0.020 in	$\varnothing 0.3$ mm $\varnothing 0.012$ in approx.													
FD-42G/42GW FD-32G/32GX	7.5 ± 0.5 mm 0.295 ± 0.020 in	$\varnothing 0.5$ mm $\varnothing 0.020$ in approx.													
Finest spot lens	FX-MR6	 <p>Extremely fine spot of $\varnothing 0.1$ mm $\varnothing 0.004$ in approx. achieved.</p> <ul style="list-style-type: none"> Applicable fibers: FD-EG31, FD-EG30, FD-42G, FD-42GW, FD-32G, FD-32GX Ambient temperature: -20 to $+60$ °C -4 to $+140$ °F (Note 2) <p>Sensing range for red LED type (Note 1)</p> <table border="1"> <thead> <tr> <th>Fiber</th> <th>Distance to focal point</th> <th>Spot diameter</th> </tr> </thead> <tbody> <tr> <td>FD-EG31</td> <td>7 ± 0.5 mm 0.276 ± 0.020 in</td> <td>$\varnothing 0.1$ mm $\varnothing 0.004$ in approx.</td> </tr> <tr> <td>FD-EG30</td> <td>7 ± 0.5 mm 0.276 ± 0.020 in</td> <td>$\varnothing 0.2$ mm $\varnothing 0.008$ in approx.</td> </tr> <tr> <td>FD-42G/42GW FD-32G/32GX</td> <td>7 ± 0.5 mm 0.276 ± 0.020 in</td> <td>$\varnothing 0.4$ mm $\varnothing 0.016$ in approx.</td> </tr> </tbody> </table>	Fiber	Distance to focal point	Spot diameter	FD-EG31	7 ± 0.5 mm 0.276 ± 0.020 in	$\varnothing 0.1$ mm $\varnothing 0.004$ in approx.	FD-EG30	7 ± 0.5 mm 0.276 ± 0.020 in	$\varnothing 0.2$ mm $\varnothing 0.008$ in approx.	FD-42G/42GW FD-32G/32GX	7 ± 0.5 mm 0.276 ± 0.020 in	$\varnothing 0.4$ mm $\varnothing 0.016$ in approx.	
Fiber	Distance to focal point	Spot diameter													
FD-EG31	7 ± 0.5 mm 0.276 ± 0.020 in	$\varnothing 0.1$ mm $\varnothing 0.004$ in approx.													
FD-EG30	7 ± 0.5 mm 0.276 ± 0.020 in	$\varnothing 0.2$ mm $\varnothing 0.008$ in approx.													
FD-42G/42GW FD-32G/32GX	7 ± 0.5 mm 0.276 ± 0.020 in	$\varnothing 0.4$ mm $\varnothing 0.016$ in approx.													
Zoom lens (Side-view type)	FX-MR5	 <p>FX-MR2 is converted into a side-view type and can be mounted in a very small space.</p> <ul style="list-style-type: none"> Applicable fibers: FD-42G, FD-42GW Ambient temperature: -40 to $+70$ °C -40 to $+158$ °F (Note 2) <p>Sensing range for red LED type (Note 1)</p> <table border="1"> <thead> <tr> <th>Screw-in depth</th> <th>Distance to focal point</th> <th>Spot diameter</th> </tr> </thead> <tbody> <tr> <td>8 mm 0.315 in</td> <td>13 mm 0.512 in approx.</td> <td>$\varnothing 0.5$ mm $\varnothing 0.020$ in</td> </tr> <tr> <td>10 mm 0.394 in</td> <td>15 mm 0.591 in approx.</td> <td>$\varnothing 0.8$ mm $\varnothing 0.031$ in</td> </tr> <tr> <td>14 mm 0.551 in</td> <td>30 mm 1.181 in approx.</td> <td>$\varnothing 3.0$ mm $\varnothing 0.118$ in</td> </tr> </tbody> </table>	Screw-in depth	Distance to focal point	Spot diameter	8 mm 0.315 in	13 mm 0.512 in approx.	$\varnothing 0.5$ mm $\varnothing 0.020$ in	10 mm 0.394 in	15 mm 0.591 in approx.	$\varnothing 0.8$ mm $\varnothing 0.031$ in	14 mm 0.551 in	30 mm 1.181 in approx.	$\varnothing 3.0$ mm $\varnothing 0.118$ in	
Screw-in depth	Distance to focal point	Spot diameter													
8 mm 0.315 in	13 mm 0.512 in approx.	$\varnothing 0.5$ mm $\varnothing 0.020$ in													
10 mm 0.394 in	15 mm 0.591 in approx.	$\varnothing 0.8$ mm $\varnothing 0.031$ in													
14 mm 0.551 in	30 mm 1.181 in approx.	$\varnothing 3.0$ mm $\varnothing 0.118$ in													

Notes: 1) The sensing ranges are the values when used in combination with red LED type amplifier. Please contact our office for details on sensing ranges for other types of amplifier.
 2) Refer to p.16 or p.26 for the ambient temperatures of fibers to be used in combination.

FIBER SENSORS

LASER SENSORS

PHOTO-ELECTRIC SENSORS

MICRO PHOTO-ELECTRIC SENSORS

AREA SENSORS

LIGHT CURTAINS / SAFETY COMPONENTS

PRESSURE / FLOW SENSORS

INDUCTIVE PROXIMITY SENSORS

PARTICULAR USE SENSORS

SENSOR OPTIONS

SIMPLE WIRE-SAVING UNITS

WIRE-SAVING SYSTEMS

MEASURE-MENT SENSORS

STATIC ELECTRICITY PREVENTION DEVICES

LASER MARKERS

PLC

HUMAN MACHINE INTERFACES

ENERGY CONSUMPTION VISUALIZATION COMPONENTS

FA COMPONENTS

MACHINE VISION SYSTEMS

UV CURING SYSTEMS

Selection Guide

Fibers

Fiber Amplifiers

FX-500

FX-100

FX-300

FX-410

FX-311

FX-301-F7/
FX-301-F

FIBER OPTIONS

Refer to p.69~ for details of lens dimensions.

Lens (For square head M3 reflective fiber)

Type	Spot diameter (mm in) (Note)	Distance to focal point (mm in) (Note)	Lens		Fiber			
			Shape (mm in)	Model No.	Shape	Emitting fiber core (mm in)	Model No.	
For Square head M3 reflective fiber	∅0.1 ∅0.004 approx.	7 ±0.5 0.276 ±0.020	∅5 ∅0.197		FX-MR7		∅0.125 ∅0.005	FD-R33EG
	∅0.15 ∅0.006 approx.						∅0.125 ∅0.005	FD-EG31
	∅0.2 ∅0.008 approx.						∅0.175 ∅0.007	FD-R34EG
	∅0.25 ∅0.010 approx.						∅0.25 ∅0.010	FD-R32EG
Finest spot lens	∅0.4 ∅0.016 approx.	7 ±0.5 0.276 ±0.020	∅5 ∅0.197		FX-MR7		∅0.25 ∅0.010	FD-EG30
							∅0.5 ∅0.020	FD-R31G
							∅0.5 ∅0.020	FD-32G
							∅0.5 ∅0.020	FD-32GX
	∅0.5 ∅0.020	FD-42G						
	∅0.5 ∅0.020	FD-42GW						

Type	Spot diameter (mm in) (Note)	Sensing range (mm in) (Note)	Lens		Applicable fibers		
			Shape (mm in)	Model No.	Emitting fiber core (mm in)	Model No.	
For Square head M3 reflective fiber	∅0.4 to ∅2.0 ∅0.016 to ∅0.079 approx.	10 to 30 0.394 to 1.181	∅5 ∅0.197		FX-MR8	∅0.125 ∅0.005	FD-R33EG, FD-EG31
						∅0.175 ∅0.007	FD-R34EG
						∅0.25 ∅0.010	FD-R32EG, FD-EG30
						∅0.5 ∅0.020	FD-R31G, FD-32G, FD-32GX, FD-42G, FD-42GW
Parallel light lens	∅4.0 ∅0.157 approx.	0 to 30 0 to 1.181	∅5 ∅0.197		FX-MR9	∅0.125 ∅0.005	FD-R33EG, FD-EG31
						∅0.175 ∅0.007	FD-R34EG
						∅0.25 ∅0.010	FD-R32EG, FD-EG30
						∅0.5 ∅0.020	FD-R31G, FD-32G, FD-32GX, FD-42G, FD-42GW

Note: Spot diameter, distance to focal point and sensing range are specified for a red LED type amplifier.

Others

Designation	Model No.	Description				
Protective tube (For thru-beam type fiber)	FTP-500 (0.5m 1.641 ft)	For M4 thread	FT-42 FT-42S FT-42W	FT-43 FT-H13-FM2	The protective tube, made of noncorrosive stainless steel, protects the inner fiber cable from any external forces.	
	FTP-1000 (1m 3.281 ft)		For M3 thread	FT-31 FT-31S FT-31W		FD-31 FD-31W
	FTP-1500 (1.5m 4.922 ft)			For M6 thread		FD-61 FD-61G FD-61S
	FDP-500 (0.5m 1.641 ft)	For M4 thread				FD-41 FD-41W
	FDP-1000 (1m 3.281 ft)					
	FDP-1500 (1.5m 4.922 ft)					
Protective tube (For reflective type fiber)	FDP-500 (0.5m 1.641 ft)					
Fiber bender	FB-1	The fiber bender bends the sleeve part of the fiber head at the proper radius. (Note 1)				
	Universal sensor mounting stand (Note 2)	MS-AJ1-F	Horizontal mounting type	Mounting stand assembly for fiber (For M3, M4 or M6 threaded head fiber)		
		MS-AJ2-F	Vertical mounting type			
	Single-core holder	FX-AT15A	The incident light intensity may vary when using a multi-core fiber or a thin type sharp bending fiber. This holder suppresses the variation in the incident light intensity. Brown.			

Notes: 1) Do not bend the sleeve part of any side-view type fiber or ultra-small diameter head type fiber.
2) Refer to the universal sensor mounting stand MS-AJ series pages for details.

Protective tube

- FTP-□
- FDP-□

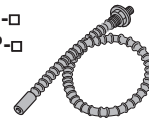

Fiber bender

- FB-1

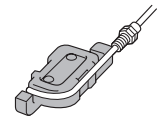

Universal sensor mounting stand

Using the arm which enables adjustment in the horizontal direction, sensing can also be done from above an assembly line.

- MS-AJ1-F Swivel: 360° rotation

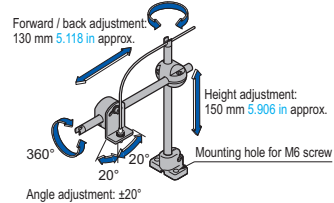

- MS-AJ2-F Swivel: 360° rotation

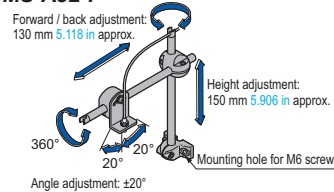

Single-core holder

- FX-AT15A



SPECIFICATIONS

Item	Model No.	NPN output			PNP output		
		Red LED	Blue LED	Green LED	Red LED	Blue LED	Green LED
		FX-411	FX-411B	FX-411G	FX-411P	FX-411BP	FX-411GP
Supply voltage		12 to 24 V DC $\pm 10\%$ Ripple P-P 10% or less					
Power consumption		<p><Red LED type> Normal operation: 960 mW or less (Current consumption 40 mA or less at 24 V supply voltage) ECO mode: 840 mW or less (Current consumption 35 mA or less at 24 V supply voltage)</p> <p><Blue LED / Green LED type> Normal operation: 720 mW or less (Current consumption 30 mA or less at 24 V supply voltage) ECO mode: 580 mW or less (Current consumption 24 mA or less at 24 V supply voltage)</p>					
Output		<p><NPN output type> NPN open-collector transistor • Maximum sink current: 100 mA (50 mA, if five, or more, amplifiers are connected in cascade) • Applied voltage: 30 V DC or less (between output and 0 V) • Residual voltage: 1.5 V or less [at 100 mA sink current (50 mA, if five, or more, amplifiers are connected in cascade)]</p>			<p><PNP output type> PNP open-collector transistor • Maximum source current: 100 mA (50 mA, if five, or more, amplifiers are connected in cascade) • Applied voltage: 30 V DC or less (between output and +V) • Residual voltage: 1.5 V or less [at 100 mA sink current (50 mA, if five, or more, amplifiers are connected in cascade)]</p>		
Utilization category		DC-12 or DC-13					
Output operation		Switchable either Light-ON or Dark-ON					
Short-circuit protection		Incorporated					
Response time		150 μ s or less (FAST), 500 μ s or less (STD), 4.5 ms or less (U-LG) selectable with setting switch					
Operation indicator		Orange LED (lights up when the output is ON)					
Stability indicator		Green LED (lights up under stable light received condition or stable dark condition)					
Timer function		Incorporated with variable ON-delay / OFF-delay / ONE SHOT timer, switchable either effective or ineffective. [Timer period (Note 3): 1 ms to 3 sec. approx. (1 to 10 ms: Setting possible in units of 1 ms, 10 to 100 ms: Setting possible in units of 10 ms, 100 to 500 ms: Setting possible in units of 50 ms, 500 ms to 1 sec.: Setting possible in units of 100 ms, 1 to 3 sec.: Setting possible in units of 500 ms)]					
Automatic interference prevention function		Incorporated (Up to four sets of fiber heads can be mounted close together. However, U-LG mode is 8 fiber heads.)(Note 4)					
Environmental resistance	Pollution degree	3 (Industrial environment)					
	Ambient temperature	-10 to +55 °C -14 to +131 °F (If 4 to 7 units are connected in cascade: -10 to +50 °C +14 to +122 °F , if 8 to 16 units are connected in cascade: -10 to +45 °C +14 to +113 °F) (No dew condensation or icing allowed), Storage: -20 to +70 °C -4 to +158 °F					
	Ambient humidity	35 to 85 % RH, Storage: 35 to 85 % RH					
	Ambient illuminance	Incandescent light: 3,000 lx or less at the light-receiving face					
	EMC	EN 60947-5-2					
	Voltage withstandability	1,000 V AC for one min. between all supply terminals connected together and enclosure (Note 5)					
	Insulation resistance	20 M Ω , or more, with 250 V DC megger between all supply terminals connected together and enclosure (Note 5)					
	Vibration resistance	10 to 150 Hz frequency, 0.75 mm 0.030 in amplitude in X, Y and Z directions for two hours each					
Shock resistance	98 m/s ² acceleration (10 G approx.) in X, Y and Z directions for five times each						
Emitting element (modulated)		Red LED	Blue LED	Green LED	Red LED	Blue LED	Green LED
Peak emission wavelength		650 nm 0.026 mil	470 nm 0.019 mil	525 nm 0.021 mil	650 nm 0.026 mil	470 nm 0.019 mil	525 nm 0.021 mil
Material		Enclosure: Heat-resistant ABS, Case cover: Polycarbonate					
Cable length		Total length up to 100 m 328.084 ft (50 m 164.042 ft for 5 to 8 units, 20 m 65.617 ft for 9 to 16 units) is possible with 0.3 mm ² , or more, cable.					
Weight		Net weight: 20 g approx., Gross weight: 30 g approx.					

Notes: 1) Where measurement conditions have not been specified precisely, the conditions used were an ambient temperature of +23 °C **+73.4 °F**.

2) The **FX-412** has a threshold value adjuster that can be adjusted with your fingers.

3) For models manufactured up until June 2005, the timer period is approx. 1 to 500 ms.

4) When the power supply is switched on, the light emission timing is automatically set for interference prevention.

5) The voltage withstandability and the insulation resistance values given in the above table are for the amplifier only.

FIBER SENSORS

LASER SENSORS

PHOTO-ELECTRIC SENSORS

MICRO PHOTO-ELECTRIC SENSORS

AREA SENSORS

LIGHT CURTAINS / SAFETY COMPONENTS

PRESSURE / FLOW SENSORS

INDUCTIVE PROXIMITY SENSORS

PARTICULAR USE SENSORS

SENSOR OPTIONS

SIMPLE WIRE-SAVING UNITS

WIRE-SAVING SYSTEMS

MEASUREMENT SENSORS

STATIC ELECTRICITY PREVENTION DEVICES

LASER MARKERS

PLC

HUMAN MACHINE INTERFACES

ENERGY CONSUMPTION VISUALIZATION COMPONENTS

FA COMPONENTS

MACHINE VISION SYSTEMS

UV CURING SYSTEMS

Selection Guide

Fibers

Fiber Amplifiers

FX-500**FX-100****FX-300****FX-410****FX-311****FX-301-F7/****FX-301-F**

I/O CIRCUIT DIAGRAMS

FX-410 NPN output type

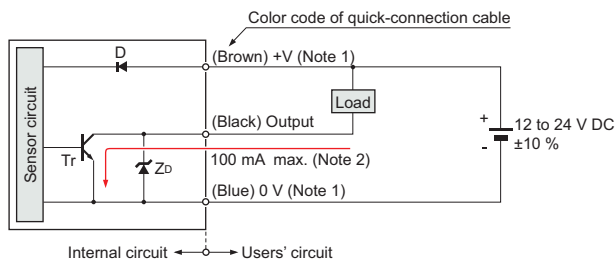

Notes: 1) The quick-connection sub cable does not have +V (brown) and 0 V (blue). The power is supplied from the connector of the main cable.
2) 50 mA max., if five amplifiers, or more, are connected together.

Symbols ... D : Reverse supply polarity protection diode
Zd: Surge absorption zener diode
Tr : NPN output transistor

FX-410P PNP output type

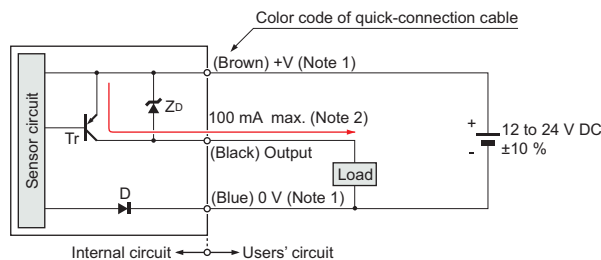

Notes: 1) The quick-connection sub cable does not have +V (brown) and 0 V (blue). The power is supplied from the connector of the main cable.
2) 50 mA max., if five amplifiers, or more, are connected together.

Symbols ... D : Reverse supply polarity protection diode
Zd: Surge absorption zener diode
Tr : PNP output transistor

PRECAUTIONS FOR PROPER USE

Refer to p.1458~ for general precautions.



- Never use this product as a sensing device for personnel protection.
- In case of using sensing devices for personnel protection, use products which meet laws and standards, such as OSHA, ANSI or IEC etc., for personnel protection applicable in each region or country.

Part description

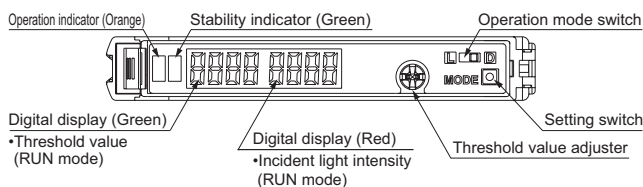

Wiring

- Make sure that the power supply is off while wiring.
- Verify that the supply voltage variation is within the rating.
- Take care that if a voltage exceeding the rated range is applied, or if an AC power supply is directly connected, the product may get burnt or damaged.
- In case noise generating equipment (switching regulator, inverter motor, etc.) is used in the vicinity of this product, connect the frame ground (F.G.) terminal of the equipment to an actual ground.
- If power is supplied from a commercial switching regulator, ensure that the frame ground (F.G.) terminal of the power supply is connected to an actual ground.
- Take care that short circuit of the load wrong wiring may burn or damage the product.
- Do not run the wires together with high-voltage lines or power lines or put them in the same raceway. This can cause malfunction due to induction.
- Extension up to total 100 m **328.084 ft** (if 5 to 8 units are connected in cascade: 50 m **164.042 ft**, if 9 to 16 units are connected in cascade: 20 m **65.617 ft**) is possible with 0.3 mm², or more, cable. However, in order to reduce noise, make the wiring as short as possible.
- Take care that cable extension increases the residual voltage.

Mounting

- Make sure that the power supply is off while connecting / disconnecting the amplifiers and the quick-connection cables.

How to mount the amplifier

- ① Fit the rear part of the mounting section of the amplifier on a width DIN rail.
- ② Press down the rear part of the mounting section of the unit on the width DIN rail and fit the front part of the mounting section to the DIN rail.

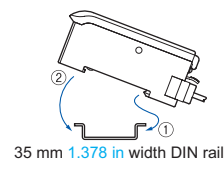

How to remove the amplifier

- ① Push the amplifier forward.
- ② Lift up the front part of the amplifier to remove it.

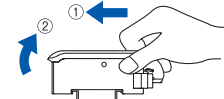

Note: Take care that if the front part is lifted without pushing the amplifier forward, the hook on the rear portion of the mounting section is likely to break.

Fiber installation

- Insert the fiber into the amplifier after attaching the attachment. Refer to the "Instruction Manual" included with the fiber for details.

- ① Push the fiber lock lever down.
- ② Slowly insert the fiber into the insertion slot until it stops. (Note 1)
- ③ Push the fiber lock lever back up until it stops.

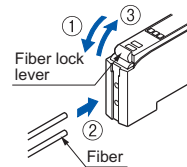

Notes: 1) Note that if the fiber is not fully inserted, the sensing distance will decrease. Also note that the flexible fiber may bend during insertion.
2) In case of coaxial reflective type fibers, mount the central fiber (single-core) to the emitter part and the peripheral fiber (multi-core) to the receiver. Note that sensing precision will deteriorate when done in reverse.

PRECAUTIONS FOR PROPER USE

Refer to p.1458~ for general precautions.

Cascading

- Make sure that the power supply is off while adding or removing the amplifiers.
- Make sure to check the allowable ambient temperature, as it depends on the number of amplifiers connected in cascade.
- In case two, or more, amplifiers are connected in cascade, make sure to mount them on a DIN rail.
- When the amplifiers move on the DIN rail depending on the attaching condition or the amplifiers are mounted close to each other in cascade, fit them between the optional end plates (**MS-DIN-E**) mounted at the two ends.
- Up to maximum 15 amplifiers can be added (total 16 amplifiers connected in cascade.)
- When connecting more than two amplifiers in cascade, use the sub cable (**CN-71-C**) as the quick-connection cable for the second amplifier onwards.
- When connecting amplifiers not close to each other in parallel, be sure to mount the optional end plate (**MS-DIN-E**) at both sides of each amplifier or affix the communication window seal of the optional fiber amplifier protection seal (**FX-MB1**) to the communication windows. For details, refer to the instruction manual enclosed with the **FX-MB1**.
- When the different LED (red / blue / green) types are connected in cascade, mount the identical models together.
- When this product is used with the other digital fiber amplifiers, be sure to place this product to the left most position (When you look from the connector side). If this product is not placed to the leftmost position, this product may not operate properly.

Cascading method

- ① Mount the amplifiers, one by one, on the DIN rail.
- ② Slide the amplifiers next to each other, and connect the quick-connection cables.
- ③ Mount the optional end plates (**MS-DIN-E**) at both the ends to hold the amplifiers between their flat sides.
- ④ Tighten the screws to fix the end plates.

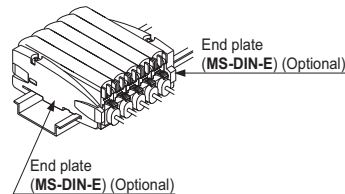
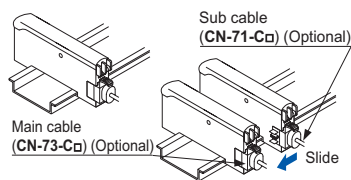

Dismantling

- ① Loosen the screws of the end plates.
- ② Remove the end plates.
- ③ Slide the amplifiers and remove them one by one.

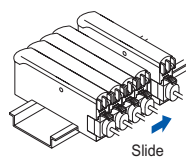

Switching output operation

- The operation selection switch can be used to display different output operations (L-ON / D-ON) on the digital display.

When set to Dark-ON (D-ON)



When set to Light-ON (L-ON)



Threshold value (sensitivity) adjustment

- ① Check the incident light intensity [in the digital display (red)] when a sensing object is placed in the sensing position.
- ② Check the incident light intensity [in the digital display (red)] when the sensing object is removed from the sensing position.
- ③ Turn the threshold value adjuster to the threshold value [in the digital display (green)] that is the value in between ① and ②. (The threshold value is automatically written to the EEPROM.)

Threshold value setting method

- When the threshold value adjuster is turned clockwise, the threshold value increases. When the threshold value adjuster is turned counterclockwise, the threshold value decreases.



- If there is a sufficient level of margin in the incident light intensity, the stability indicator (green) will light up.

Mode selection

- When the setting switch is pressed and held for 2 sec. or more, "SET" mode (mode setting screen) is activated.
- If the setting switch is pressed while in "SET" mode, the mode will change.
- If the threshold value adjuster is turned while a mode is active, the setting item will change and blink.
- When the setting switch is pressed at the item you would like to set, it blinks 3 times and then the setting is confirmed and the mode switches to the next mode.
- If the setting switch is pressed and held for 2 sec. or more or do not press any key for 15 sec. while "SET" mode is active, the mode will switch automatically to "RUN" mode.

FIBER SENSORS

LASER SENSORS

PHOTO-ELECTRIC SENSORS

MICRO PHOTO-ELECTRIC SENSORS

AREA SENSORS

LIGHT CURTAINS / SAFETY COMPONENTS

PRESSURE / FLOW SENSORS

INDUCTIVE PROXIMITY SENSORS

PARTICULAR USE SENSORS

SENSOR OPTIONS

SIMPLE WIRE-SAVING UNITS

WIRE-SAVING SYSTEMS

MEASUREMENT SENSORS

STATIC ELECTRICITY PREVENTION DEVICES

LASER MARKERS

PLC

HUMAN MACHINE INTERFACES

ENERGY CONSUMPTION VISUALIZATION COMPONENTS

FA COMPONENTS

MACHINE VISION SYSTEMS

UV CURING SYSTEMS

Selection Guide

Fibers

Fiber Amplifiers

FX-500

FX-100

FX-300

FX-410

FX-311

FX-301-F7/

FX-301-F

PRECAUTIONS FOR PROPER USE

Refer to p.1458~ for general precautions.

Mode table

Mode	Factory setting	Description
Response time change mode	SPEd 5td	The response time can be set.
Light-emitting amount selection mode (Note 1)	PEtL 0000	The light-emitting amount can be switched among four levels.
Timer setting mode	dELy non	Timer settings can be selected; Without timer / OFF-delay timer / ON-delay timer / ONE SHOT timer. Also the timer period can be set.
Digital display inversion mode	EWn 0ff	The display on the digital display can be inverted.
Eco mode (Note 2)	Eco 0ff	If no key is pressed for 20 sec. approx. while in "RUN" mode, the digital display turns off automatically. Press the setting switch or move the operation mode switch to make the display light up again. The digital display will light up when the threshold value adjuster is turned, but note that this will also cause the threshold value to change.
Peak / Bottom hold mode	Hold 0ff	If the setting switch is pressed while "RUN" mode is active, the display will alternate between the peak hold value and the bottom hold value. (The display will refresh every 2 sec.) The display will return to normal if any operation other than threshold value setting is carried out.

Notes: 1) This mode is not incorporated in the blue LED type and green LED type.
2) While the peak / bottom hold mode is ON, the digital display is not turned off even if the Eco mode is set to ON.

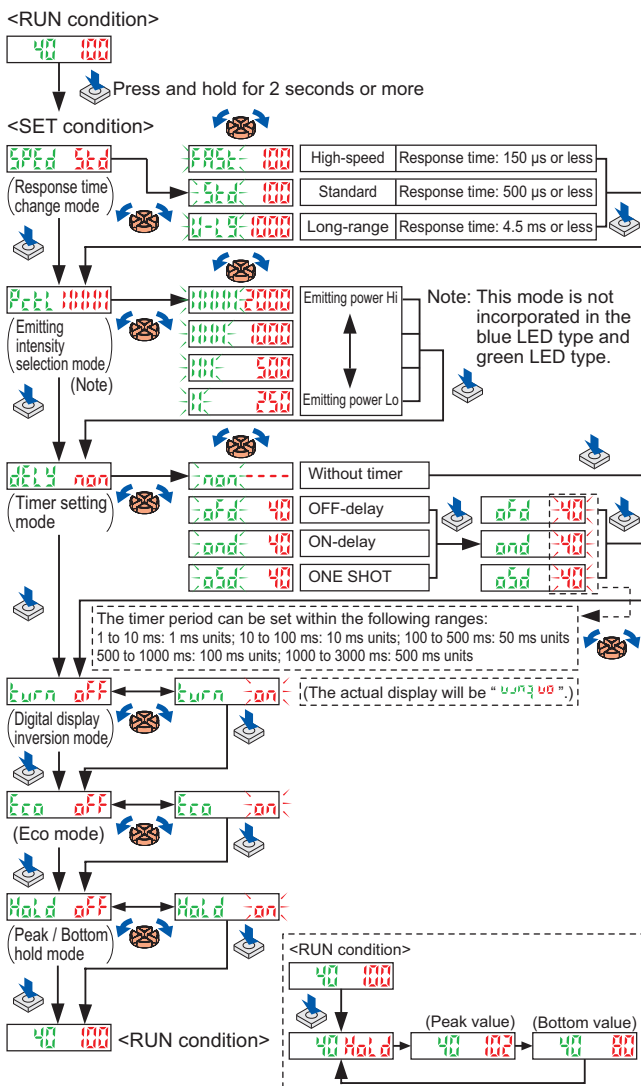

Key lock function

- When the setting switch is pressed and held for 5 sec. while in 'RUN' mode, the key lock function can be set / canceled.
- When the key lock function is set to ON, even if the threshold value adjuster or the setting switch is operated, "Loc" is displayed and the key operation cannot be carried out.

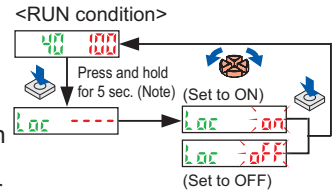

Note: Although the display changes to the indication of 'SET' condition 2 sec. after pressing the setting switch, keep pressing the switch. Furthermore, the sensor does not go into the key lock setting from 'SET' condition.

Factory setting

- When the setting switch is pressed and held for 10 sec., until "-----" is displayed while in 'RUN' mode, the all settings are returned to the factory setting. (For the factory setting, refer to 'Mode table' in 'Mode selection'.)

Error display indicator readings

Display	Error description	Measures
Er-1	The load has short-circuited and excess current is flowing.	Turn off the power, then check the load.
Er-5	Communication error has occurred at time of connection.	Check if the mounted amplifiers are in close contact with each other.

Others

- Do not use during the initial transient time (0.5 sec.) after the power supply is switched on.
- This sensor is suitable for indoor use only.
- Do not use this sensor in places having excessive vapor, dust, etc., or where it may come in contact with corrosive gas.
- Take care that the sensor does not come in direct contact with oil, grease, organic solvents, such as, thinner etc., or strong acid, and alkaline.
- This sensor cannot be used in an environment containing inflammable or explosive gases.
- Never disassemble or modify the sensor.
- The changes to the settings are written to the EEPROM, but because the EEPROM has a limited service life, you should avoid changing the settings any more than 1 million times.

FIBER SENSORS
LASER SENSORS
PHOTO-ELECTRIC SENSORS
MICRO PHOTO-ELECTRIC SENSORS
AREA SENSORS
LIGHT CURTAINS / SAFETY COMPONENTS
PRESSURE / FLOW SENSORS
INDUCTIVE PROXIMITY SENSORS
PARTICULAR USE SENSORS
SENSOR OPTIONS
SIMPLE WIRE-SAVING UNITS
WIRE-SAVING SYSTEMS
MEASUREMENT SENSORS
STATIC ELECTRICITY PREVENTION DEVICES
LASER MARKERS
PLC
HUMAN MACHINE INTERFACES
ENERGY CONSUMPTION VISUALIZATION COMPONENTS
FA COMPONENTS
MACHINE VISION SYSTEMS
UV CURING SYSTEMS
Selection Guide
Fibers
Fiber Amplifiers
FX-500
FX-100
FX-300
FX-410
FX-311
FX-301-F7/
FX-301-F

DIMENSIONS (Unit: mm in)

The CAD data in the dimensions can be downloaded from our website.

FX-411□ FX-411□P Amplifier

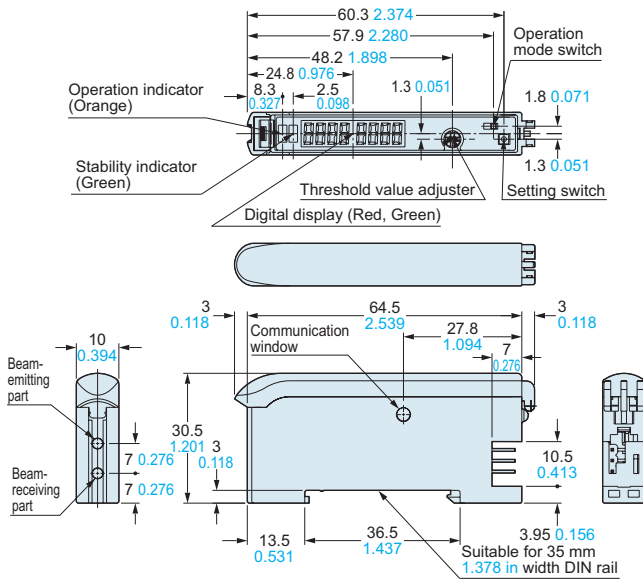

FX-412□ Amplifier

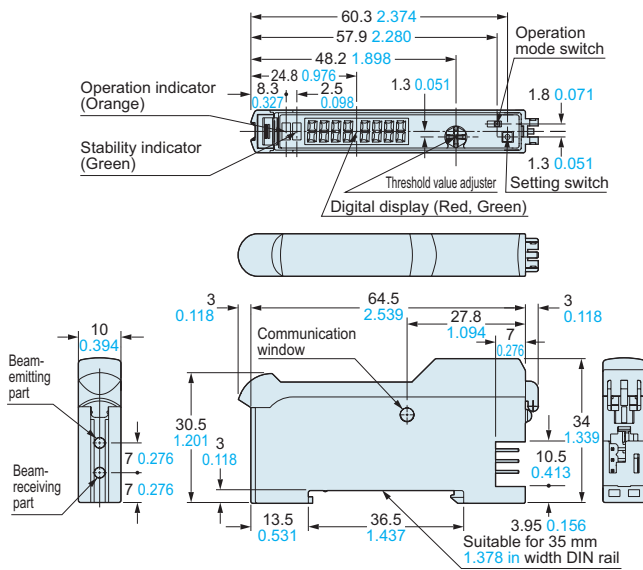

CN-71-C1 CN-71-C2 CN-71-C5 Sub cable (Optional)

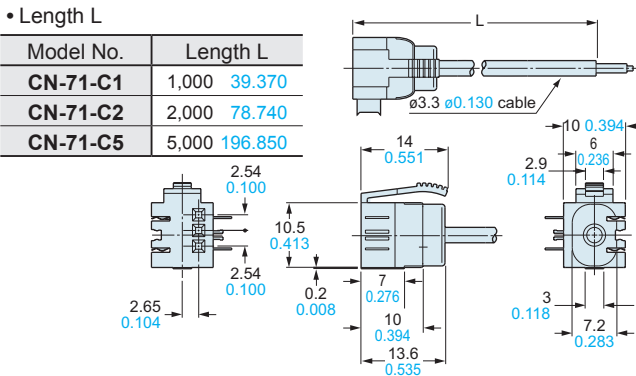

CN-73-C1 CN-73-C2 CN-73-C5 Main cable (Optional)

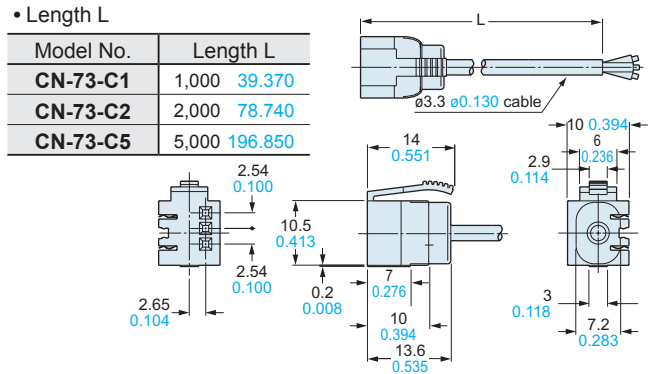

MS-DIN-E End plate (Optional)

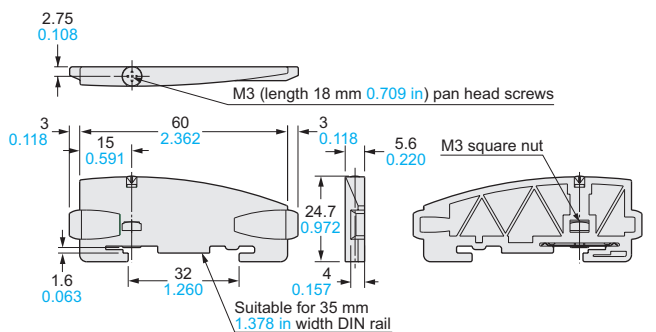

Material: Polycarbonate

MS-DIN-2 Amplifier mounting bracket (Optional)

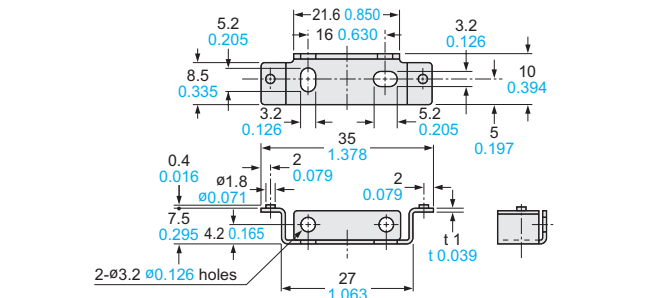

Material: Cold rolled carbon steel (SPCC) (Uni-chrome plated)

FIBER SENSORS

LASER SENSORS

PHOTO-ELECTRIC SENSORS

MICRO PHOTO-ELECTRIC SENSORS

AREA SENSORS

LIGHT CURTAINS / SAFETY COMPONENTS

PRESSURE / FLOW SENSORS

INDUCTIVE PROXIMITY SENSORS

PARTICULAR USE SENSORS

SENSOR OPTIONS

SMALL WIRE-SAVING UNITS

WIRE-SAVING SYSTEMS

MEASUREMENT SENSORS

STATIC ELECTRICITY PREVENTION DEVICES

LASER MARKERS

PLC

HUMAN MACHINE INTERFACES

ENERGY CONSUMPTION VISUALIZATION COMPONENTS

FA COMPONENTS

MACHINE VISION SYSTEMS

UV CURING SYSTEMS

Selection Guide

Fibers

Fiber Amplifiers

FX-500

FX-100

FX-300

FX-410

FX-311

FX-301-F7/

FX-301-F