



Chipsmall Limited consists of a professional team with an average of over 10 year of expertise in the distribution of electronic components. Based in Hongkong, we have already established firm and mutual-benefit business relationships with customers from,Europe,America and south Asia,supplying obsolete and hard-to-find components to meet their specific needs.

With the principle of “Quality Parts,Customers Priority,Honest Operation,and Considerate Service”,our business mainly focus on the distribution of electronic components. Line cards we deal with include Microchip,ALPS,ROHM,Xilinx,Pulse,ON,Everlight and Freescale. Main products comprise IC,Modules,Potentiometer,IC Socket,Relay,Connector.Our parts cover such applications as commercial,industrial, and automotives areas.

We are looking forward to setting up business relationship with you and hope to provide you with the best service and solution. Let us make a better world for our industry!



Contact us

Tel: +86-755-8981 8866 Fax: +86-755-8427 6832

Email & Skype: info@chipsmall.com Web: www.chipsmall.com

Address: A1208, Overseas Decoration Building, #122 Zhenhua RD., Futian, Shenzhen, China



COUNT	DESCRIPTION OF REVISIONS	BY	CHKD	DATE	COUNT	DESCRIPTION OF REVISIONS	BY	CHKD	DATE
△				..	△				..
△				..	△				..
△				..	△				..

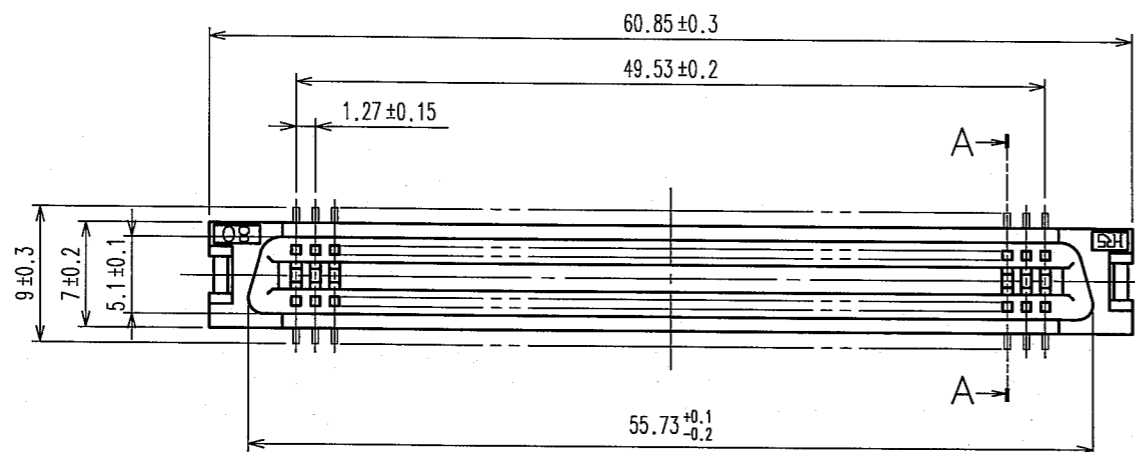

RECOMMENDED LAND PATTERN DIMENSION OF PCB (MOUNTING SIDE)

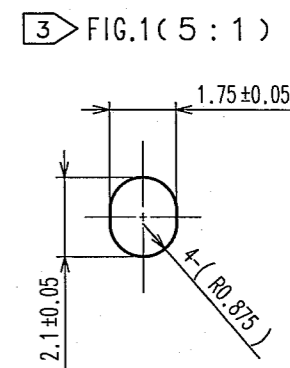
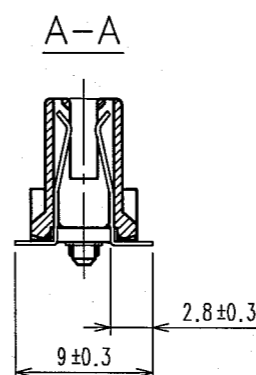
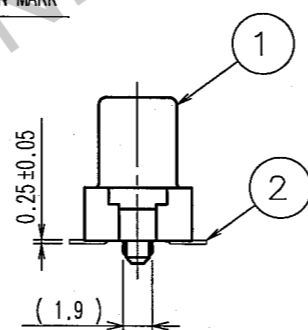
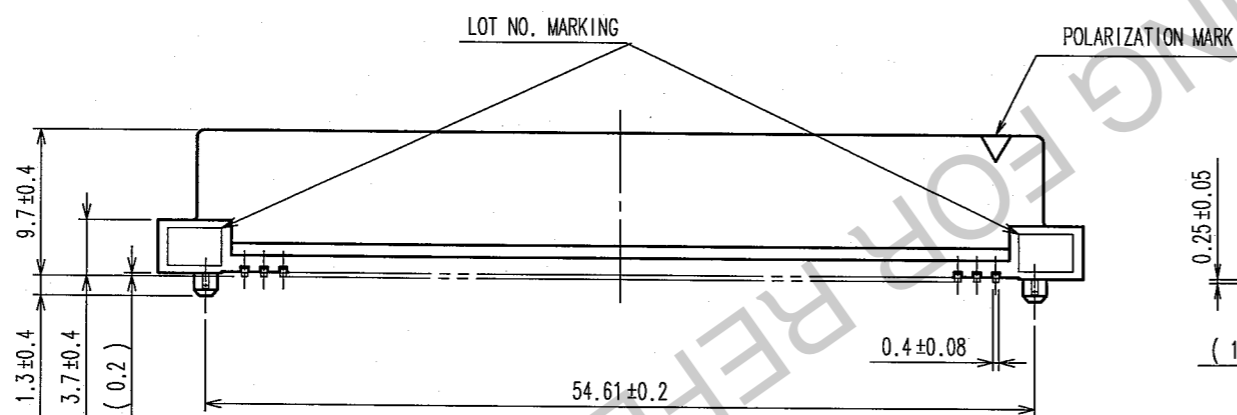
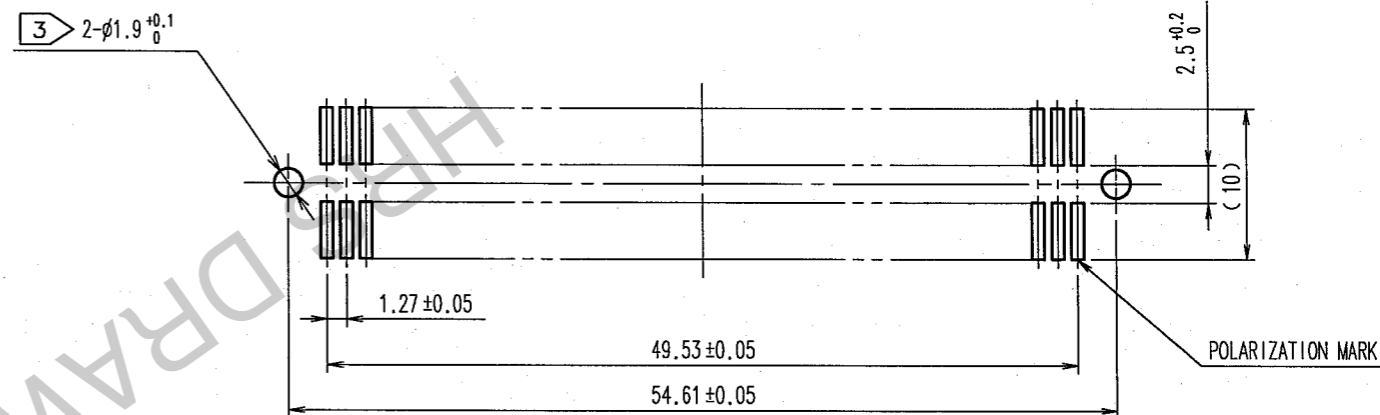

- NOTES 1 LEAD CO-PLANARITY SHALL BE 0.15 MAX.
 2 THE DIMENSIONS IN PARENTHESES ARE FOR REFERENCE.
 3 IN CASE OF THE AUTOMATED MOUNTING, RECOMMENDED HOLE DIAMETER OF BOSS IS SHOWN IN FIG.1.

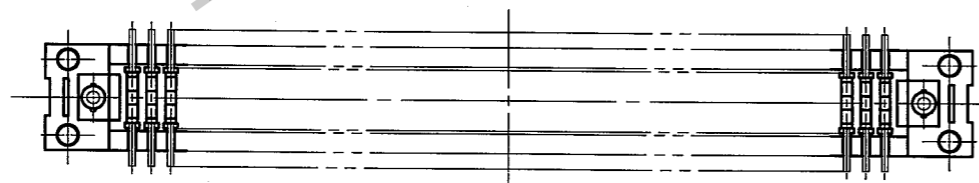

TO
PCK

1	POLYPHENYLENE SULFIDE	LIGHT BROWN (UL94V-0)	2	PHOSPHOR BRONZE	CONTACT AREA:GOLD 0.2μ m min. LEAD AREA:TIN 2μ m min. UNDER PLATING:NICKEL 1.5μ m min.
NO.	MATERIAL	FINISH, REMARKS	NO.	MATERIAL	FINISH, REMARKS
CODE NO. (OLD) CL			DRAWN H. Dai '05.09.02	DESIGNED H. Dai '05.09.02	CHECKED K. Ogawa '05.09.02
			APPROVED H. Okawa '05.09.02	RELEASED ..	
SCALE 2 : 1	DRAWING NO. EDC3-082422-21	PART NO. FX2-80S-1.27SV(71)		CODE NO. CL572-2107-0-71	1/1
UNITS mm	HRS HIROSE ELECTRIC CO., LTD				