



Chipsmall Limited consists of a professional team with an average of over 10 year of expertise in the distribution of electronic components. Based in Hongkong, we have already established firm and mutual-benefit business relationships with customers from,Europe,America and south Asia,supplying obsolete and hard-to-find components to meet their specific needs.

With the principle of “Quality Parts,Customers Priority,Honest Operation,and Considerate Service”,our business mainly focus on the distribution of electronic components. Line cards we deal with include Microchip,ALPS,ROHM,Xilinx,Pulse,ON,Everlight and Freescale. Main products comprise IC,Modules,Potentiometer,IC Socket,Relay,Connector.Our parts cover such applications as commercial,industrial, and automotives areas.

We are looking forward to setting up business relationship with you and hope to provide you with the best service and solution. Let us make a better world for our industry!



Contact us

Tel: +86-755-8981 8866 Fax: +86-755-8427 6832

Email & Skype: info@chipsmall.com Web: www.chipsmall.com

Address: A1208, Overseas Decoration Building, #122 Zhenhua RD., Futian, Shenzhen, China



IHM-B Modul mit schnellem Trench/Feldstopp IGBT3 und Emitter Controlled 3 Diode
 IHM-B module with fast Trench/Fieldstop IGBT3 and Emitter Controlled 3 diode

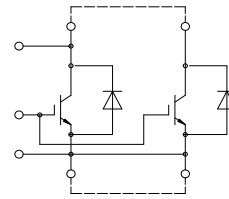

external connection
(to be done)

$V_{CES} = 3300V$
 $I_{C\ nom} = 1000A / I_{CRM} = 2000A$

Typische Anwendungen

- Chopper-Anwendungen
- Mittelspannungsantriebe
- Motorantriebe
- Traktionsumrichter
- USV-Systeme
- Windgeneratoren

Elektrische Eigenschaften

- Große DC-Festigkeit
- Hohe Kurzschlussrobustheit
- Niedrige Schaltverluste
- Niedriges V_{CEsat}
- Sehr große Robustheit
- $T_{vj\ op} = 150^{\circ}C$
- V_{CEsat} mit positivem Temperaturkoeffizienten

Mechanische Eigenschaften

- AlSiC Bodenplatte für erhöhte thermische Lastwechselfestigkeit
- Gehäuse mit CTI > 600
- IHM B Gehäuse
- Isolierte Bodenplatte

Typical Applications

- Chopper applications
- Medium voltage converters
- Motor drives
- Traction drives
- UPS systems
- Wind turbines

Electrical Features

- High DC stability
- High short-circuit capability
- Low switching losses
- Low V_{CEsat}
- Unbeatable robustness
- $T_{vj\ op} = 150^{\circ}C$
- V_{CEsat} with positive temperature coefficient

Mechanical Features

- AlSiC base plate for increased thermal cycling capability
- Package with CTI > 600
- IHM B housing
- Isolated base plate

Module Label Code

Barcode Code 128



DMX - Code



Content of the Code

Content of the Code	Digit
Module Serial Number	1 - 5
Module Material Number	6 - 11
Production Order Number	12 - 19
Datecode (Production Year)	20 - 21
Datecode (Production Week)	22 - 23

IGBT, Wechselrichter / IGBT, Inverter Höchstzulässige Werte / Maximum Rated Values

Kollektor-Emitter-Sperrspannung Collector-emitter voltage	$T_{vj} = -40^{\circ}\text{C}$ $T_{vj} = 150^{\circ}\text{C}$	V_{CES}	3300 3300	V
Kollektor-Dauergleichstrom Continuous DC collector current	$T_C = 95^{\circ}\text{C}$, $T_{vj\text{ max}} = 150^{\circ}\text{C}$	$I_{C\text{ nom}}$	1000	A
Periodischer Kollektor-Spitzenstrom Repetitive peak collector current	$t_P = 1\text{ ms}$	I_{CRM}	2000	A
Gate-Emitter-Spitzenspannung Gate-emitter peak voltage		V_{GES}	+/-20	V

Charakteristische Werte / Characteristic Values

			min.	typ.	max.		
Kollektor-Emitter-Sättigungsspannung Collector-emitter saturation voltage	$I_C = 1000\text{ A}$, $V_{GE} = 15\text{ V}$	$T_{vj} = 25^{\circ}\text{C}$	$V_{CE\text{ sat}}$	2,55	3,10	V	
	$I_C = 1000\text{ A}$, $V_{GE} = 15\text{ V}$	$T_{vj} = 125^{\circ}\text{C}$		3,00	3,45	V	
	$I_C = 1000\text{ A}$, $V_{GE} = 15\text{ V}$	$T_{vj} = 150^{\circ}\text{C}$		3,15		V	
Gate-Schwellenspannung Gate threshold voltage	$I_C = 48,0\text{ mA}$, $V_{CE} = V_{GE}$, $T_{vj} = 25^{\circ}\text{C}$		V_{GEth}	5,20	5,80	6,40	V
Gateladung Gate charge	$V_{GE} = -15\text{ V} \dots +15\text{ V}$, $V_{CE} = 1800\text{ V}$		Q_G		28,0		μC
Interner Gatewiderstand Internal gate resistor	$T_{vj} = 25^{\circ}\text{C}$		R_{Gint}		0,63		Ω
Eingangskapazität Input capacitance	$f = 1\text{ MHz}$, $T_{vj} = 25^{\circ}\text{C}$, $V_{CE} = 25\text{ V}$, $V_{GE} = 0\text{ V}$		C_{ies}		190		nF
Rückwirkungskapazität Reverse transfer capacitance	$f = 1\text{ MHz}$, $T_{vj} = 25^{\circ}\text{C}$, $V_{CE} = 25\text{ V}$, $V_{GE} = 0\text{ V}$		C_{res}		4,00		nF
Kollektor-Emitter-Reststrom Collector-emitter cut-off current	$V_{CE} = 3300\text{ V}$, $V_{GE} = 0\text{ V}$, $T_{vj} = 25^{\circ}\text{C}$		I_{CES}			5,0	mA
Gate-Emitter-Reststrom Gate-emitter leakage current	$V_{CE} = 0\text{ V}$, $V_{GE} = 20\text{ V}$, $T_{vj} = 25^{\circ}\text{C}$		I_{GES}			400	nA
Einschaltverzögerungszeit, induktive Last Turn-on delay time, inductive load	$I_C = 1000\text{ A}$, $V_{CE} = 1800\text{ V}$ $V_{GE} = \pm 15\text{ V}$ $R_{Gon} = 1,5\ \Omega$, $C_{GE} = 220\text{ nF}$	$T_{vj} = 25^{\circ}\text{C}$	t_{don}	0,60		μs	
		$T_{vj} = 125^{\circ}\text{C}$		0,60		μs	
		$T_{vj} = 150^{\circ}\text{C}$		0,60		μs	
Anstiegszeit, induktive Last Rise time, inductive load	$I_C = 1000\text{ A}$, $V_{CE} = 1800\text{ V}$ $V_{GE} = \pm 15\text{ V}$ $R_{Gon} = 1,5\ \Omega$, $C_{GE} = 220\text{ nF}$	$T_{vj} = 25^{\circ}\text{C}$	t_r	0,55		μs	
		$T_{vj} = 125^{\circ}\text{C}$		0,55		μs	
		$T_{vj} = 150^{\circ}\text{C}$		0,55		μs	
Abschaltverzögerungszeit, induktive Last Turn-off delay time, inductive load	$I_C = 1000\text{ A}$, $V_{CE} = 1800\text{ V}$ $V_{GE} = \pm 15\text{ V}$ $R_{Goff} = 2,3\ \Omega$, $C_{GE} = 220\text{ nF}$	$T_{vj} = 25^{\circ}\text{C}$	t_{doff}	3,00		μs	
		$T_{vj} = 125^{\circ}\text{C}$		3,20		μs	
		$T_{vj} = 150^{\circ}\text{C}$		3,20		μs	
Fallzeit, induktive Last Fall time, inductive load	$I_C = 1000\text{ A}$, $V_{CE} = 1800\text{ V}$ $V_{GE} = \pm 15\text{ V}$ $R_{Goff} = 2,3\ \Omega$, $C_{GE} = 220\text{ nF}$	$T_{vj} = 25^{\circ}\text{C}$	t_f	0,30		μs	
		$T_{vj} = 125^{\circ}\text{C}$		0,35		μs	
		$T_{vj} = 150^{\circ}\text{C}$		0,35		μs	
Einschaltverlustenergie pro Puls Turn-on energy loss per pulse	$I_C = 1000\text{ A}$, $V_{CE} = 1800\text{ V}$, $L_S = 85\text{ nH}$ $V_{GE} = \pm 15\text{ V}$, $di/dt = 3000\text{ A}/\mu\text{s}$ ($T_{vj} = 150^{\circ}\text{C}$) $R_{Gon} = 0,71\ \Omega$, $C_{GE} = 220\text{ nF}$	$T_{vj} = 25^{\circ}\text{C}$	E_{on}	1250		mJ	
		$T_{vj} = 125^{\circ}\text{C}$		1700		mJ	
		$T_{vj} = 150^{\circ}\text{C}$		1950		mJ	
Abschaltverlustenergie pro Puls Turn-off energy loss per pulse	$I_C = 1000\text{ A}$, $V_{CE} = 1800\text{ V}$, $L_S = 85\text{ nH}$ $V_{GE} = \pm 15\text{ V}$, $du/dt = 2100\text{ V}/\mu\text{s}$ ($T_{vj} = 150^{\circ}\text{C}$) $R_{Goff} = 2,3\ \Omega$, $C_{GE} = 220\text{ nF}$	$T_{vj} = 25^{\circ}\text{C}$	E_{off}	1050		mJ	
		$T_{vj} = 125^{\circ}\text{C}$		1400		mJ	
		$T_{vj} = 150^{\circ}\text{C}$		1550		mJ	
Kurzschlußverhalten SC data	$V_{GE} \leq 15\text{ V}$, $V_{CC} = 2500\text{ V}$ $V_{CEmax} = V_{CES} - L_{SCE} \cdot di/dt$ $t_P \leq 10\ \mu\text{s}$, $T_{vj} = 150^{\circ}\text{C}$		I_{SC}		4200		A
Wärmewiderstand, Chip bis Gehäuse Thermal resistance, junction to case	pro IGBT / per IGBT		R_{thJC}			11,1	K/kW
Wärmewiderstand, Gehäuse bis Kühlkörper Thermal resistance, case to heatsink	pro IGBT / per IGBT $\lambda_{Paste} = 1\text{ W}/(\text{m}\cdot\text{K})$ / $\lambda_{grease} = 1\text{ W}/(\text{m}\cdot\text{K})$		R_{thCH}			14,5	K/kW
Temperatur im Schaltbetrieb Temperature under switching conditions			$T_{vj\text{ op}}$	-40		150	$^{\circ}\text{C}$

Diode, Wechselrichter / Diode, Inverter

Höchstzulässige Werte / Maximum Rated Values

Periodische Spitzensperrspannung Repetitive peak reverse voltage	$T_{vj} = -40^{\circ}\text{C}$ $T_{vj} = 150^{\circ}\text{C}$	V_{RRM}	3300 3300	V
Dauergleichstrom Continuous DC forward current		I_F	1000	A
Periodischer Spitzenstrom Repetitive peak forward current	$t_P = 1 \text{ ms}$	I_{FRM}	2000	A
Grenzlastintegral I^2t - value	$V_R = 0 \text{ V}, t_P = 10 \text{ ms}, T_{vj} = 125^{\circ}\text{C}$ $V_R = 0 \text{ V}, t_P = 10 \text{ ms}, T_{vj} = 150^{\circ}\text{C}$	I^2t	260 245	kA^2s kA^2s
Spitzenverlustleistung Maximum power dissipation	$T_{vj} = 125^{\circ}\text{C}$	P_{RQM}	1600	kW
Mindesteinschaltdauer Minimum turn-on time		$t_{on \text{ min}}$	10,0	μs

Charakteristische Werte / Characteristic Values

		min.	typ.	max.	
Durchlassspannung Forward voltage	$I_F = 1000 \text{ A}, V_{GE} = 0 \text{ V}$		3,10	3,85	V
	$I_F = 1000 \text{ A}, V_{GE} = 0 \text{ V}$		2,75	3,25	V
	$I_F = 1000 \text{ A}, V_{GE} = 0 \text{ V}$		2,65		V
Rückstromspitze Peak reverse recovery current	$I_F = 1000 \text{ A}, -di_F/dt = 3000 \text{ A}/\mu\text{s} (T_{vj}=150^{\circ}\text{C})$		1000		A
	$V_R = 1800 \text{ V}$		1200		A
	$V_{GE} = -15 \text{ V}$		1250		A
Sperrverzögerungsladung Recovered charge	$I_F = 1000 \text{ A}, -di_F/dt = 3000 \text{ A}/\mu\text{s} (T_{vj}=150^{\circ}\text{C})$		450		μC
	$V_R = 1800 \text{ V}$		900		μC
	$V_{GE} = -15 \text{ V}$		1050		μC
Abschaltenergie pro Puls Reverse recovery energy	$I_F = 1000 \text{ A}, -di_F/dt = 3000 \text{ A}/\mu\text{s} (T_{vj}=150^{\circ}\text{C})$		450		mJ
	$V_R = 1800 \text{ V}$		1100		mJ
	$V_{GE} = -15 \text{ V}$		1300		mJ
Wärmewiderstand, Chip bis Gehäuse Thermal resistance, junction to case	pro Diode / per diode	R_{thJC}		19,8	K/kW
Wärmewiderstand, Gehäuse bis Kühlkörper Thermal resistance, case to heatsink	pro Diode / per diode $\lambda_{\text{Paste}} = 1 \text{ W}/(\text{m}\cdot\text{K})$ / $\lambda_{\text{grease}} = 1 \text{ W}/(\text{m}\cdot\text{K})$	R_{thCH}		16,5	K/kW
Temperatur im Schaltbetrieb Temperature under switching conditions		$T_{vj \text{ op}}$	-40	150	$^{\circ}\text{C}$

Modul / Module

Isolations-Prüfspannung Isolation test voltage	RMS, f = 50 Hz, t = 1 min.	V _{ISOL}	6,0			kV
Teilentladungs-Aussetzspannung Partial discharge extinction voltage	RMS, f = 50 Hz, Q _{PD} ≤ 10 pC	V _{ISOL}	2,6			kV
Kollektor-Emitter-Gleichsperrspannung DC stability	T _{vj} = 25°C, 100 fit	V _{CE D}	2100			V
Material Modulgrundplatte Material of module baseplate			AlSiC			
Kriechstrecke Creepage distance	Kontakt - Kühlkörper / terminal to heatsink Kontakt - Kontakt / terminal to terminal		32,2			mm
Luftstrecke Clearance	Kontakt - Kühlkörper / terminal to heatsink Kontakt - Kontakt / terminal to terminal		19,1			mm
Vergleichszahl der Kriechwegbildung Comperative tracking index		CTI	> 600			
			min.	typ.	max.	
Modulstreuinduktivität Stray inductance module		L _{sCE}		9,0		nH
Modulleitungswiderstand, Anschlüsse - Chip Module lead resistance, terminals - chip	T _c = 25°C, pro Schalter / per switch	R _{CC+EE'}		0,19		mΩ
Lagertemperatur Storage temperature		T _{stg}	-40		150	°C
Anzugsdrehmoment f. Modulmontage Mounting torque for modul mounting	Schraube M6 - Montage gem. gültiger Applikationsschrift Screw M6 - Mounting according to valid application note	M	4,25		5,75	Nm
Anzugsdrehmoment f. elektr. Anschlüsse Terminal connection torque	Schraube M4 - Montage gem. gültiger Applikationsschrift Screw M4 - Mounting according to valid application note Schraube M8 - Montage gem. gültiger Applikationsschrift Screw M8 - Mounting according to valid application note	M	1,8 8,0	- -	2,1 10	Nm Nm
Gewicht Weight		G		800		g

Ausgangskennlinie IGBT, Wechselrichter (typisch)
output characteristic IGBT, Inverter (typical)

$I_C = f(V_{CE})$
 $V_{GE} = 15\text{ V}$

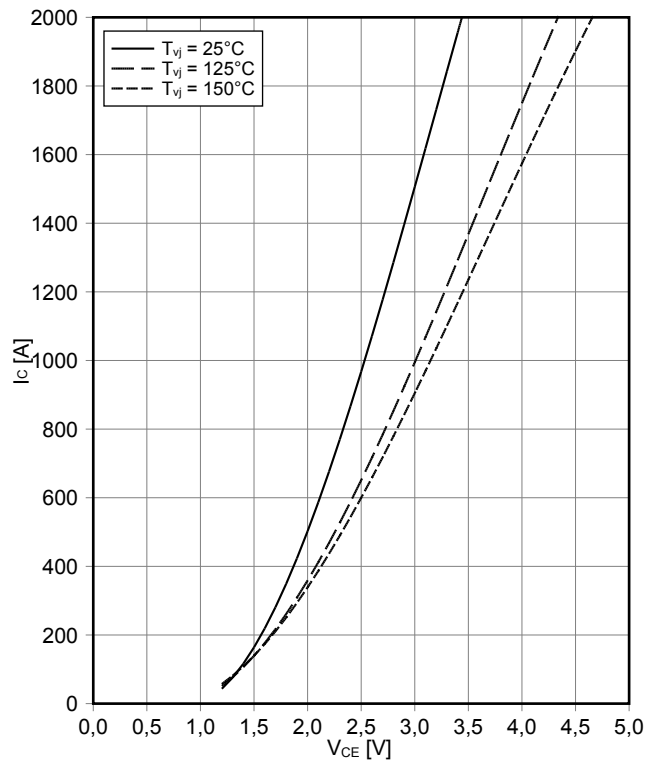

Ausgangskennlinienfeld IGBT, Wechselrichter (typisch)
output characteristic IGBT, Inverter (typical)

$I_C = f(V_{CE})$
 $T_{vj} = 150^\circ\text{C}$

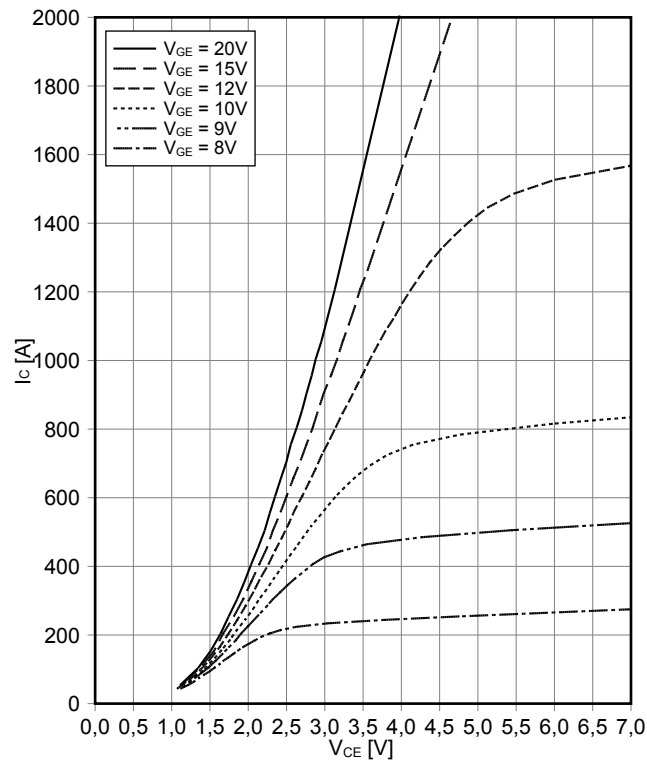

Übertragungscharakteristik IGBT, Wechselrichter (typisch)
transfer characteristic IGBT, Inverter (typical)

$I_C = f(V_{GE})$
 $V_{CE} = 20\text{ V}$

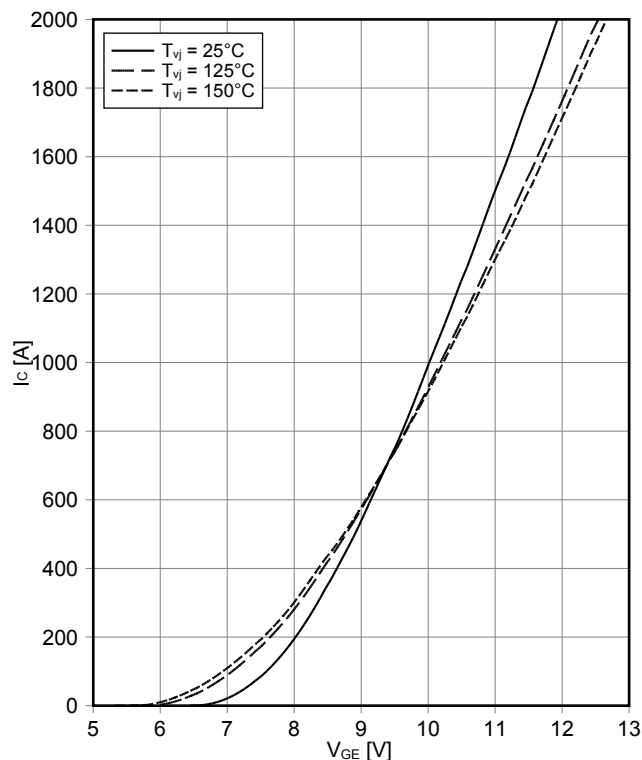

Schaltverluste IGBT, Wechselrichter (typisch)
switching losses IGBT, Inverter (typical)

$E_{on} = f(I_C)$, $E_{off} = f(I_C)$
 $V_{GE} = \pm 15\text{ V}$, $R_{Gon} = 0.71\ \Omega$, $R_{Goff} = 2.3\ \Omega$, $V_{CE} = 1800\text{ V}$, $C_{GE} = 220\text{ nF}$

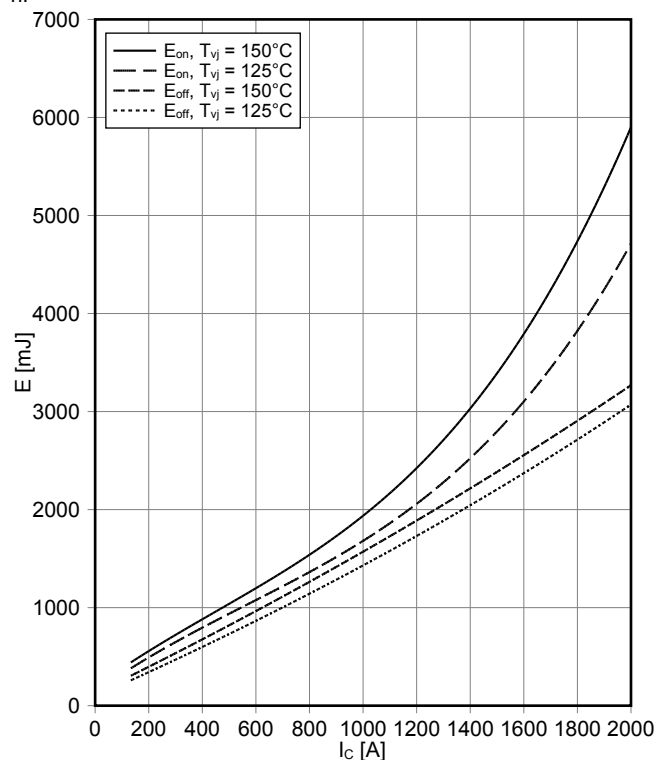

Schaltverluste IGBT, Wechselrichter (typisch) switching losses IGBT, Inverter (typical)

$E_{on} = f(R_G)$, $E_{off} = f(R_G)$
 $V_{GE} = \pm 15\text{ V}$, $I_C = 1000\text{ A}$, $V_{CE} = 1800\text{ V}$, $C_{GE} = 220\text{ nF}$

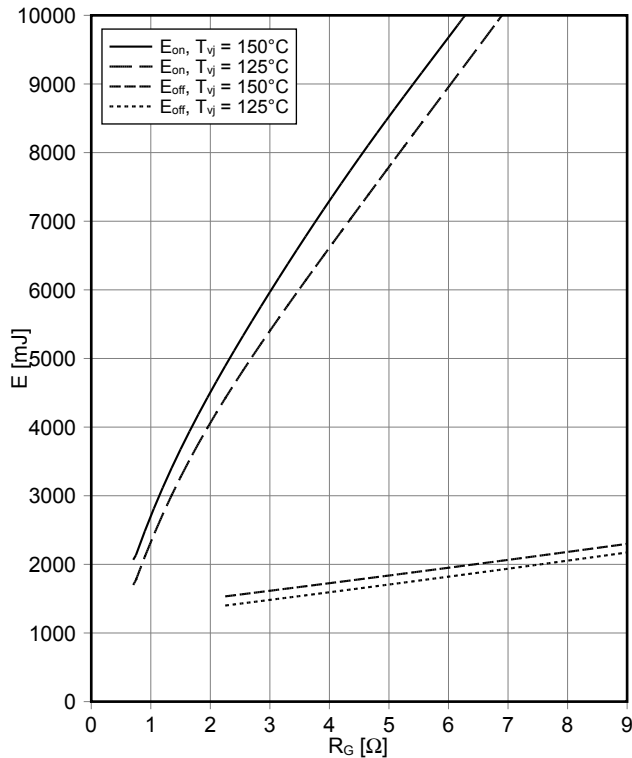

Transienter Wärmewiderstand IGBT, Wechselrichter transient thermal impedance IGBT, Inverter

$Z_{thJC} = f(t)$

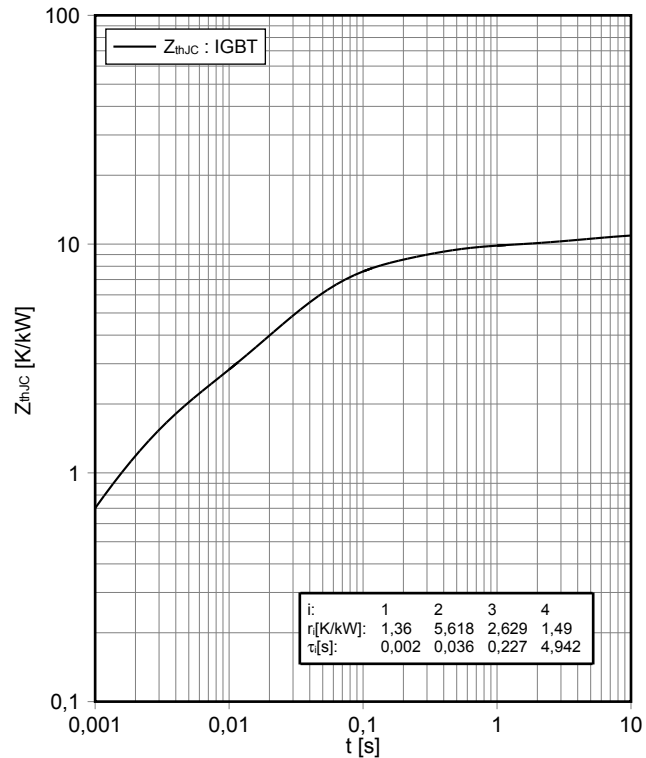

Sicherer Rückwärts-Arbeitsbereich IGBT, Wechselrichter (RBSOA)

reverse bias safe operating area IGBT, Inverter (RBSOA)

$I_C = f(V_{CE})$
 $V_{GE} = \pm 15\text{ V}$, $R_{Goff} = 2.3\ \Omega$, $T_{vj} = 150^\circ\text{C}$, $C_{GE} = 220\text{ nF}$

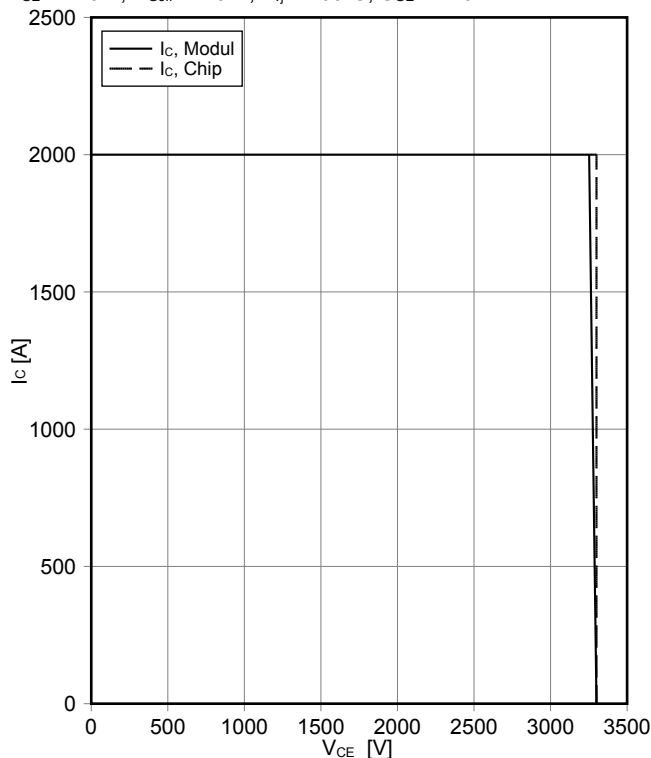

Durchlasskennlinie der Diode, Wechselrichter (typisch) forward characteristic of Diode, Inverter (typical)

$I_F = f(V_F)$

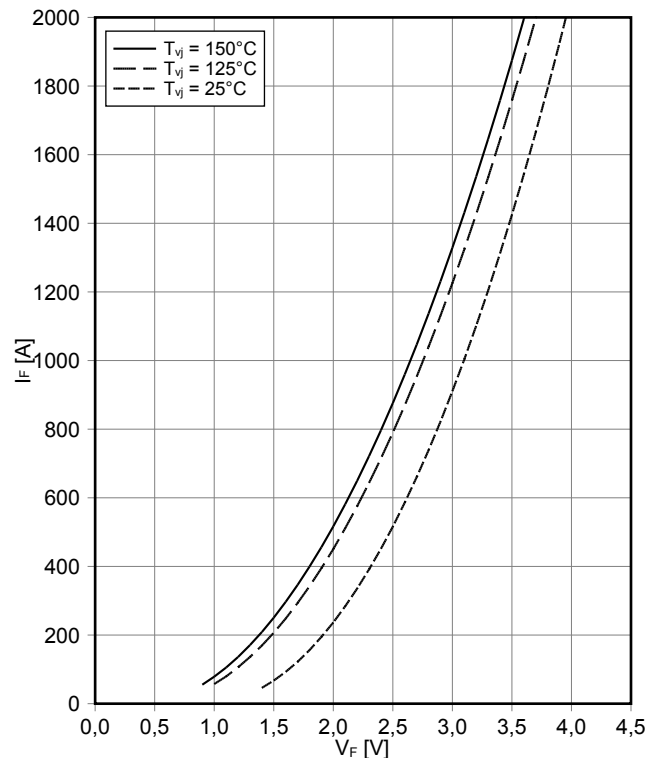

Schaltverluste Diode, Wechselrichter (typisch)
switching losses Diode, Inverter (typical)

$E_{rec} = f(I_F)$
 $R_{Gon} = 0.71 \Omega, V_{CE} = 1800 V$

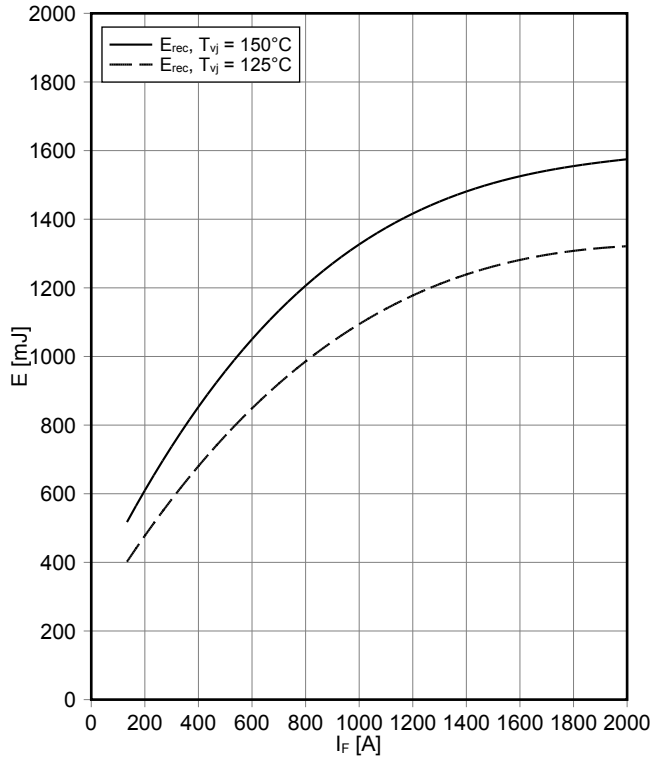

Schaltverluste Diode, Wechselrichter (typisch)
switching losses Diode, Inverter (typical)

$E_{rec} = f(R_G)$
 $I_F = 1000 A, V_{CE} = 1800 V$

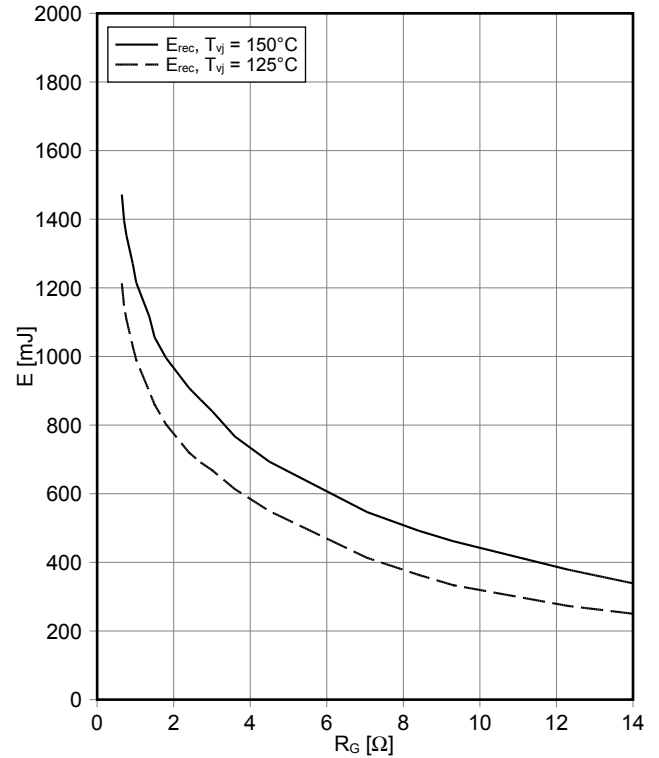

Transienter Wärmewiderstand Diode, Wechselrichter
transient thermal impedance Diode, Inverter

$Z_{thJC} = f(t)$

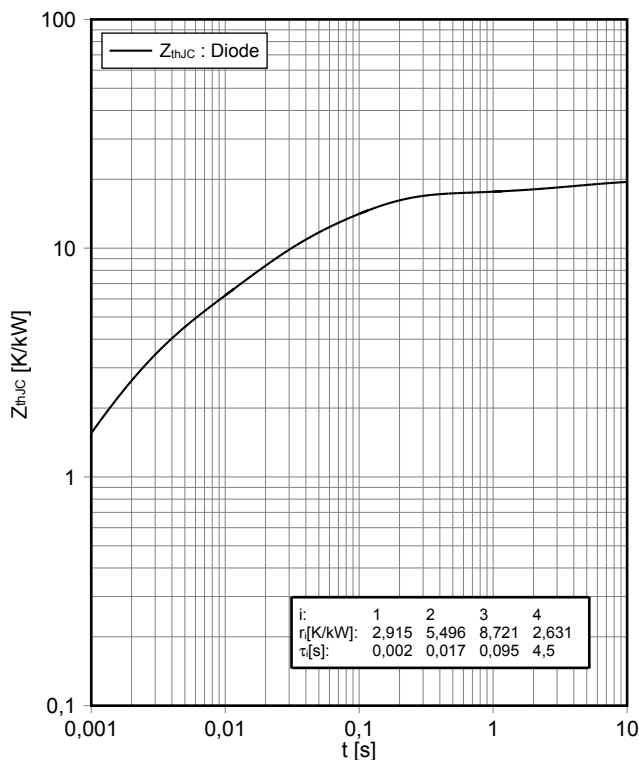

Sicherer Arbeitsbereich Diode, Wechselrichter (SOA)
safe operation area Diode, Inverter (SOA)

$I_R = f(V_R)$
 $T_{vj} = 150^\circ C$

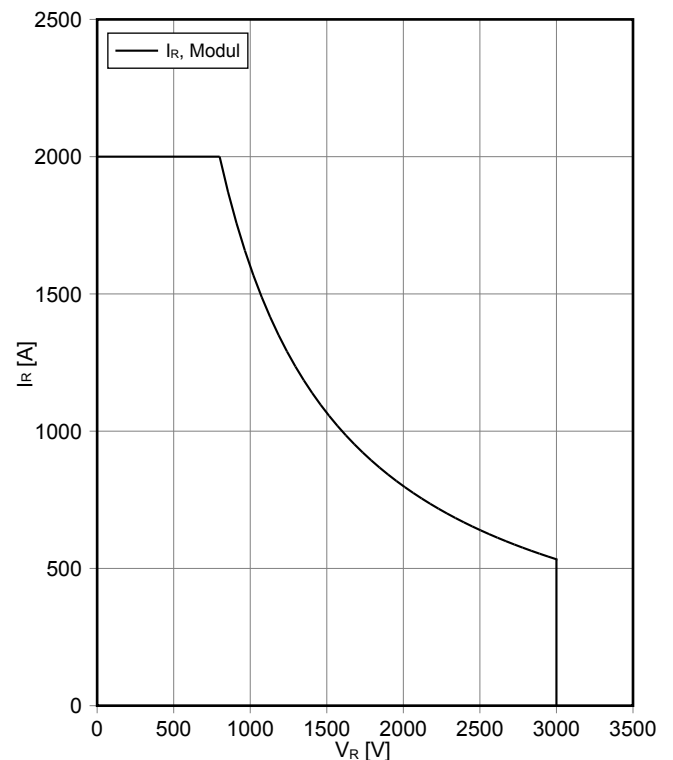

Schaltplan / Circuit diagram

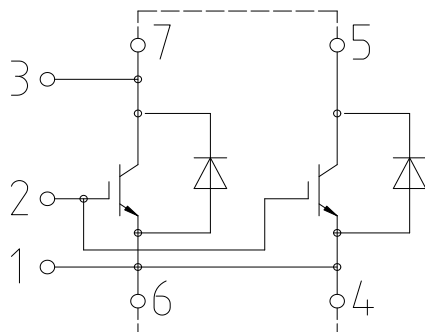

external connection
(to be done)

Gehäuseabmessungen / Package outlines

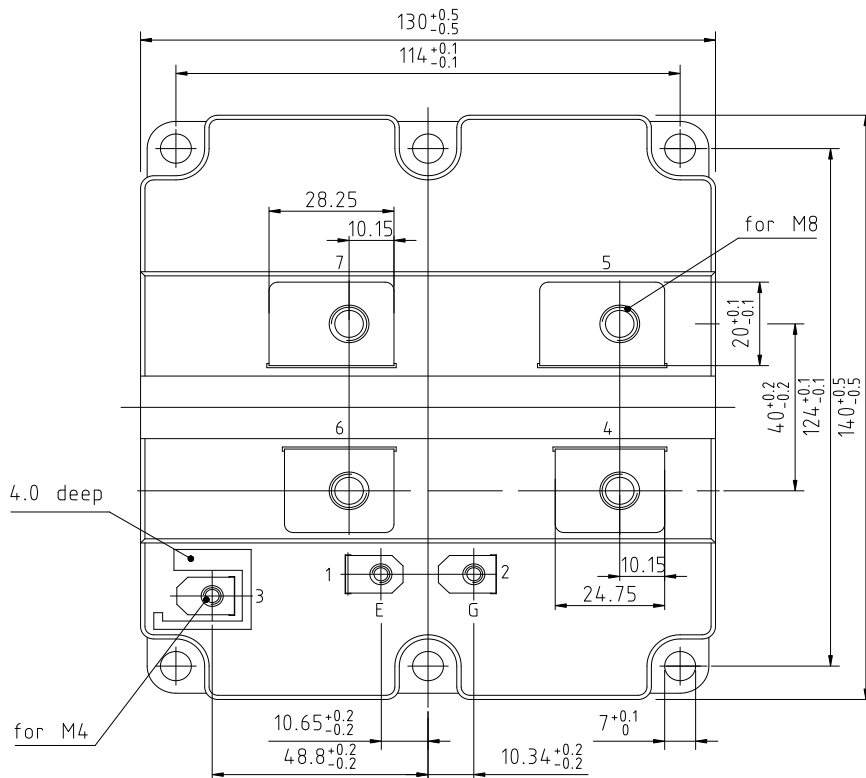
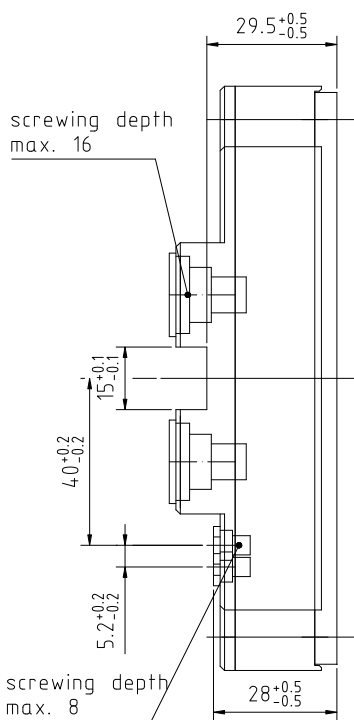
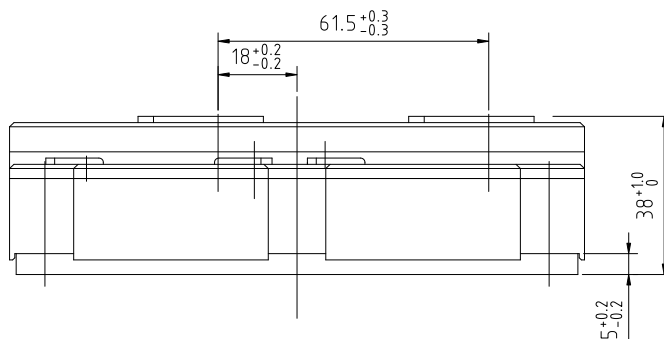

Trademarks of Infineon Technologies AG

μ HVIC™, μ IPM™, μ PFC™, AU-ConvertIR™, AURIX™, C166™, CanPAK™, CIPOS™, CIPURSE™, CoolIDP™, CoolGaN™, COOLiR™, CoolMOS™, CoolSET™, CoolSiC™, DAVE™, DI-POL™, DirectFET™, DrBlade™, EasyPIM™, EconoBRIDGE™, EconoDUAL™, EconoPACK™, EconoPIM™, EiceDRIVER™, eupec™, FCOS™, GaNpowIR™, HEXFET™, HITFET™, HybridPACK™, iMOTION™, IRAM™, ISOFACE™, IsoPACK™, LEDrivIR™, LITIX™, MIPAQ™, ModSTACK™, my-d™, NovalithIC™, OPTIGA™, OptiMOS™, ORIGA™, PowIRaudio™, PowIRstage™, PrimePACK™, PrimeSTACK™, PROFET™, PRO-SIL™, RASIC™, REAL3™, SmartLEWIS™, SOLID FLASH™, SPOC™, StrongIRFET™, SuplIRBuck™, TEMPFET™, TRENCHSTOP™, TriCore™, UHVIC™, XHP™, XMC™

Trademarks updated November 2015

Other Trademarks

All referenced product or service names and trademarks are the property of their respective owners.

Edition 2016-12-06

Published by
Infineon Technologies AG
81726 München, Germany

© 2016 Infineon Technologies AG.
All Rights Reserved.

Do you have a question about this document?
Email: erratum@infineon.com

WICHTIGER HINWEIS

Die in diesem Dokument enthaltenen Angaben stellen keinesfalls Garantien für die Beschaffenheit oder Eigenschaften des Produktes ("Beschaffenhheitsgarantie") dar. Für Beispiele, Hinweise oder typische Werte, die in diesem Dokument enthalten sind, und/oder Angaben, die sich auf die Anwendung des Produktes beziehen, ist jegliche Gewährleistung und Haftung von Infineon Technologies ausgeschlossen, einschließlich, ohne hierauf beschränkt zu sein, die Gewähr dafür, dass kein geistiges Eigentum Dritter verletzt ist.

Des Weiteren stehen sämtliche, in diesem Dokument enthaltenen Informationen, unter dem Vorbehalt der Einhaltung der in diesem Dokument festgelegten Verpflichtungen des Kunden sowie aller im Hinblick auf das Produkt des Kunden sowie die Nutzung des Infineon Produktes in den Anwendungen des Kunden anwendbaren gesetzlichen Anforderungen, Normen und Standards durch den Kunden.

Die in diesem Dokument enthaltenen Daten sind ausschließlich für technisch geschultes Fachpersonal bestimmt. Die Beurteilung der Eignung dieses Produktes für die beabsichtigte Anwendung sowie die Beurteilung der Vollständigkeit der in diesem Dokument enthaltenen Produktdaten für diese Anwendung obliegt den technischen Fachabteilungen des Kunden.

Sollten Sie von uns weitere Informationen im Zusammenhang mit dem Produkt, der Technologie, Lieferbedingungen bzw. Preisen benötigen, wenden Sie sich bitte an das nächste Vertriebsbüro von Infineon Technologies (www.infineon.com).

WARNHINWEIS

Aufgrund der technischen Anforderungen können Produkte gesundheitsgefährdende Substanzen enthalten. Bei Fragen zu den in diesem Produkt enthaltenen Substanzen, setzen Sie sich bitte mit dem nächsten Vertriebsbüro von Infineon Technologies in Verbindung.

Sofern Infineon Technologies nicht ausdrücklich in einem schriftlichen, von vertretungsberechtigten Infineon Mitarbeitern unterzeichneten Dokument zugestimmt hat, dürfen Produkte von Infineon Technologies nicht in Anwendungen eingesetzt werden, in welchen vernünftigerweise erwartet werden kann, dass ein Fehler des Produktes oder die Folgen der Nutzung des Produktes zu Personenverletzungen führen.

IMPORTANT NOTICE

The information given in this document shall in no event be regarded as a guarantee of conditions or characteristics ("Beschaffenhheitsgarantie"). With respect to any examples, hints or any typical values stated herein and/or any information regarding the application of the product, Infineon Technologies hereby disclaims any and all warranties and liabilities of any kind, including without limitation warranties of non-infringement of intellectual property rights of any third party.

In addition, any information given in this document is subject to customer's compliance with its obligations stated in this document and any applicable legal requirements, norms and standards concerning customer's products and any use of the product of Infineon Technologies in customer's applications.

The data contained in this document is exclusively intended for technically trained staff. It is the responsibility of customer's technical departments to evaluate the suitability of the product for the intended application and the completeness of the product information given in this document with respect to such application.

For further information on the product, technology, delivery terms and conditions and prices please contact your nearest Infineon Technologies office (www.infineon.com).

WARNINGS

Due to technical requirements products may contain dangerous substances. For information on the types in question please contact your nearest Infineon Technologies office.

Except as otherwise explicitly approved by Infineon Technologies in a written document signed by authorized representatives of Infineon Technologies, Infineon Technologies' products may not be used in any applications where a failure of the product or any consequences of the use thereof can reasonably be expected to result in personal injury.