



Chipsmall Limited consists of a professional team with an average of over 10 year of expertise in the distribution of electronic components. Based in Hongkong, we have already established firm and mutual-benefit business relationships with customers from,Europe,America and south Asia,supplying obsolete and hard-to-find components to meet their specific needs.

With the principle of “Quality Parts,Customers Priority,Honest Operation,and Considerate Service”,our business mainly focus on the distribution of electronic components. Line cards we deal with include Microchip,ALPS,ROHM,Xilinx,Pulse,ON,Everlight and Freescale. Main products comprise IC,Modules,Potentiometer,IC Socket,Relay,Connector.Our parts cover such applications as commercial,industrial, and automotives areas.

We are looking forward to setting up business relationship with you and hope to provide you with the best service and solution. Let us make a better world for our industry!



## Contact us

Tel: +86-755-8981 8866 Fax: +86-755-8427 6832

Email & Skype: info@chipsmall.com Web: www.chipsmall.com

Address: A1208, Overseas Decoration Building, #122 Zhenhua RD., Futian, Shenzhen, China





# PHB Series Short Stroke Pushbutton Switches

A

Pushbutton



## Features/Benefits

- Momentary or latching action
- Low cost, reliable contact design
- 2 & 4 pole configurations
- Sealed contacts
- Optional buttons
- RoHS compliant

## Typical Applications

- Computers and peripherals
- Instrumentation and measurement equipment
- Non-power, on-off switch applications

## Specifications

RATING: 1 A @ 15 V DC  
 DIELECTRIC STRENGTH (50 Hz/1 min.): 500 V DC between terminals or between terminals and frame for 1 minute  
 OPERATING LIFE: 10,000 cycles at rated load  
 CONTACT RESISTANCE: 20 m  $\Omega$ ohms initial  
 INSULATION RESISTANCE: 100 M  $\Omega$ ohms  
 TOTAL TRAVEL/LATCHING TRAVEL: 2.5mm ( $\pm$  0.5 mm) / 1.5mm ( $\pm$  0.5 mm) to latch EE option (push-push)  
 OPERATING FORCE:  
 2U option: 170 grams  $\pm$  100 grams (1.67  $\pm$  0.98N)  
 4U option: 230 grams  $\pm$  100 grams (2.26  $\pm$  0.98N)  
 OPERATING TEMPERATURE: -10°C to 60°C  
 BOUNCE TIME:  $\leq$ 10 ms  
 SEALING: Sealed contacts.  
 PACKAGING: Switches; PHB2 models: 84 pcs per tray; PHB4 models 72 pcs per tray  
 Optional Caps; Bulk bag - 100 caps per bag

## Materials

FIXED TERMINAL: Brass, silver plated  
 MOVABLE CONTACT: Phosphor bronze, silver plated  
 COVER: PA 66 Black  
 COVER TO BASE RETAINING CLIP: POM  
 ACTUATOR: POM  
 RETURN SPRING: Stainless steel  
 SPRING RETAINING RING: Steel, nickel plate  
 BASE: Phenolic resin  
 TERMINAL SEAL: Epoxy.

**NOTE:** Specifications and materials listed above are for switches with standard options. For information on specific and custom switches, consult Customer Service Center.

## Build-A-Switch

To order, simply select desired option from each category and place in the appropriate box. For additional options not shown in catalog, consult Customer Service Center.

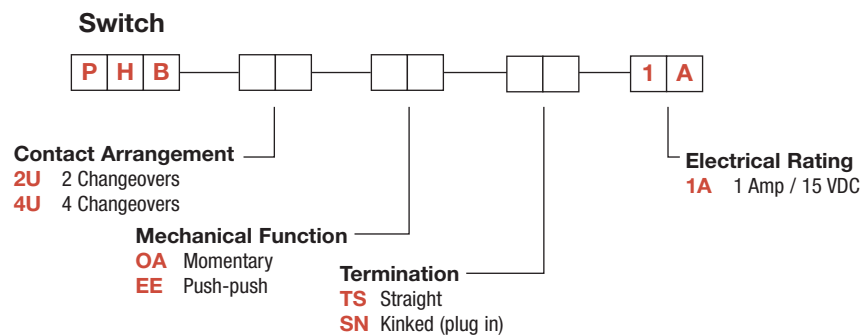

## Caps (order separately)



INDEXED	COLOR	RECTANGULAR	COLOR	ROUND	COLOR	SQUARE	COLOR
G001A	BLACK	G002A	BLACK	G003A	BLACK	G004A	BLACK
G001G	GRAY	G002G	GRAY	G003G	GRAY	G004G	GRAY
G001I	IVORY	G002I	IVORY	G003I	IVORY	G004I	IVORY
G001R	RED	G002R	RED	G003R	RED	G004R	RED



Dimensions are shown: Inches (mm)  
 Specifications and dimensions subject to change

# PHB Series Short Stroke Pushbutton Switches



A

Pushbutton

## TERMINATION

**TS** STRAIGHT

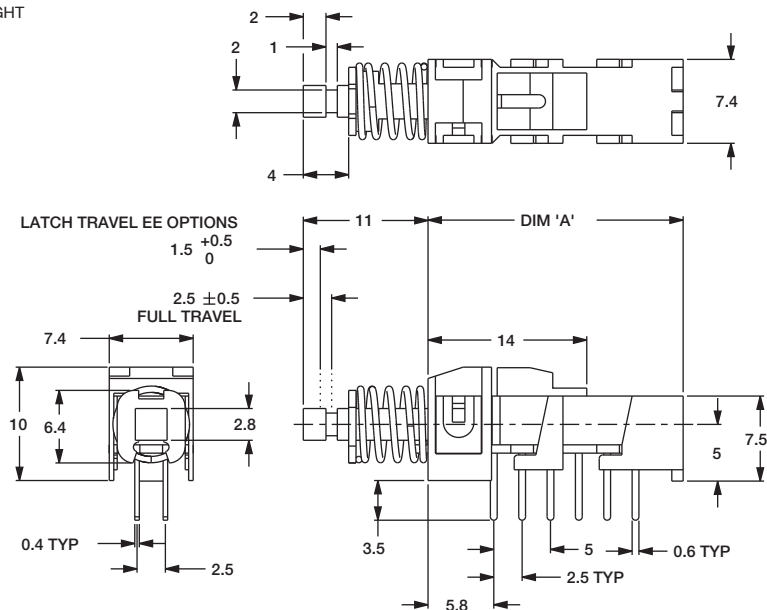

**SN** KINKED (PLUG IN)

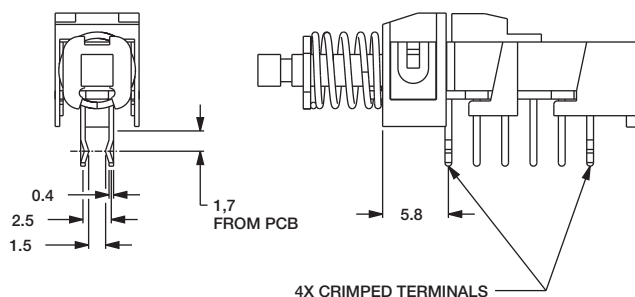

POLES	MODEL NO.	DIM 'A'	ACTION
4	PHB4UEE1A	22,5	PUSH/PUSH
	PHB4U0A1A	22,5	MOMENTARY
2	PHB2UEE1A	15,0	PUSH/PUSH
	PHB2U0A1A	15,0	MOMENTARY

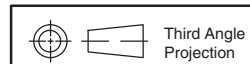
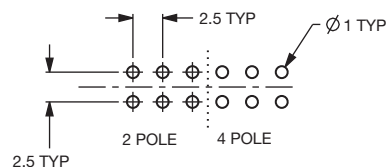
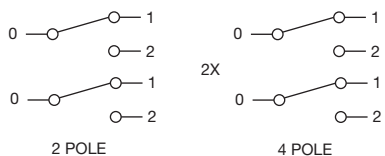

Dimensions are shown: mm  
Specifications and dimensions subject to change



# PHB Series Short Stroke Pushbutton Switches

## CAPS

Pushbutton  
A

### Indexed

- G001A** Black
- G001G** Gray
- G001I** Ivory
- G001R** Red

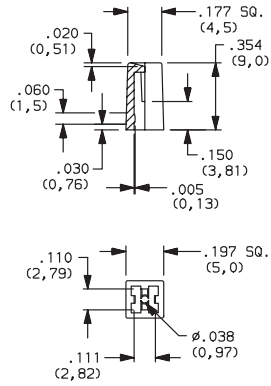
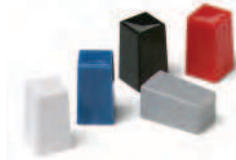

### Rectangular

- G002A** Black
- G002G** Gray
- G002I** Ivory
- G002R** Red

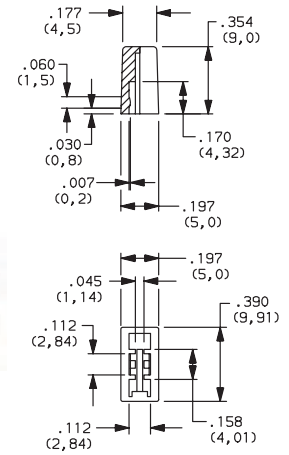

### Round

- G003A** Black
- G003G** Gray
- G003I** Ivory
- G003R** Red

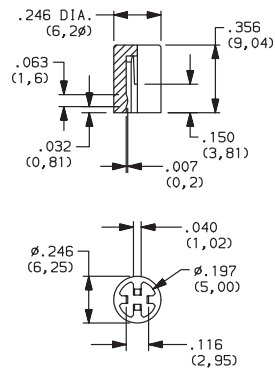

### Square

- G004A** Black
- G004G** Gray
- G004I** Ivory
- G004R** Red

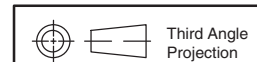
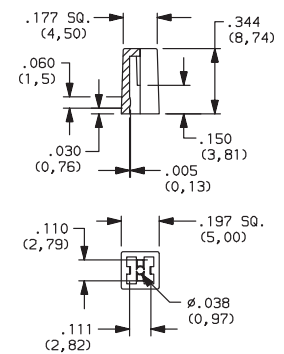
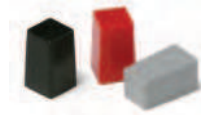

Dimensions are shown: Inches (mm)  
Specifications and dimensions subject to change