



Chipsmall Limited consists of a professional team with an average of over 10 year of expertise in the distribution of electronic components. Based in Hongkong, we have already established firm and mutual-benefit business relationships with customers from,Europe,America and south Asia,supplying obsolete and hard-to-find components to meet their specific needs.

With the principle of “Quality Parts,Customers Priority,Honest Operation,and Considerate Service”,our business mainly focus on the distribution of electronic components. Line cards we deal with include Microchip,ALPS,ROHM,Xilinx,Pulse,ON,Everlight and Freescale. Main products comprise IC,Modules,Potentiometer,IC Socket,Relay,Connector.Our parts cover such applications as commercial,industrial, and automotives areas.

We are looking forward to setting up business relationship with you and hope to provide you with the best service and solution. Let us make a better world for our industry!



Contact us

Tel: +86-755-8981 8866 Fax: +86-755-8427 6832

Email & Skype: info@chipsmall.com Web: www.chipsmall.com

Address: A1208, Overseas Decoration Building, #122 Zhenhua RD., Futian, Shenzhen, China



G3VM-81HR/101HR/101HR1

MOS FET Relays SOP 6-pin, High-current and Low-ON-resistance Type

MOS FET Relays in SOP 6-pin packages that achieve the low ON resistance and high switching capacitance of a mechanical relay

- Load voltage: 80 V/100 V
- 80-V Relay: Continuous load current of 1.25 A (2.5 A) max.*
- 100-V Relay: Continuous load current of 2 A (4 A) max.*

* Values in parentheses are for connection C.



Note: The actual product is marked differently from the image shown here.

RoHS Compliant

Application Examples

- Semiconductor test equipment
- Security equipment
- Amusement equipment
- Communication equipment
- Industrial equipment
- Test & Measurement equipment
- Power circuit

Package (Unit : mm, Average)

SOP 6-pin

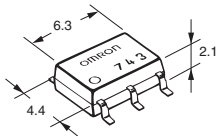

Note: The actual product is marked differently from the image shown here.

Model Number Legend

G3VM-□□□□□
1 2 3 4 5

- 1. Load Voltage**
8 : 80 V
10 : 100 V
- 2. Contact form**
1 : 1a (SPST-NO)
- 3. Package**
H : SOP 6-pin
- 4. Additional functions**
R: Low ON resistance
- 5. Other informations**
When specifications overlap, serial code is added in the recorded order.

Ordering Information

Package	Contact form	Terminals	Load voltage (peak value) *	Continuous load current (peak value) *		Stick packaging		Tape packaging	
				Connection A, B	Connection C	Model	Minimum package quantity	Model	Minimum package quantity
SOP6	1a (SPST-NO)	Surface-mounting Terminals	80 V	1.25 A	2.5 A	G3VM-81HR	75	G3VM-81HR(TR)	2,500
			100 V	1.4 A	2.8 A	G3VM-101HR		G3VM-101HR(TR)	2,500
			100 V	2.0 A	4.0 A	G3VM-101HR1		G3VM-101HR1(TR05)	500

* The AC peak and DC value are given for the load voltage and continuous load current.

Note: To order tape packaging for Relays with surface-mounting terminals, add "(TR)" to the end of the model number.

SOP 6-pin

Absolute Maximum Ratings (Ta = 25°C)

Item		Symbol	G3VM-81HR	G3VM-101HR	G3VM-101HR1	Unit	Measurement conditions	
Input	LED forward current	I_F	50	30		mA		
	LED forward current reduction rate	$\Delta I_F/^\circ\text{C}$	-0.5	-0.3		mA/°C	Ta ≥ 25°C	
	LED reverse voltage	V_R	5			V		
	Connection temperature	T_J	125			°C		
Load voltage (AC peak/DC)		V_{OFF}	80	100		V		
Output	Continuous load current	Connection A	I_o	1250	1400	2000	mA	Connection A: AC peak/DC Connection B and C: DC
		Connection B		2500	2800	4000		
		Connection C						
	ON current reduction rate	Connection A	$\Delta I_o/^\circ\text{C}$	-12.5	-18.7	-20	mA/°C	G3VM-101HR : Ta ≥ 50°C Others : Ta ≥ 25°C
		Connection B		-25.0	-37.3	-40		
		Connection C						
Pulse ON current	I_{op}	3.75	4	6	A	t=100 ms, Duty=1/10		
Connection temperature	T_J	125			°C			
Dielectric strength between I/O (See note 1.)		V_{I-O}	1500			Vrms	AC for 1 min	
Ambient operating temperature		T_a	-20 to +85	-40 to +85		°C	With no icing or condensation	
Ambient storage temperature		T_{stg}	-40 to +125	-55 to +125		°C		
Soldering temperature		-	260			°C	10 s	

Note: 1. The dielectric strength between the input and output was checked by applying voltage between all pins as a group on the LED side and all pins as a group on the light-receiving side.

Connection Diagram

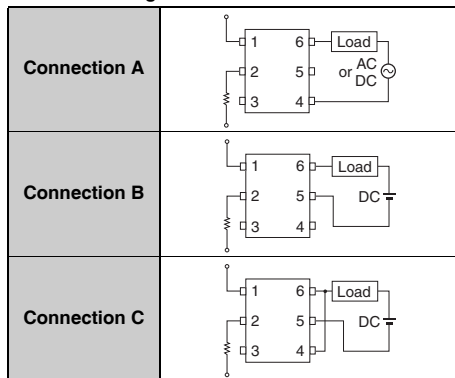

Electrical Characteristics (Ta = 25°C)

Item		Symbol		G3VM-81HR	G3VM-101HR	G3VM-101HR1	Unit	Measurement conditions	
Input	LED forward voltage	VF	Minimum	1.0	1.18		V	IF=10 mA	
			Typical	1.15	1.33				
			Maximum	1.3	1.48				
	Reverse current	IR	Maximum	10			μA	VR=5 V	
	Capacitance between terminals	CT	Typical	15	70		pF	V=0, f=1 MHz	
	Trigger LED forward current	IFT	Typical	2	0.4		mA	G3VM-81HR : Io=1250 mA Others : Io=100 mA	
Maximum			5	3					
Release LED forward current	IFC	Minimum	0.2	0.1		mA	IOFF=10 μA		
Output	Maximum resistance with output ON	RON	Typical	Connection A	0.11	0.1	0.045	Ω	G3VM-81HR : IF=5 mA, Io= Continuous load current ratings G3VM-101HR/101HR1 : IF=5 mA, Io= Continuous load current ratings, t < 1 s
				Connection B	0.06	0.05	0.022		
				Connection C	0.03	0.025	0.011		
			Maximum	Connection A	0.15	0.2	0.07		
				Connection B	0.08	0.1	0.035		
				Connection C	0.04	-	0.018		
Current leakage when the relay is open	ILEAK	Typical	1.2	-	-	nA	G3VM-81HR : VOFF=20 V, Ta=50°C Others : VOFF= Load voltage ratings		
		Maximum	1.5	10	1000				
Capacitance between terminals	COFF	Typical	460	1000	500	pF	G3VM-81HR : V=0, f=100 MHz Others : V=0, f=1 MHz		
		Maximum	1000	-	-				
Capacitance between I/O terminals	CI-O	Typical	0.8			pF	f=1 MHz, VS=0 V		
Insulation resistance between I/O terminals	RI-O	Minimum	1000			MΩ	VI-O=500 VDC, RoH≤60%		
		Typical	10 ⁸						
Turn-ON time	TON	Typical	2.0	1.0	1.1	ms	IF=5 mA, RL=200 Ω, VDD=20 V (See note 2.)		
		Maximum	3.0	5.0					
Turn-OFF time	TOFF	Typical	0.7	0.15	0.1	ms	IF=5 mA, RL=200 Ω, VDD=20 V (See note 2.)		
		Maximum	1.0						

Note: 2. Turn-ON and Turn-OFF Times

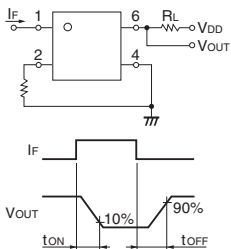

Recommended Operating Conditions

For usage with high reliability, Recommended Operation Conditions is a measure that takes into account the derating of Absolute Maximum Ratings and Electrical Characteristics.

Each item on this list is an independent condition, so it is not simultaneously satisfy several conditions.

Item	Symbol		G3VM-81HR	G3VM-101HR	G3VM-101HR1	Unit
Load voltage (AC peak/DC)	VDD	Maximum	64	100	80	V
Operating LED forward current	IF	Minimum	5			mA
		Typical	-	7.5	10	
		Maximum	30	20	25	
Continuous load current (AC peak/DC)	Io	Maximum	1250	1100	2000	
Ambient operating temperature	Ta	Minimum	25	-20		°C
		Maximum	60	65		

Spacing and Insulation

Item	Minimum	Unit
Creepage distances	4.0	mm
Clearance distances	4.0	
Internal isolation thickness	0.1	

Engineering Data

LED forward current vs. Ambient temperature

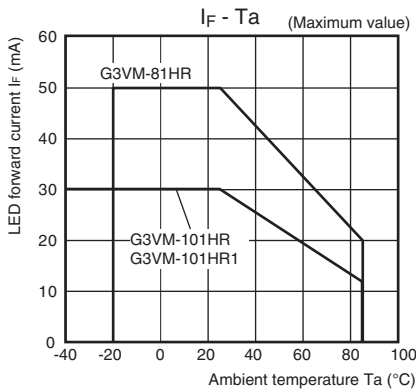

Continuous load current vs. Ambient temperature G3VM-101HR/101HR1

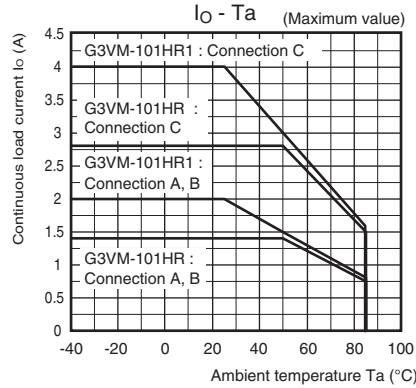

G3VM-81HR

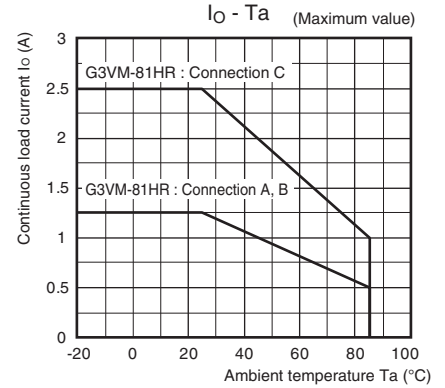

LED forward current vs. LED forward voltage

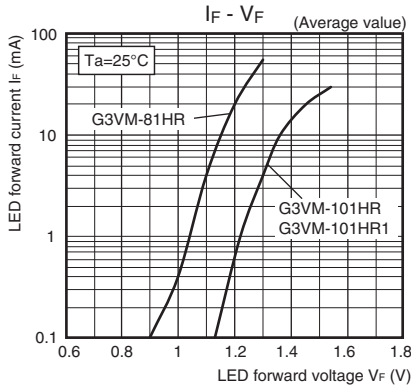

Continuous load current vs. On-state voltage

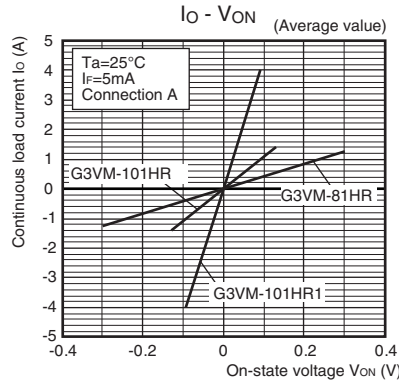

On-state resistance vs. Ambient temperature

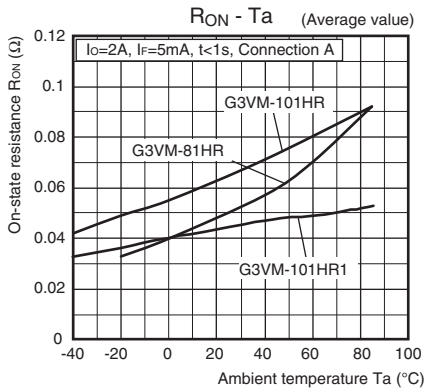

Trigger LED forward current vs. Ambient temperature G3VM-101HR/101HR1

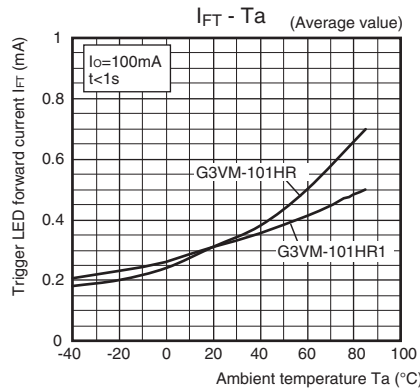

G3VM-81HR

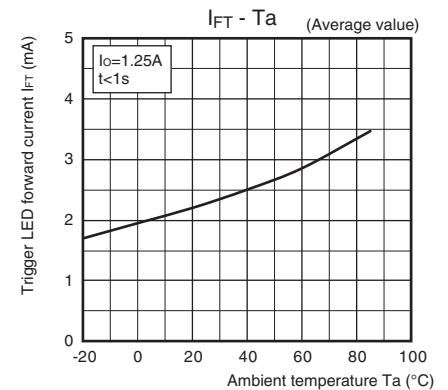

Turn ON, Turn OFF time vs. LED forward current G3VM-81HR/101HR

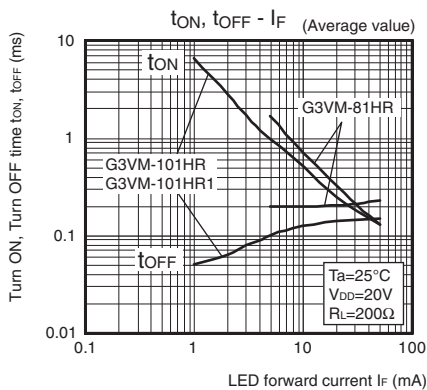

S
O
P

G
3
V
M
-
8
1
H
R
/
1
0
1
H
R
/
1
0
1
H
R
1

Engineering Data

Turn ON, Turn OFF time vs. Ambient temperature

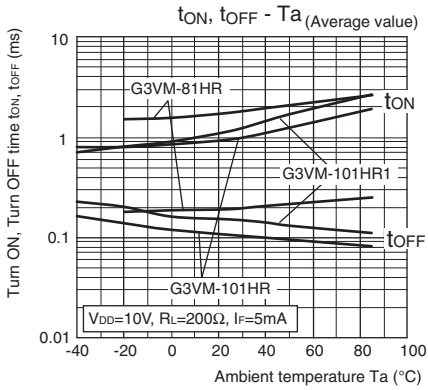

Current leakage vs. Load voltage

G3VM-101HR

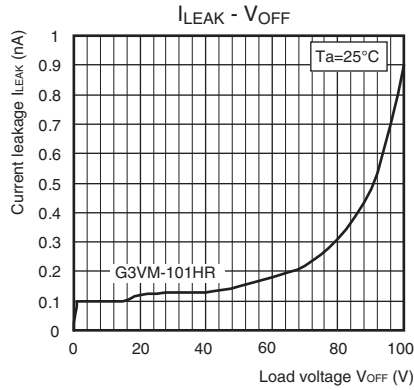

Current leakage vs. Ambient temperature

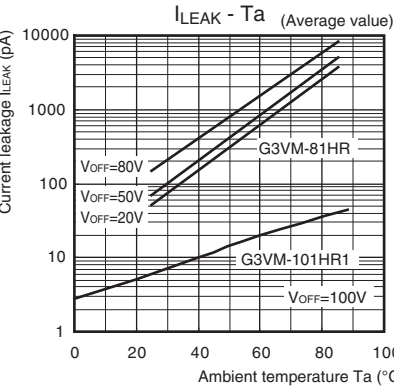

Output terminal capacitance vs. Load voltage

G3VM-101HR

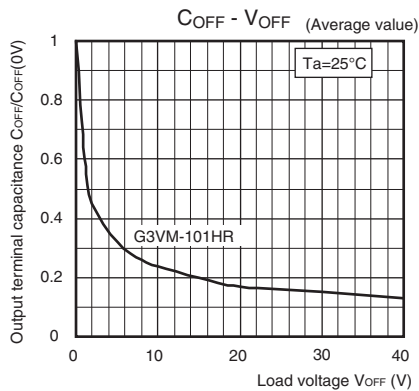

Appearance / Terminal Arrangement / Internal Connections

● Appearance

SOP (Small Outline Package)

SOP 6-pin

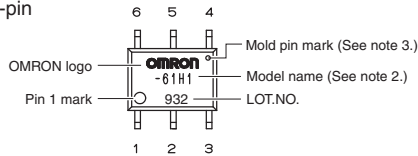

- Note: 1.** The actual product is marked differently from the image shown here.
Note: 2. "G3VM" does not appear in the model number on the Relay.
Note: 3. The indentation in the corner diagonally opposite from the pin 1 mark is from a pin on the mold.

● Terminal Arrangement/Internal Connections (Top View)

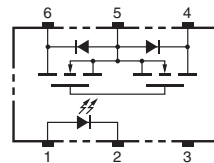

■ Dimensions (Unit: mm)

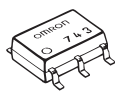

Surface-mounting Terminals

Weight: 0.13 g

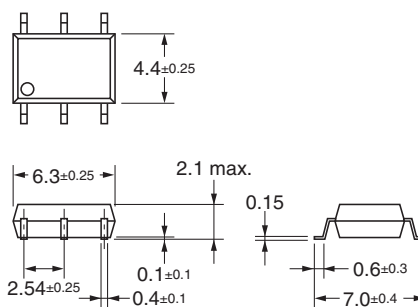

Actual Mounting Pad Dimensions

(Recommended Value, Top View)

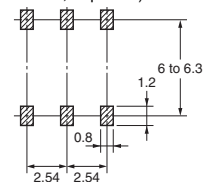

Note: The actual product is marked differently from the image shown here.

■ Approved Standards

UL recognized

Approved Standards	Contact form	File No.
UL (recognized)	1a (SPST-NO)	E80555

■ Safety Precautions

- Refer to the *Common Precautions for All MOS FET Relays* for precautions that apply to all MOS FET Relays.

• Application examples provided in this document are for reference only. In actual applications, confirm equipment functions and safety before using the product.
 • Consult your OMRON representative before using the product under conditions which are not described in the manual or applying the product to nuclear control systems, railroad systems, aviation systems, vehicles, combustion systems, medical equipment, amusement machines, safety equipment, and other systems or equipment that may have a serious influence on lives and property if used improperly. Make sure that the ratings and performance characteristics of the product provide a margin of safety for the system or equipment, and be sure to provide the system or equipment with double safety mechanisms.

Note: Do not use this document to operate the Unit.