



Chipsmall Limited consists of a professional team with an average of over 10 year of expertise in the distribution of electronic components. Based in Hongkong, we have already established firm and mutual-benefit business relationships with customers from,Europe,America and south Asia,supplying obsolete and hard-to-find components to meet their specific needs.

With the principle of “Quality Parts,Customers Priority,Honest Operation,and Considerate Service”,our business mainly focus on the distribution of electronic components. Line cards we deal with include Microchip,ALPS,ROHM,Xilinx,Pulse,ON,Everlight and Freescale. Main products comprise IC,Modules,Potentiometer,IC Socket,Relay,Connector.Our parts cover such applications as commercial,industrial, and automotives areas.

We are looking forward to setting up business relationship with you and hope to provide you with the best service and solution. Let us make a better world for our industry!



Contact us

Tel: +86-755-8981 8866 Fax: +86-755-8427 6832

Email & Skype: info@chipsmall.com Web: www.chipsmall.com

Address: A1208, Overseas Decoration Building, #122 Zhenhua RD., Futian, Shenzhen, China



G3VM-2L/2FL

MOS FET Relays

Current-limiting Models with 350-V Load Voltage.

- Current limit 150 to 300 mA.

RoHS compliant



Note: The actual product is marked differently from the image shown here.

Application Examples

- Communication equipment
- Test & Measurement equipment

Terminal Arrangement/Internal Connections

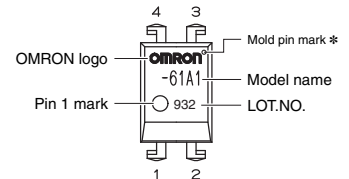
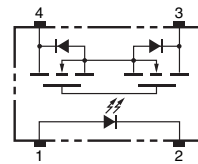

Note: The actual product is marked differently from the image shown here.
* The indentation in the corner diagonally opposite from the pin 1 mark is from a pin on the mold.

List of Models

Package type	Contact form	Terminals	Load voltage (peak value) *	Model	Current limit	Minimum package quantity	
						Number per tube	Number per tape and reel
DIP4	1a (SPST-NO)	PCB Terminals	350 V	G3VM-2L	Available	100	-
		Surface-mounting Terminals		G3VM-2FL			
				G3VM-2FL(TR)			

* The AC peak and DC value are given for the load voltage.

Absolute Maximum Ratings (Ta = 25°C)

Item	Symbol	Rating	Unit	Measurement conditions	
Input	LED forward current	IF	50	mA	
	Repetitive peak LED forward current	IFP	1	A	100 μs pulses, 100 pps
	LED forward current reduction rate	ΔIF/°C	-0.5	mA/°C	Ta ≥ 25°C
	LED reverse voltage	VR	6	V	
Connection temperature		TJ	125	°C	
Output	Load voltage (AC peak/DC)	V _{OFF}	350	V	
	Continuous load current (AC peak/DC)	Io	120	mA	
	ON current reduction rate	ΔIo/°C	-1.2	mA/°C	Ta ≥ 25°C
	Connection temperature		TJ	125	°C
Dielectric strength between I/O (See note 1.)		V _{I-O}	2500	Vrms	AC for 1 min
Ambient operating temperature		Ta	-40 to +85	°C	With no icing or condensation
Ambient storage temperature		Tstg	-55 to +125	°C	With no icing or condensation
Soldering temperature		-	260	°C	10 s

Note: 1. The dielectric strength between the input and output was checked by applying voltage between all pins as a group on the LED side and all pins as a group on the light-receiving side.

Electrical Characteristics (Ta = 25°C)

Item	Symbol	Minimum	Typical	Maximum	Unit	Measurement conditions	
Input	LED forward voltage	V _F	1.0	1.15	1.3	V	IF = 10 mA
	Reverse current	I _R	-	-	10	μA	VR = 6 V
	Capacity between terminals	CT	-	30	-	pF	V = 0, f = 1 MHz
	Trigger LED forward current	I _{FT}	-	1	3	mA	Io = 120 mA
Turn-OFF LED forward current		I _{FC}	0.1	-	-	mA	IOFF = 10 μA
Output	Maximum resistance with output ON	RON	-	22	35	Ω	IF = 5 mA, Io = 120 mA
	Current leakage when the relay is open	I _{LEAK}	-	-	1.0	μA	V _{OFF} = 350 V
	Capacity between terminals	COFF	-	40	-	pF	V = 0, f = 1 MHz
Limit current		I _{LIM}	150	-	300	mA	IF = 5 mA, V _{DD} = 5 V, t = 5 ms
Capacity between I/O terminals		CI-O	-	0.8	-	pF	f = 1 MHz, Vs = 0 V
Insulation resistance between I/O terminals		RI-O	1000	10 ⁸	-	MΩ	VI-O = 500 VDC, RoH ≤ 60%
Turn-ON time		t _{ON}	-	-	1.0	ms	IF = 5 mA, RL = 200 Ω, V _{DD} = 20 V(See note 2.)
Turn-OFF time		t _{OFF}	-	-	1.0	ms	

Note: 2. Turn-ON and Turn-OFF Times

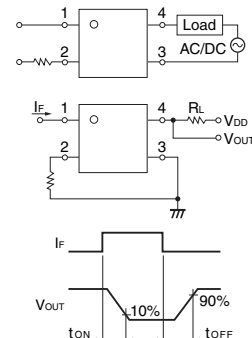

Recommended Operating Conditions

Use the G3VM under the following conditions so that the Relay will operate properly.

Item	Symbol	Minimum	Typical	Maximum	Unit
Load voltage (AC peak/DC)	V _{DD}	-	-	280	V
Operating LED forward current	I _F	5	7.5	25	mA
Continuous load current (AC peak/DC)	I _O	-	-	100	mA
Ambient operating temperature	T _a	-20	-	65	°C

Engineering Data

LED forward current vs. Ambient temperature

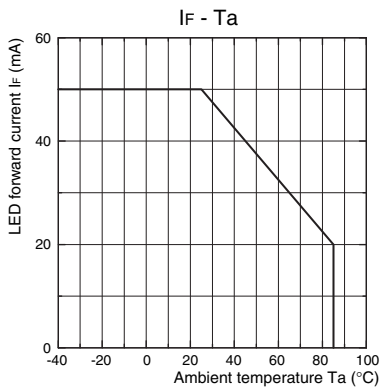

Continuous load current vs. Ambient temperature

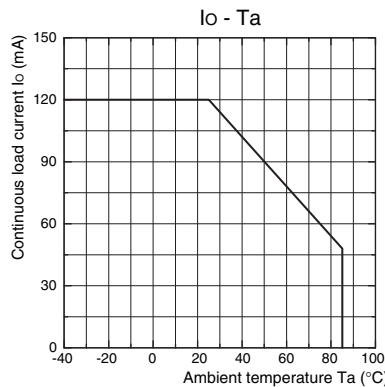

LED forward current vs. LED forward voltage

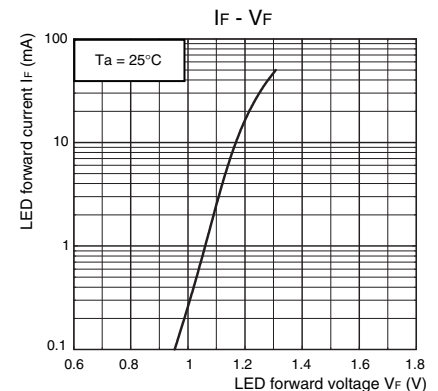

Continuous load current vs. On-state voltage

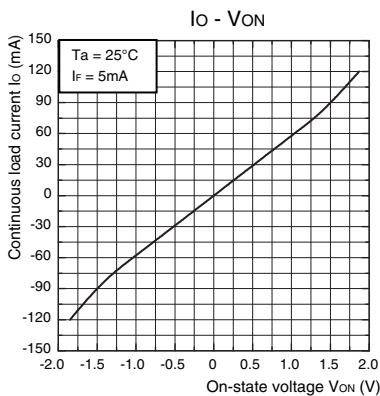

On-state resistance vs. Ambient temperature

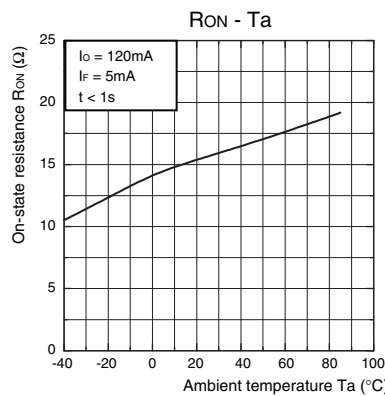

Trigger LED forward current vs. Ambient temperature

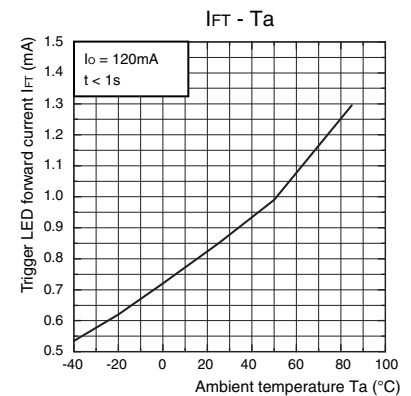

Turn ON, Turn OFF time vs. LED forward current

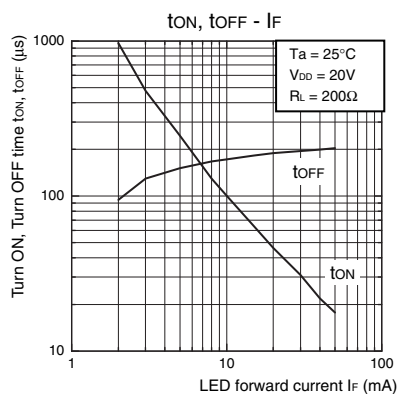

Turn ON, Turn OFF time vs. Ambient temperature

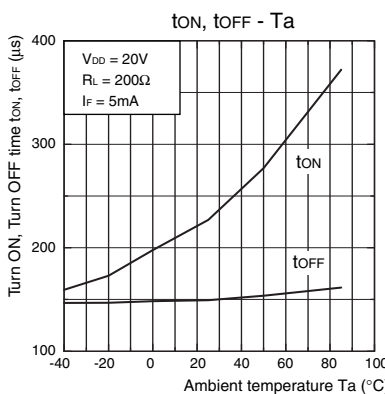

Current leakage vs. Ambient temperature

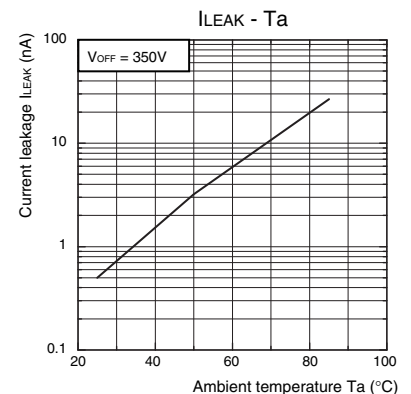

Safety Precautions

- Refer to "Common Precautions" for all G3VM models.

■ Appearance

DIP (Dual Inline Package)

DIP4

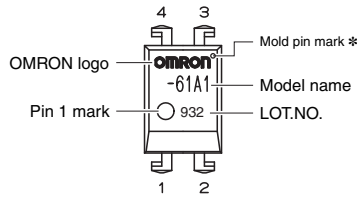

Note: The actual product is marked differently from the image shown here.

* The indentation in the corner diagonally opposite from the pin 1 mark is from a pin on the mold.

■ Dimensions

(Unit:mm)

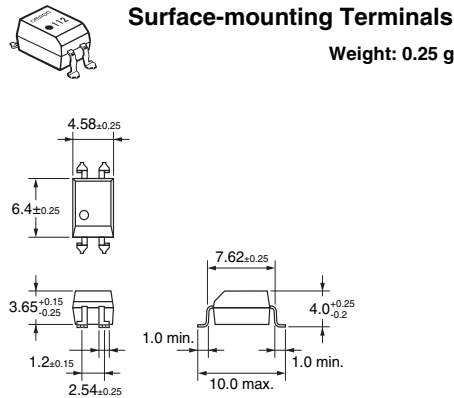
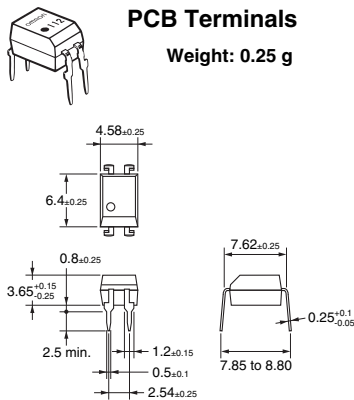

PCB Dimensions (BOTTOM VIEW)

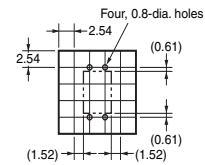

Actual Mounting Pad Dimensions

(Recommended Value, TOP VIEW)

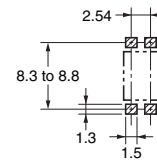

Note: The actual product is marked differently from the image shown here.

- Application examples provided in this document are for reference only. In actual applications, confirm equipment functions and safety before using the product.
- Consult your OMRON representative before using the product under conditions which are not described in the manual or applying the product to nuclear control systems, railroad systems, aviation systems, vehicles, combustion systems, medical equipment, amusement machines, safety equipment, and other systems or equipment that may have a serious influence on lives and property if used improperly. Make sure that the ratings and performance characteristics of the product provide a margin of safety for the system or equipment, and be sure to provide the system or equipment with double safety mechanisms.

Note: Do not use this document to operate the Unit.