



Chipsmall Limited consists of a professional team with an average of over 10 year of expertise in the distribution of electronic components. Based in Hongkong, we have already established firm and mutual-benefit business relationships with customers from,Europe,America and south Asia,supplying obsolete and hard-to-find components to meet their specific needs.

With the principle of “Quality Parts,Customers Priority,Honest Operation,and Considerate Service”,our business mainly focus on the distribution of electronic components. Line cards we deal with include Microchip,ALPS,ROHM,Xilinx,Pulse,ON,Everlight and Freescale. Main products comprise IC,Modules,Potentiometer,IC Socket,Relay,Connector.Our parts cover such applications as commercial,industrial, and automotives areas.

We are looking forward to setting up business relationship with you and hope to provide you with the best service and solution. Let us make a better world for our industry!



Contact us

Tel: +86-755-8981 8866 Fax: +86-755-8427 6832

Email & Skype: info@chipsmall.com Web: www.chipsmall.com

Address: A1208, Overseas Decoration Building, #122 Zhenhua RD., Futian, Shenzhen, China



MOS FET Relays

G3VM-354C/C1/F/F1

Analog-switching MOS FET Relay with DPST-NC Contacts. General-purpose models added.

- Switches minute analog signals.
- Switching AC and DC.
- General-purpose models (high ON resistance) added.
- RoHS Compliant.

Application Examples

- Electronic automatic exchange systems
- Security systems
- Datacom (modem) systems
- FA systems and Measurement devices

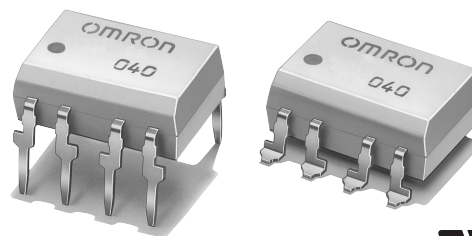

Note: The actual product is marked differently from the image shown here.

List of Models

Contact form	Terminals	Load voltage (peak value)	Model	Number per stick	Number per tape	
DPST-NC	PCB terminals	350 VAC	G3VM-354C	50	---	
			G3VM-354C1			
			G3VM-354F			
			G3VM-354F1			
	Surface-mounting terminals		G3VM-354F(TR)	---		1,500
			G3VM-354F1(TR)			

Dimensions

Note: All units are in millimeters unless otherwise indicated.

G3VM-354C/C1

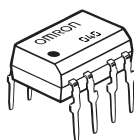

Note: The actual product is marked differently from the image shown here.

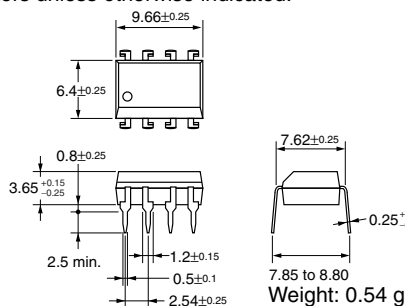

G3VM-354F/F1

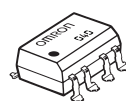

Note: The actual product is marked differently from the image shown here.

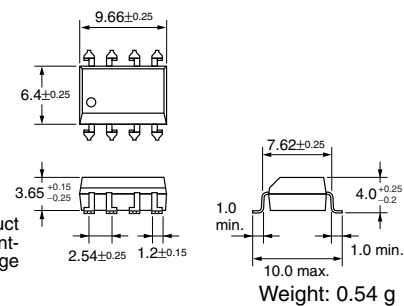

Terminal Arrangement/Internal Connections (Top View)

G3VM-354C/C1

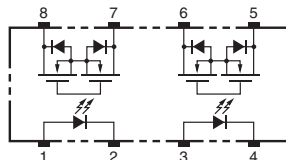

G3VM-354F/F1

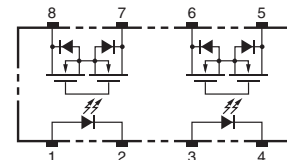

PCB Dimensions (Bottom View)

G3VM-354C/C1

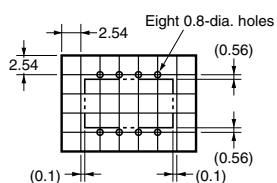

Actual Mounting Pad Dimensions (Recommended Value, Top View)

G3VM-354F/F1

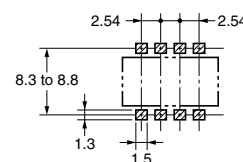

■ Absolute Maximum Ratings (Ta = 25°C)

Item		Symbol	Rating	Unit	Measurement conditions
Input	LED forward current	I_F	50	mA	
	Repetitive peak LED forward current	I_{FP}	1	A	100 μ s pulses, 100 pps
	LED forward current reduction rate	$\Delta I_F/^\circ\text{C}$	-0.5	mA/°C	Ta \geq 25°C
	LED reverse voltage	V_R	5	V	
	Connection temperature	T_j	125	°C	
Output	Load voltage (AC peak/DC)	V_{OFF}	350	V	
	Continuous load current (AC peak/DC)	I_O	150 (100)	mA	
	ON current reduction rate	$\Delta I_{ON}/^\circ\text{C}$	-1.5 (-1)	mA/°C	Ta \geq 25°C
	Connection temperature	T_j	125	°C	
Dielectric strength between input and output (See note 1.)		V_{I-O}	2,500	V_{rms}	AC for 1 min
Operating temperature		T_a	-40 to +85	°C	With no icing or condensation
Storage temperature		T_{stg}	-55 to +125	°C	With no icing or condensation
Soldering temperature (10 s)		---	260	°C	10 s

Note: 1. The dielectric strength between the input and output was checked by applying voltage between all pins as a group on the LED side and all pins as a group on the light-receiving side.

Values in parentheses are for the G3VM-354C1/F1

■ Electrical Characteristics (Ta = 25°C)

Item		Symbol	Minimum	Typical	Maximum	Unit	Measurement conditions
Input	LED forward voltage	V_F	1.0	1.15	1.3	V	$I_F = 10$ mA
	Reverse current	I_R	---	---	10	μ A	$V_R = 5$ V
	Capacity between terminals	C_T	---	30	---	pF	$V = 0, f = 1$ MHz
	Trigger LED forward current	I_{FT}	---	1	3	mA	$I_{OFF} = 10$ μ A
Output	Maximum resistance with output ON	R_{ON}	---	15 (30)	25 (50)	Ω	$I_O = 150$ mA
	Current leakage when the relay is open	I_{LEAK}	---	0.0105 (0.003)	1.0	μ A	$I_F = 5$ mA, $V_{OFF} = 350$ V
	Capacity between terminals	C_{OFF}	---	85 (30)	---	pF	$V = 0, f = 1$ MHz, $I_F = 5$ mA
Capacity between I/O terminals		C_{I-O}	---	0.8	---	pF	$f = 1$ MHz, $V_s = 0$ V
Insulation resistance		R_{I-O}	1,000	---	---	M Ω	$V_{I-O} = 500$ VDC, $R_{OH} \leq 60\%$
Turn-ON time		t_{ON}	---	0.1 (0.25)	1.0 (0.5)	ms	$I_F = 5$ mA, $R_L = 200$ Ω , $V_{DD} = 20$ V (See note 2.)
Turn-OFF time		t_{OFF}	---	1.0 (0.5)	3.0(0.1)	ms	

Values in parentheses are for the G3VM-354C1/F1

■ Recommended Operating Conditions

Use the G3VM under the following conditions so that the Relay will operate properly.

Item	Symbol	Minimum	Typical	Maximum	Unit
Load voltage (AC peak/DC)	V_{DD}	---	---	280	V
Operating LED forward current	I_F	5	---	25	mA
Continuous load current (AC peak/DC)	I_O	---	---	150 (100)	mA
Operating temperature	T_a	-20	---	65	°C

Values in parentheses are for the G3VM-354C1/F1

Note: 2. Turn-ON and Turn-OFF Times

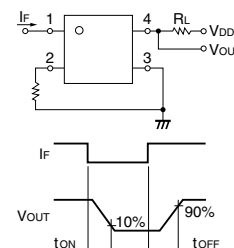

■ Engineering Data

G3VM-354C/F

LED forward current vs. Ambient temperature
IF - Ta

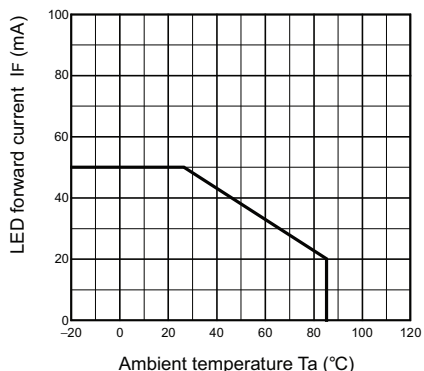

Continuous load current vs. Ambient temperature
IO - Ta

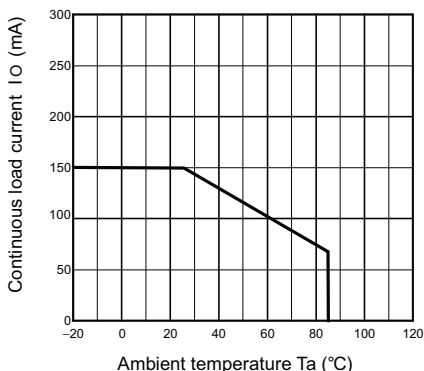

LED forward current vs. LED forward voltage
IF - VF

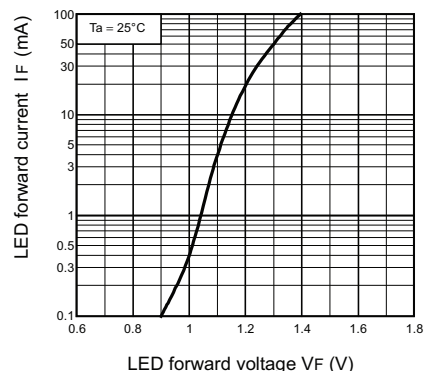

Continuous load current vs. On-state voltage
IO - VON

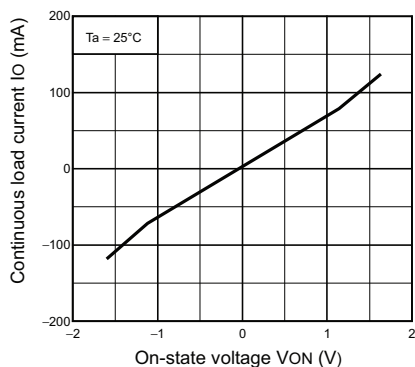

On-state resistance vs. Ambient temperature
RON - Ta

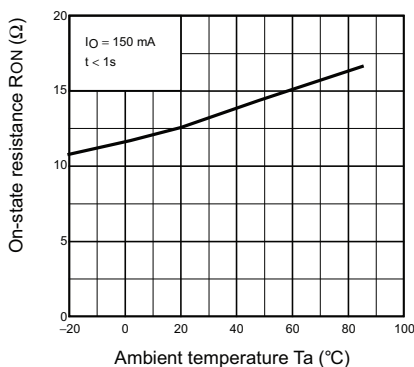

Trigger LED forward current vs. Ambient temperature
IFC - Ta

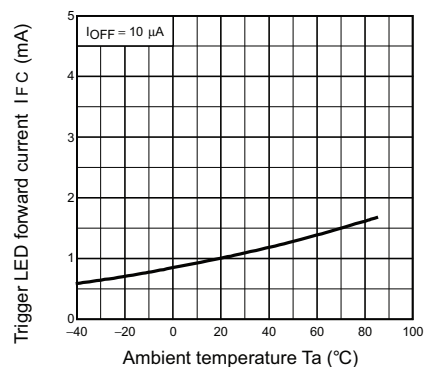

Turn ON, Turn OFF time vs. LED forward current
tON, tOFF - IF

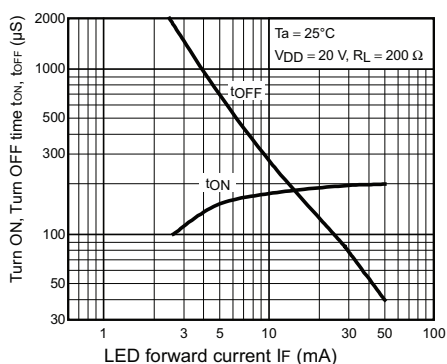

Turn ON, Turn OFF time vs. Ambient temperature
tON, tOFF - Ta

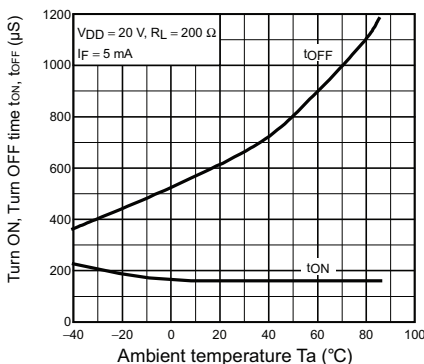

Current leakage vs. Ambient temperature
ILEAK - Ta

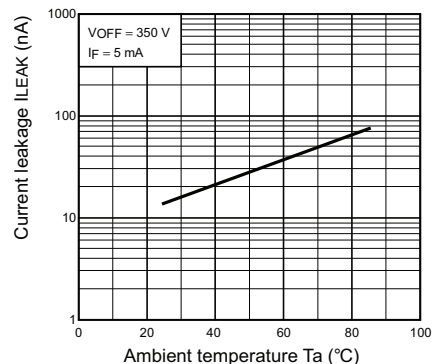

■ Engineering Data

G3VM-354C1/F1

LED forward current vs. Ambient temperature
IF - Ta

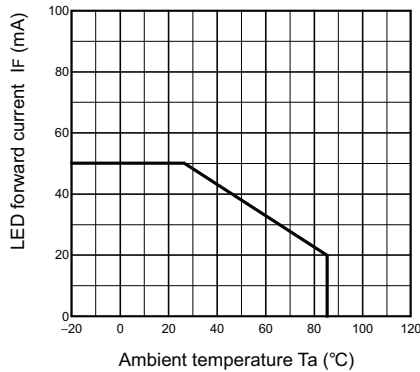

Continuous load current vs. Ambient temperature
IO - Ta

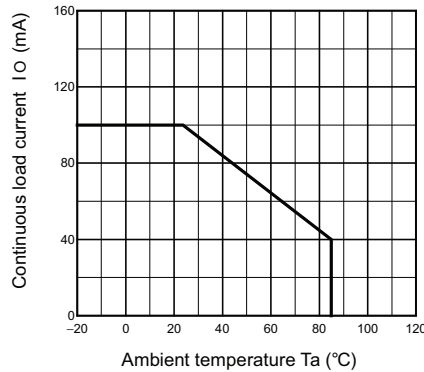

LED forward current vs. LED forward voltage
IF - VF

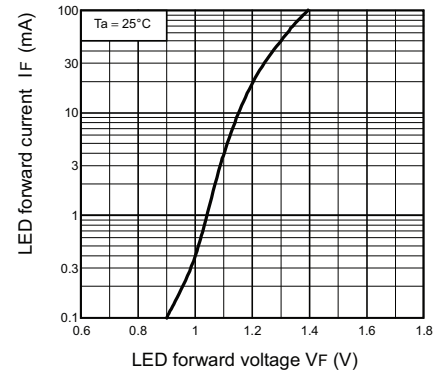

Continuous load current vs. On-state voltage
IO - VON

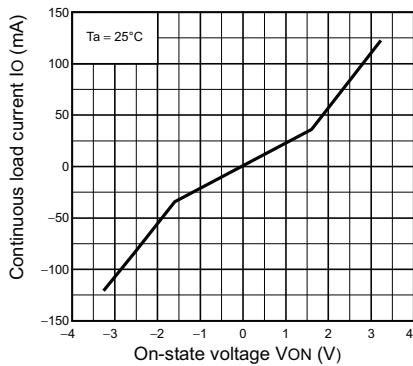

On-state resistance vs. Ambient temperature
RON - Ta

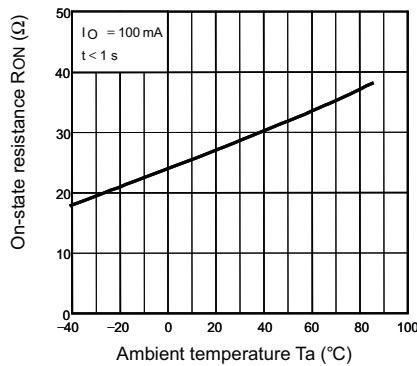

Trigger LED forward current vs. Ambient temperature
IFC - Ta

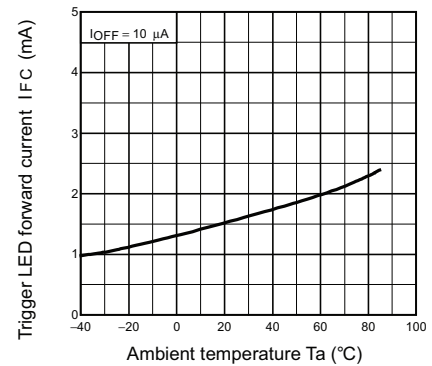

Turn ON, Turn OFF time vs. LED forward current
tON, tOFF - IF

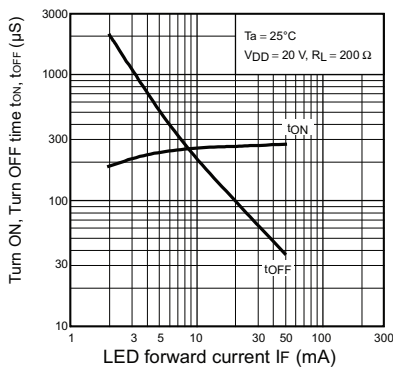

Turn ON, Turn OFF time vs. Ambient temperature
tON, tOFF - Ta

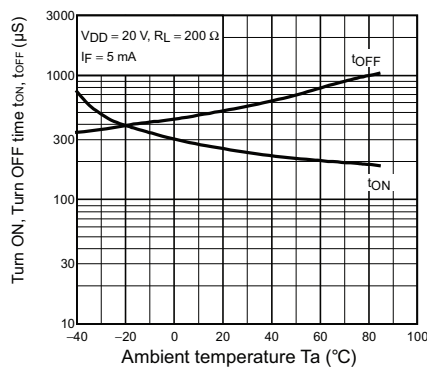

Current leakage vs. Ambient temperature
ILEAK - Ta

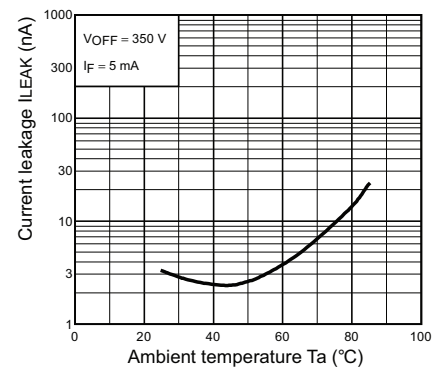

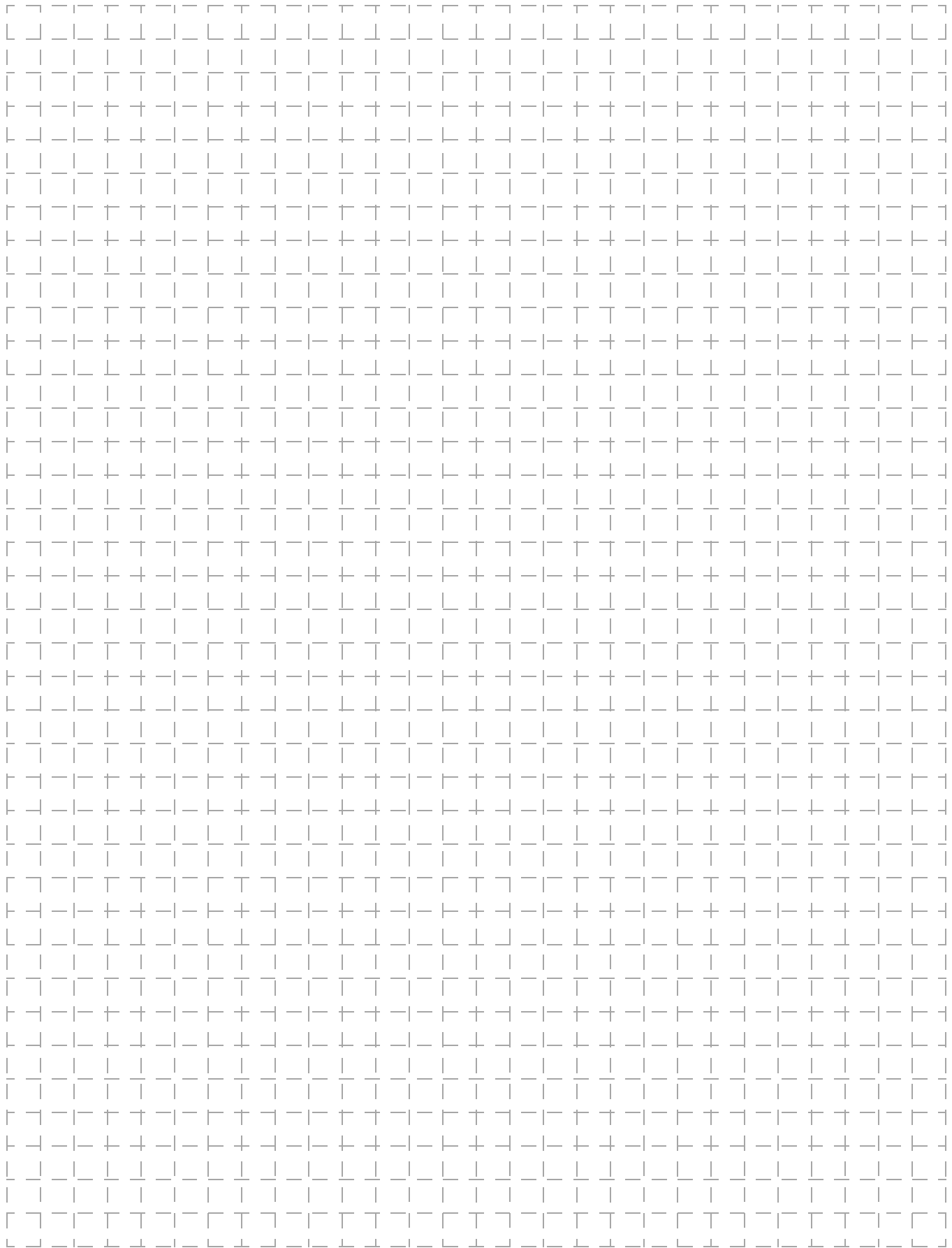

All sales are subject to Omron Electronic Components LLC standard terms and conditions of sale, which can be found at http://www.components.omron.com/components/web/webfiles.nsf/sales_terms.html

ALL DIMENSIONS SHOWN ARE IN MILLIMETERS.
To convert millimeters into inches, multiply by 0.03937. To convert grams into ounces, multiply by 0.03527.

OMRON[®]

**OMRON ELECTRONIC
COMPONENTS LLC**

55 E. Commerce Drive, Suite B
Schaumburg, IL 60173

847-882-2288

OMRON ON-LINE

Global - <http://www.omron.com>

USA - <http://www.components.omron.com>

Cat. No. X302-E-1

12/10

Specifications subject to change without notice

Printed in USA