



Chipsmall Limited consists of a professional team with an average of over 10 year of expertise in the distribution of electronic components. Based in Hongkong, we have already established firm and mutual-benefit business relationships with customers from,Europe,America and south Asia,supplying obsolete and hard-to-find components to meet their specific needs.

With the principle of “Quality Parts,Customers Priority,Honest Operation,and Considerate Service”,our business mainly focus on the distribution of electronic components. Line cards we deal with include Microchip,ALPS,ROHM,Xilinx,Pulse,ON,Everlight and Freescale. Main products comprise IC,Modules,Potentiometer,IC Socket,Relay,Connector.Our parts cover such applications as commercial,industrial, and automotives areas.

We are looking forward to setting up business relationship with you and hope to provide you with the best service and solution. Let us make a better world for our industry!



## Contact us

Tel: +86-755-8981 8866 Fax: +86-755-8427 6832

Email & Skype: info@chipsmall.com Web: www.chipsmall.com

Address: A1208, Overseas Decoration Building, #122 Zhenhua RD., Futian, Shenzhen, China



# G3VM-41BR/ER

MOS FET Relays

Higher power, 3.5-A switching with a 40-V load voltage, DIP package.

Low 30 mΩ ON Resistance.

- Continuous load current of 3.5 A. (Connection C: 7 A)
- Switches minute analog signals.
- Dielectric strength of 2,500 Vrms between I/O.

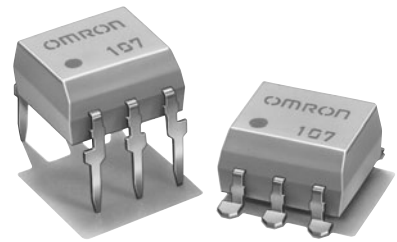

**NEW**

Note: The actual product is marked differently from the image shown here.

## Terminal Arrangement/Internal Connections

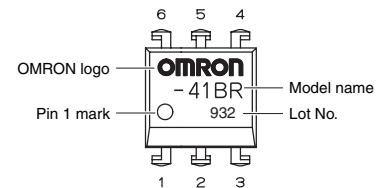
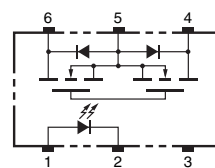

Note: The actual product is marked differently from the image shown here.

RoHS compliant

## Application Examples

- Communication equipment
- Test & Measurement equipment
- Security equipment
- Factory Automation equipment
- Power circuit

## List of Models

Package type	Contact form	Terminals	Load voltage (peak value) *	Model	Minimum package quantity	
					Number per stick	Number per tape and reel
DIP6	1a (SPST-NO)	PCB terminals	40 V	G3VM-41BR	50	---
		Surface-mounting terminals		G3VM-41ER		
				G3VM-41ER (TR)	---	1,500

\* The AC peak and DC value are given for the load voltage.

## Absolute Maximum Ratings (Ta = 25°C)

Item	Symbol	Rating	Unit	Measurement conditions	
Input	LED forward current	IF	30	mA	
	Repetitive peak LED forward current	IFP	1	A	100 μs pulses, 100 pps
	LED forward current reduction rate	ΔIF/°C	-0.3	mA/°C	Ta ≥ 25°C
	LED reverse voltage	VR	5	V	
Connection temperature	TJ	125	°C		
Output	Load voltage (AC peak/DC)	V <sub>OFF</sub>	40	V	
	Continuous load current	Io	3.5	A	Connection A: AC peak/DC Connection B and C: DC
			3.5		
			7		
	ON current reduction rate	ΔIo/°C	-35	mA/°C	Ta ≥ 25°C
			-35		
			-70		
Pulse ON current	I <sub>op</sub>	10.5	A	t = 100 ms, Duty = 1/10	
Connection temperature	TJ	125	°C		
Dielectric strength between I/O (See note 1.)	V <sub>I-O</sub>	2500	Vrms	AC for 1 min	
Operating temperature	Ta	-40 to +85	°C	With no icing or condensation	
Storage temperature	T <sub>stg</sub>	-55 to +125	°C	With no icing or condensation	
Soldering temperature	---	260	°C	10 s	

Note: 1. The dielectric strength between the input and output was checked by applying voltage between all pins as a group on the LED side and all pins as a group on the light-receiving side.

### Connection Diagram

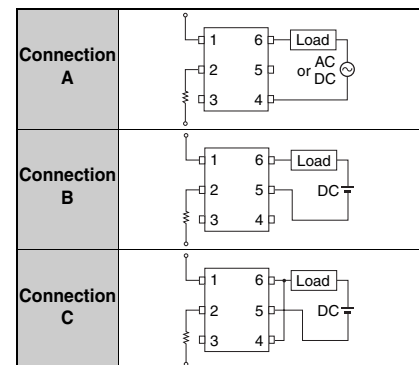

## Electrical Characteristics (Ta = 25°C)

Item	Symbol	Minimum	Typical	Maximum	Unit	Measurement conditions		
Input	LED forward voltage	V <sub>F</sub>	1.18	1.33	1.48	V	I <sub>F</sub> = 10 mA	
	Reverse current	I <sub>R</sub>	---	---	10	μA	V <sub>R</sub> = 5 V	
	Capacity between terminals	C <sub>T</sub>	---	70	---	pF	V = 0, f = 1 MHz	
Output	Trigger LED forward current	I <sub>FT</sub>	---	0.5	3	mA	I <sub>o</sub> = 1 A	
	Maximum resistance with output ON	R <sub>ON</sub>	Connection A	---	30	60	mΩ	I <sub>F</sub> = 5 mA, I <sub>o</sub> = 2 A, t < 1 s
			Connection B	---	15	---	mΩ	I <sub>F</sub> = 5 mA, I <sub>o</sub> = 2 A, t < 1 s
			Connection C	---	8	---	mΩ	I <sub>F</sub> = 5 mA, I <sub>o</sub> = 4 A, t < 1 s
	Current leakage when the relay is open	I <sub>LEAK</sub>	---	---	1.0	μA	V <sub>OFF</sub> = 40 V	
	Capacity between terminals	C <sub>OFF</sub>	---	1000	---	pF	V = 0, f = 1 MHz	
Capacity between I/O terminals	C <sub>I-O</sub>	---	0.8	---	pF	f = 1 MHz, V <sub>s</sub> = 0 V		
Insulation resistance between I/O terminals	R <sub>I-O</sub>	1000	---	---	MΩ	V <sub>I-O</sub> = 500 VDC, R <sub>oH</sub> ≤ 60%		
Turn-ON time	t <sub>ON</sub>	---	2	5	ms	I <sub>F</sub> = 5 mA, R <sub>L</sub> = 200 Ω, V <sub>DD</sub> = 20 V (See note 2.)		
Turn-OFF time	t <sub>OFF</sub>	---	0.1	1	ms			

Note: 2. Turn-ON and Turn-OFF Times

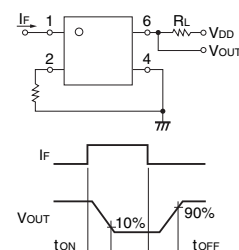

## Recommended Operating Conditions

Use the G3VM under the following conditions so that the Relay will operate properly.

Item	Symbol	Minimum	Typical	Maximum	Unit
Load voltage (AC peak/DC)	$V_{DD}$	---	---	32	V
Operating LED forward current	$I_F$	5	10	25	mA
Continuous load current (AC peak/DC)	$I_O$	---	---	3.5	A
Operating temperature	$T_a$	-20	---	65	°C

## Engineering Data

LED forward current vs. Ambient temperature

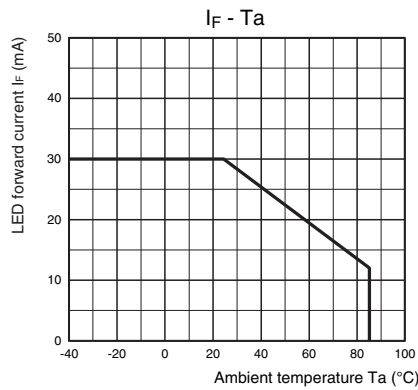

Continuous load current vs. Ambient temperature

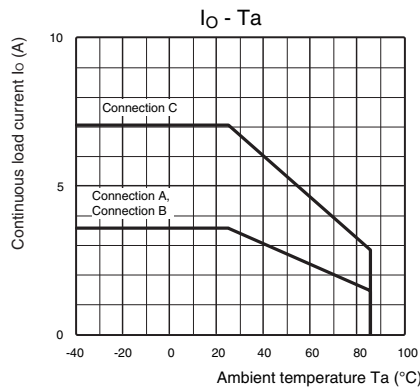

LED forward current vs. LED forward voltage

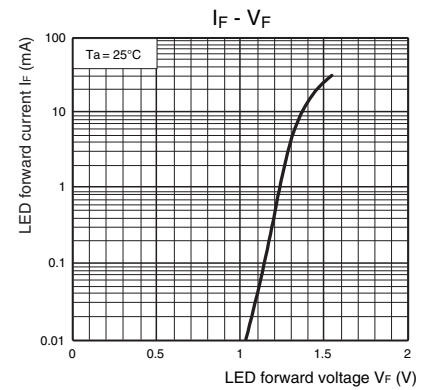

Continuous load current vs. On-state voltage

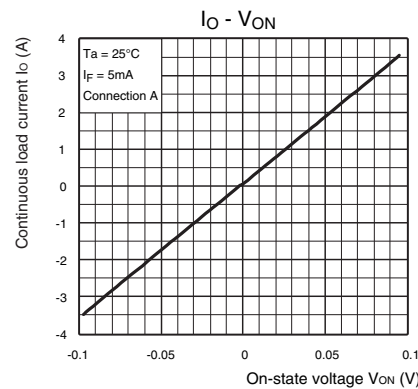

On-state resistance vs. Ambient temperature

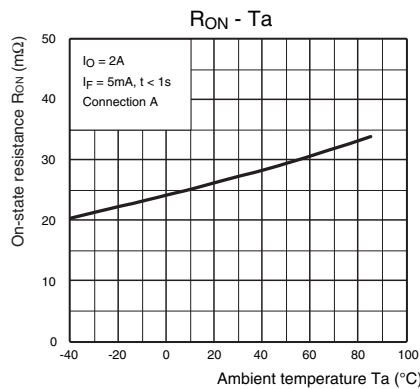

Trigger LED forward current vs. Ambient temperature

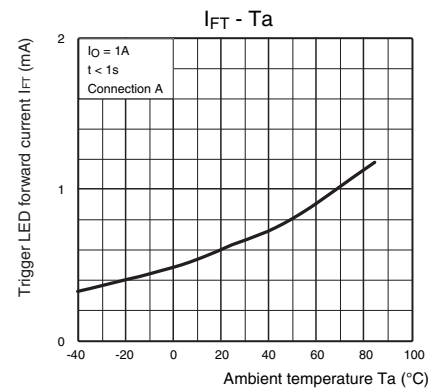

Turn ON, Turn OFF time vs. LED forward current

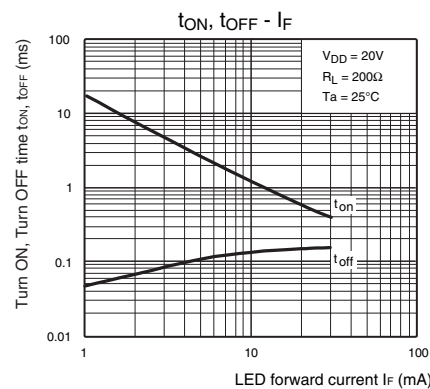

Turn ON, Turn OFF time vs. Ambient temperature

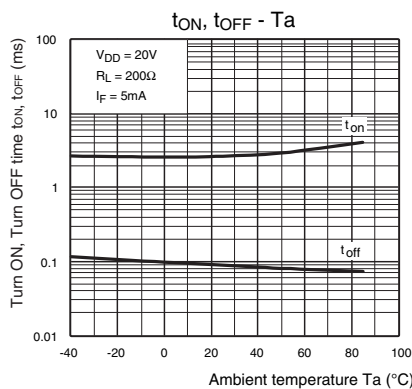

Current leakage vs. Ambient temperature

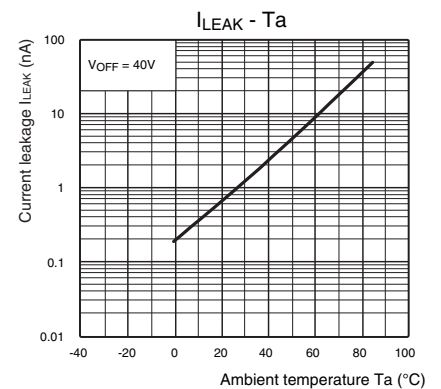

## Safety Precautions

- Refer to "Common Precautions" for all G3VM models.

## ■ Appearance

### DIP (Dual Inline Package)

DIP6

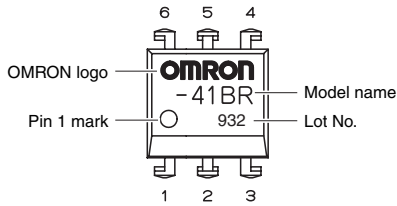

**Note:** The actual product is marked differently from the image shown here.

## ■ Dimensions

(Unit: mm)

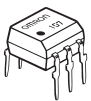

### PCB Terminals

Weight: 0.4 g

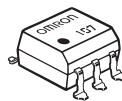
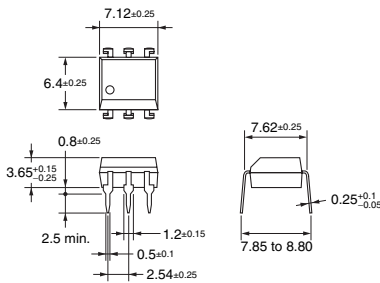

### Surface-mounting Terminals

Weight: 0.4 g

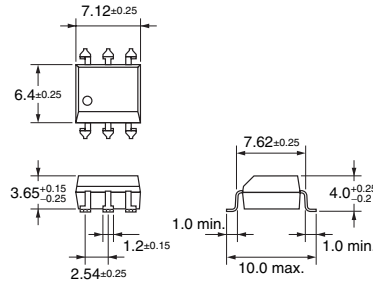

### PCB Dimensions (Bottom View)

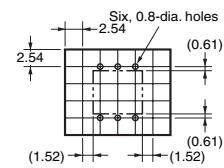

### Actual Mounting Pad Dimensions

(Recommended Value, Top View)

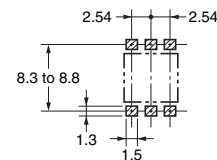

**Note:** The actual product is marked differently from the image shown here.

- Application examples provided in this document are for reference only. In actual applications, confirm equipment functions and safety before using the product.
- Consult your OMRON representative before using the product under conditions which are not described in the manual or applying the product to nuclear control systems, railroad systems, aviation systems, vehicles, combustion systems, medical equipment, amusement machines, safety equipment, and other systems or equipment that may have a serious influence on lives and property if used improperly. Make sure that the ratings and performance characteristics of the product provide a margin of safety for the system or equipment, and be sure to provide the system or equipment with double safety mechanisms.

**Note:** Do not use this document to operate the Unit.