



Chipsmall Limited consists of a professional team with an average of over 10 year of expertise in the distribution of electronic components. Based in Hongkong, we have already established firm and mutual-benefit business relationships with customers from,Europe,America and south Asia,supplying obsolete and hard-to-find components to meet their specific needs.

With the principle of “Quality Parts,Customers Priority,Honest Operation,and Considerate Service”,our business mainly focus on the distribution of electronic components. Line cards we deal with include Microchip,ALPS,ROHM,Xilinx,Pulse,ON,Everlight and Freescale. Main products comprise IC,Modules,Potentiometer,IC Socket,Relay,Connector.Our parts cover such applications as commercial,industrial, and automotives areas.

We are looking forward to setting up business relationship with you and hope to provide you with the best service and solution. Let us make a better world for our industry!



Contact us

Tel: +86-755-8981 8866 Fax: +86-755-8427 6832

Email & Skype: info@chipsmall.com Web: www.chipsmall.com

Address: A1208, Overseas Decoration Building, #122 Zhenhua RD., Futian, Shenzhen, China



G3VM-41HR

MOS FET Relays

Higher power, 2.5-A switching with a 40-V load voltage, SOP package. Low 30-mΩ ON Resistance.

- Continuous load current of 2.5 A. (Connection C: 5 A)

RoHS compliant

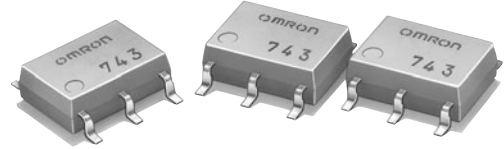

NEW

Note: The actual product is marked differently from the image shown here.

Application Examples

- Communication equipment
- Test & Measurement equipment
- Data loggers
- Industrial equipment

Terminal Arrangement/Internal Connections

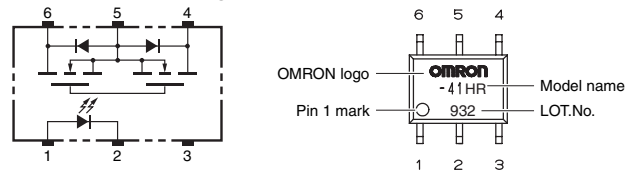

Note: The actual product is marked differently from the image shown here.

List of Models

Package type	Contact form	Terminals	Load voltage (peak value) *	Model	Minimum package quantity	
					Number per tube	Number per tape and reel
SOP6	1a (SPST-NO)	Surface-mounting Terminals	40 V	G3VM-41HR	75	-
				G3VM-41HR (TR)	-	2,500

* The AC peak and DC value are given for the load voltage.

Absolute Maximum Ratings (Ta = 25°C)

Item	Symbol	Rating	Unit	Measurement conditions	
Input	LED forward current	I _F	30	mA	
	LED forward current reduction rate	ΔI _F /°C	-0.3	mA/°C	Ta ≥ 25°C
	LED reverse voltage	V _R	5	V	
	Connection temperature	T _J	125	°C	
Output	Load voltage (AC peak/DC)	V _{OFF}	40	V	
	Continuous load current	Connection A	2.5	A	Connection A: AC peak/DC Connection B and C: DC
		Connection B	2.5		
		Connection C	5		
	ON current reduction rate	Connection A	-33.3	mA/°C	Ta ≥ 50°C
		Connection B	-33.3		
Connection C		-66.7			
Pulse ON current	I _{OP}	7.5	A	t = 100 ms	
Connection temperature	T _J	125	°C		
Dielectric strength between I/O (See note 1.)	V _{I-O}	1500	V _{rms}	AC for 1 min	
Ambient operating temperature	T _a	-40 to +85	°C	With no icing or condensation	
Ambient storage temperature	T _{stg}	-55 to +125	°C	With no icing or condensation	
Soldering temperature	-	260	°C	10 s	

Note: 1. The dielectric strength between the input and output was checked by applying voltage between all pins as a group on the LED side and all pins as a group on the light-receiving side.

Connection Diagram

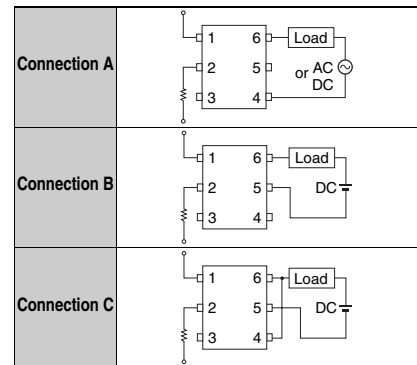

Electrical Characteristics (Ta = 25°C)

Item	Symbol	Minimum	Typical	Maximum	Unit	Measurement conditions	
Input	LED forward voltage	V _F	1.18	1.33	1.48	V	I _F = 10 mA
	Reverse current	I _R	-	-	10	μA	V _R = 5 V
	Capacity between terminals	C _T	-	70	-	pF	V = 0, f = 1 MHz
	Trigger LED forward current	I _{FT}	-	0.4	3	mA	I _O = 100 mA
Output	Maximum resistance with output ON	Connection A	-	0.03	0.06	Ω	I _F = 5 mA, I _O = 2 A, t < 1 s
		Connection B	-	0.015	0.03	Ω	I _F = 5 mA, I _O = 2 A, t < 1 s
		Connection C	-	0.008	-	Ω	I _F = 5 mA, I _O = 4 A, t < 1 s
Current leakage when the relay is open	I _{LEAK}	-	-	10	nA	V _{OFF} = 40 V	
Capacity between terminals	C _{OFF}	-	1000	-	pF	V = 0, f = 1 MHz	
Capacity between I/O terminals	C _{I-O}	-	0.8	-	pF	f = 1 MHz, V _s = 0 V	
Insulation resistance between I/O terminals	R _{I-O}	1000	-	-	MΩ	V _{I-O} = 500 VDC, RoH ≤ 60 %	
Turn-ON time	t _{ON}	-	1.0	5.0	ms	I _F = 5 mA, R _L = 200 Ω, V _{DD} = 20 V (See note 2.)	
Turn-OFF time	t _{OFF}	-	0.15	1.0	ms		

Note: 2. Turn-ON and Turn-OFF Times

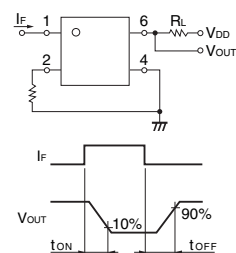

Recommended Operating Conditions

Use the G3VM under the following conditions so that the Relay will operate properly.

Item	Symbol	Minimum	Typical	Maximum	Unit
Load voltage (AC peak/DC)	V_{DD}	-	-	40	V
Operating LED forward current	I_F	5	7.5	20	mA
Continuous load current (AC peak/DC)	I_o	-	-	2	A
Ambient operating temperature	T_a	-20	-	65	°C

Engineering Data

LED forward current vs. Ambient temperature

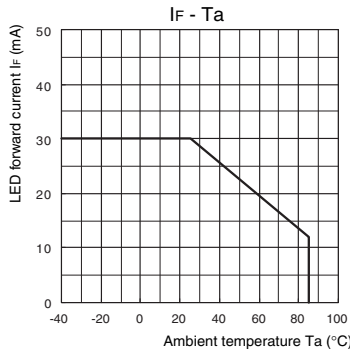

Continuous load current vs. Ambient temperature

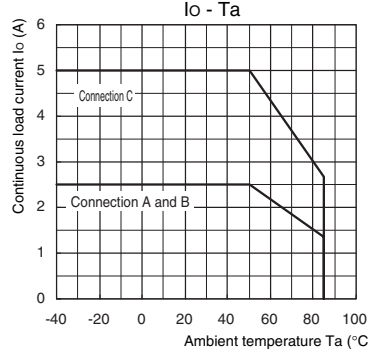

LED forward current vs. LED forward voltage

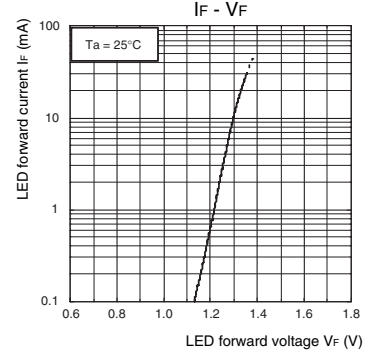

Continuous load current vs. On-state voltage

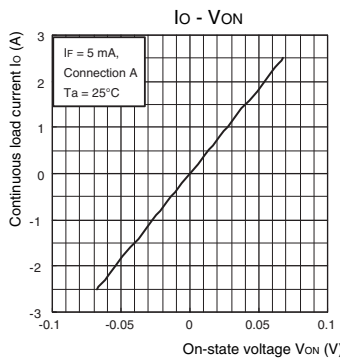

On-state resistance vs. Ambient temperature

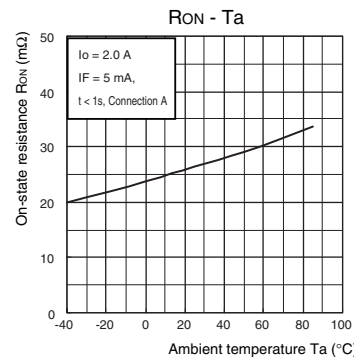

Trigger LED forward current vs. Ambient temperature

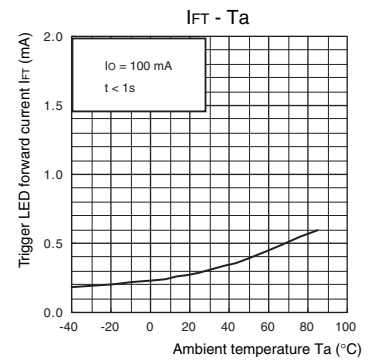

Turn ON, Turn OFF time vs. LED forward current

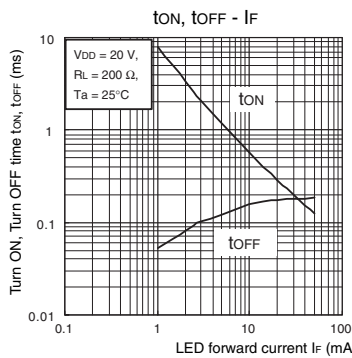

Turn ON, Turn OFF time vs. Ambient temperature

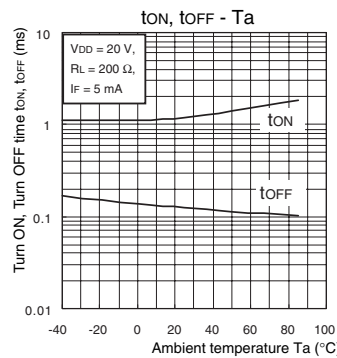

Current leakage vs. Load voltage

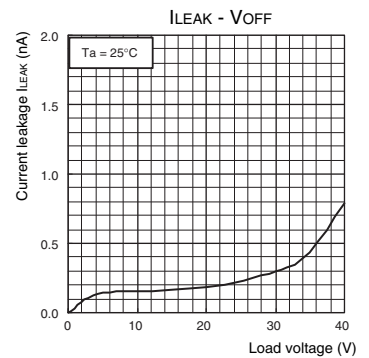

Output terminal capacitance vs. Load voltage

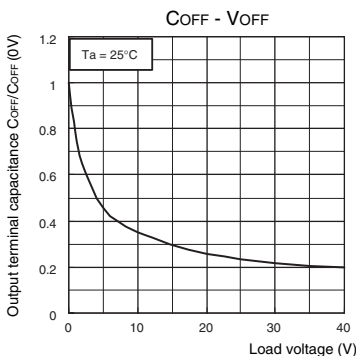

Safety Precautions

- Refer to "Common Precautions" for all G3VM models.

■ Appearance

SOP (Small Outline Package) SOP6

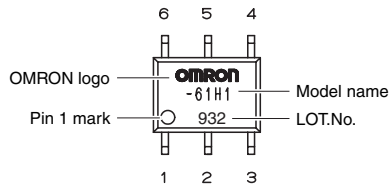

Note: The actual product is marked differently from the image shown here.

■ Dimensions

(Unit: mm)

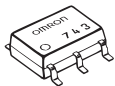

Surface-mounting Terminals

Weight: 0.13 g

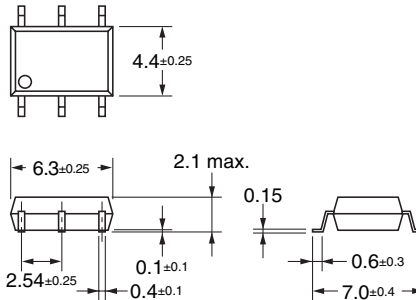

Actual Mounting Pad Dimensions

(Recommended Value, TOP VIEW)

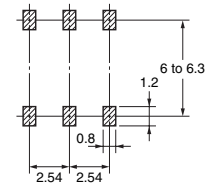

Note: The actual product is marked differently from the image shown here.

- Application examples provided in this document are for reference only. In actual applications, confirm equipment functions and safety before using the product.
- Consult your OMRON representative before using the product under conditions which are not described in the manual or applying the product to nuclear control systems, railroad systems, aviation systems, vehicles, combustion systems, medical equipment, amusement machines, safety equipment, and other systems or equipment that may have a serious influence on lives and property if used improperly. Make sure that the ratings and performance characteristics of the product provide a margin of safety for the system or equipment, and be sure to provide the system or equipment with double safety mechanisms.

Note: Do not use this document to operate the Unit.

OMRON Corporation

ELECTRONIC AND MECHANICAL COMPONENTS COMPANY

Contact: www.omron.com/ecb

Cat. No. **K174-E1-01**
0412(0412)(O)