



Chipsmall Limited consists of a professional team with an average of over 10 year of expertise in the distribution of electronic components. Based in Hongkong, we have already established firm and mutual-benefit business relationships with customers from,Europe,America and south Asia,supplying obsolete and hard-to-find components to meet their specific needs.

With the principle of “Quality Parts,Customers Priority,Honest Operation,and Considerate Service”,our business mainly focus on the distribution of electronic components. Line cards we deal with include Microchip,ALPS,ROHM,Xilinx,Pulse,ON,Everlight and Freescale. Main products comprise IC,Modules,Potentiometer,IC Socket,Relay,Connector.Our parts cover such applications as commercial,industrial, and automotives areas.

We are looking forward to setting up business relationship with you and hope to provide you with the best service and solution. Let us make a better world for our industry!



## Contact us

Tel: +86-755-8981 8866 Fax: +86-755-8427 6832

Email & Skype: info@chipsmall.com Web: www.chipsmall.com

Address: A1208, Overseas Decoration Building, #122 Zhenhua RD., Futian, Shenzhen, China



This document is the property of Amphenol Corporation and is delivered on the express condition that it is not to be disclosed, reproduced or used, in whole or in part, for manufacture or sale by anyone other than Amphenol Corporation without its prior consent, and that no right is granted to disclose or to use any information in this document.

The marking on this product doesn't contain environmental hazardous material and must follow one or more specifications per Material Specification 55-00259 for Sony GP compliant or per directive 2011/65/EC for RoHS compliant or per IEC 61249-2-21 for Halogen Free compliant.

**FOR REFERENCE ONLY**

REVISIONS				
SYM	ECN No.	DESCRIPTION	DATE	BY
AX1		UNAPPROVAL REVISION	02/25/2015	Sondra Sang
A 2		ADD CONTACT PLATING OPTION	05/28/2015	Sondra Sang
AX3		ADD 64 POS. IN THE DIM. TABLE	06/15/2015	Sondra Sang
AX4		MODIFIED PINS	07/20/2015	Sondra Sang
A 5		ADD 20 POS. IN THE DIM. TABLE	08/14/2015	Sondra Sang

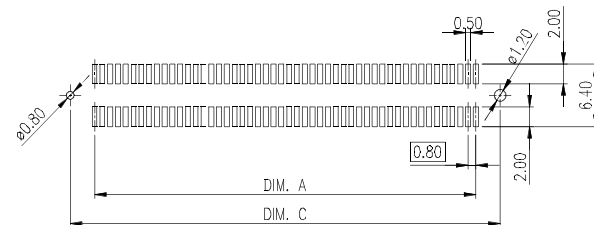
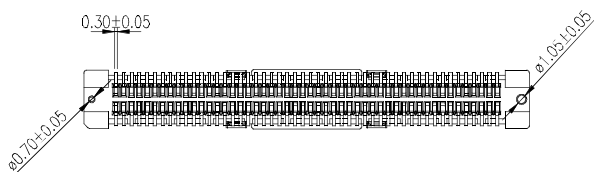
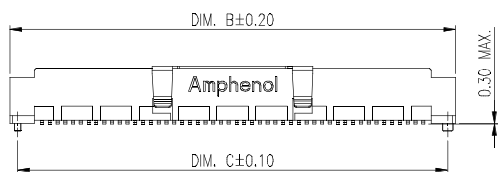
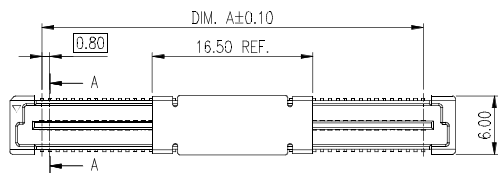

RECOMMENDED PCB LAYOUT- TOP VIEW  
(GENERAL TOLERANCES: ±0.05)

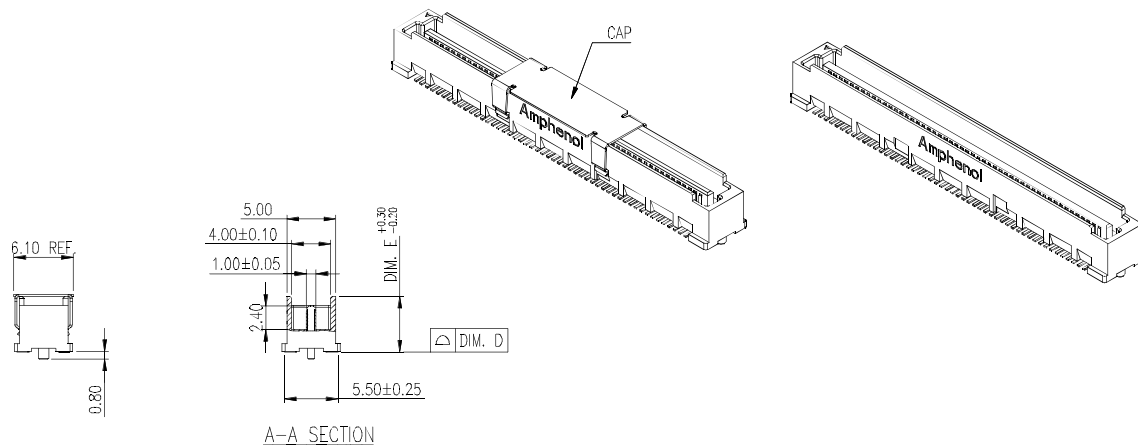

PART NUMBER:  
G832MB 1 X XXX X 2 X HR

- |              |                         |                                 |            |                       |           |           |           |           |                |                 |                        |                         |                           |                |               |              |              |             |
|--------------|-------------------------|---------------------------------|------------|-----------------------|-----------|-----------|-----------|-----------|----------------|-----------------|------------------------|-------------------------|---------------------------|----------------|---------------|--------------|--------------|-------------|
| STYLE OPTION | 1: STRAIGHT, LCP- BLACK | 3: STRAIGHT, LCP- NATURAL WHITE | NO OF POS. | CONN. HEIGHT (DIM. E) | 2: 4.70mm | 3: 5.70mm | 4: 6.70mm | 5: 7.70mm | PACKAGE OPTION | 1: TUBE PACKING | 2: T&R PACKING, W/ CAP | 3: T&R PACKING, W/O CAP | 4: T&R PACKING, W/O MYLAR | CONTACT FINISH | 0: GOLD FLASH | 1: 15μ" GOLD | 2: 30μ" GOLD | 3: 8μ" GOLD |
|--------------|-------------------------|---------------------------------|------------|-----------------------|-----------|-----------|-----------|-----------|----------------|-----------------|------------------------|-------------------------|---------------------------|----------------|---------------|--------------|--------------|-------------|

POS.	DIM. A	DIM. B	DIM. C	DIM. D
200	79.20	85.80	84.20	0.20 MAX.
180	71.20	77.80	76.20	0.15 MAX.
160	63.20	69.80	68.20	
140	55.20	61.80	60.20	0.12 MAX.
120	47.20	53.80	52.20	
100	39.20	45.80	44.20	0.10 MAX.
80	31.20	37.80	36.20	
64	24.80	31.40	29.80	0.10 MAX.
60	23.20	29.80	28.20	
40	15.20	21.80	20.20	0.10 MAX.
20	7.20	13.80	12.20	
POS.	DIM. A	DIM. B	DIM. C	DIM. D

NOTES:

- HOUSING: HIGH TEMPERATURE THERMOPLASTIC, UL 94V-0, COLOR- OPTIONAL
- CONTACT: COPPER ALLOY, 0.15mm THICKNESS, SELECTIVE GOLD PLATED ON CONTACT AREA, 100μ" MIN. MATTE TIN PLATED ON SOLDERING TAIL, 50μ" MIN. NICKEL UNDER-PLATED OVERALL
- CAP: STAINLESS STEEL, 0.20mm THICKNESS
- THIS PRODUCT DOESN'T CONTAIN ENVIRONMENTAL HAZARDOUS MATERIALS PER R DIRECTIVE 2011/65/EC FOR RoHS AND PER IEC 61249-2-21 FOR HALOGEN FREE COMPLIANT.





TOLERANCE	APPROVALS	DATE	TITLE		UNIT		SIZE	PART No.
X. X.X ±0.30 X.XX ±0.20 X.XXX ±0.10	DRAWN <b>Sondra Sang</b>	08/14/2015	BOARD TO BOARD CONN. 0.80mm PITCH PLUG		mm		A3	G832MB 1X XXX XX2X HR
	CHECKED <b>Chenny Yeh</b>	08/14/2015			NA		1 OF 1	G832MB1XXXXXX2XHR
ANGULAR ±1°	APPROVED <b>Hank Hsu</b>	08/14/2015			SCALE			REV. AX5
UNLESS OTHERWISE SPECIFIED	DWG TYPE CUST DWG	PROJECT CODE TXXX						

This document is the property of Amphenol Corporation and is delivered on the express condition that it not be disclosed, reproduced or used, in whole or in part, for manufacture or sale by anyone other than Amphenol Corporation without its prior consent, and that no right is granted to disclose or to use any information in this document.

The marking on this product doesn't contain environmental hazardous material and must follow one or more specifications per Material Specification 55-00259 for Sony GP compliant or per directive 2011/65/EC for RoHS compliant or per IEC 61249-2-21 for Halogen Free compliant.

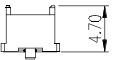
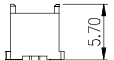
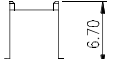
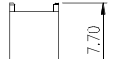
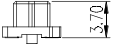
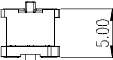
**FOR REFERENCE ONLY**

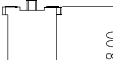
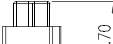
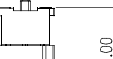
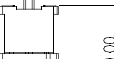
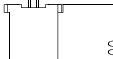
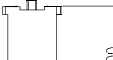
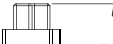
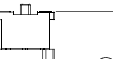
REVISIONS				
SYM	ECN No.	DESCRIPTION	DATE	BY
AX1		UNAPPROVAL REVISION	02/25/2015	Sondra Sang
A 2		ADD CONTACT PLATING OPTION	05/28/2015	Sondra Sang
AX3		ADD 64 POS. IN THE DIM. TABLE	06/15/2015	Sondra Sang
AX4		MODIFIED PINS	07/20/2015	Sondra Sang
A 5		ADD 20 POS. IN THE DIM. TABLE	08/14/2015	Sondra Sang

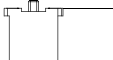
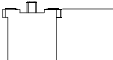
CONNECTOR STYLE AND MATING HEIGHT		PLUG			
					
		G832MB 1X XXX 2X2X HR	G832MB 1X XXX 3X2X HR	G832MB 1X XXX 4X2X HR	G832MB 1X XXX 5X2X HR
RECEPTACLE					
	G832MB 0X XXX 1X2X HR				
					
	G832MB 0X XXX 5X2X HR				
					
G832MB 0X XXX 6X2X HR					

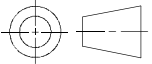

TOLERANCE	APPROVALS	DATE	TITLE		Amphenol®	
X. X.X ±0.30 X.XX ±0.20 X.XXX ±0.10	DRAWN <b>Sondra Sang</b>	08/14/2015	BOARD TO BOARD CONN. 0.80mm PITCH PLUG		Amphenol Corporation Amphenol Taiwan Corporation	
ANGULAR ±1°	CHECKED <b>Chenny Yeh</b>	08/14/2015			PART No.	G832MB 1X XXX XX2X HR
UNLESS OTHERWISE SPECIFIED	APPROVED <b>Hank Hsu</b>	08/14/2015			UNIT	mm
	DWG TYPE CUST DWG	PROJECT CODE TXXX	SCALE	NA	SHEET	1 OF 1
			DWG No.	G832MB1XXXXXX2XHR	REV.	AX5