



Chipsmall Limited consists of a professional team with an average of over 10 year of expertise in the distribution of electronic components. Based in Hongkong, we have already established firm and mutual-benefit business relationships with customers from,Europe,America and south Asia,supplying obsolete and hard-to-find components to meet their specific needs.

With the principle of “Quality Parts,Customers Priority,Honest Operation,and Considerate Service”,our business mainly focus on the distribution of electronic components. Line cards we deal with include Microchip,ALPS,ROHM,Xilinx,Pulse,ON,Everlight and Freescale. Main products comprise IC,Modules,Potentiometer,IC Socket,Relay,Connector.Our parts cover such applications as commercial,industrial, and automotives areas.

We are looking forward to setting up business relationship with you and hope to provide you with the best service and solution. Let us make a better world for our industry!



Contact us

Tel: +86-755-8981 8866 Fax: +86-755-8427 6832

Email & Skype: info@chipsmall.com Web: www.chipsmall.com

Address: A1208, Overseas Decoration Building, #122 Zhenhua RD., Futian, Shenzhen, China



This document is the property of Amphenol Corporation and is delivered on the express condition that it is not to be disclosed, reproduced or used, in whole or in part, for manufacture or sale by anyone other than Amphenol Corporation without its prior consent, and that the right is granted to disclose or to use any information in this document.

The marking on this product doesn't contain environmental hazardous materials per Material Specification SS-00259 for Sony GP compliant or per directive 2011/65/EU for RoHS compliant.



ORIGINAL

REVISIONS				
SYM	ECN No.	DESCRIPTION	DATE	APPROVED
A	NE-14203	RELEASE TO PRODUCTION	11/10/2014	Arron Lin

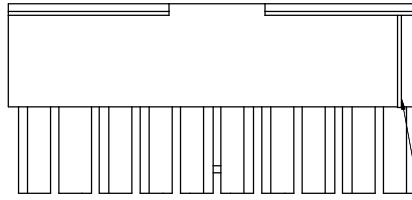
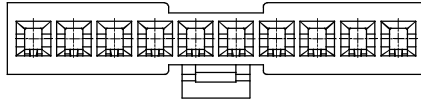

CIRCUIT #1 IDENTIFIER

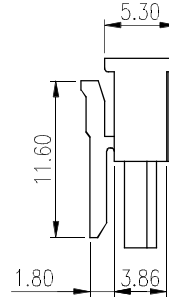
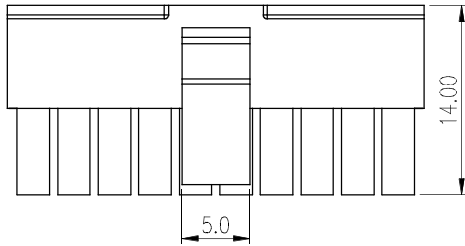

NOTES:

1. MATERIAL:
HOUSING: THERMOPLASTIC, NYLON66, UL94V-0, COLOR: BLACK.
2. PACKING IS PER AMTA PACKING SPECIFICATION PKS-0001.
3. THIS PRODUCT DOESN'T CONTAIN ENVIRONMENTAL HAZARDOUS PER DIRECTIVE 2011/65/EU FOR RoHS COMPLIANT.
4. RECOMMENDED TERMINAL P/N: G881C0232CEU

P/N: G881H XX 21C3HR
POS.

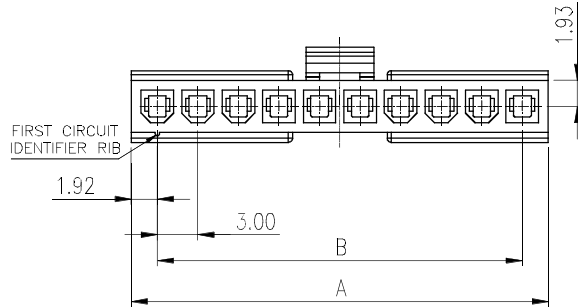

(3-12 CIRCUIT HOUSING)

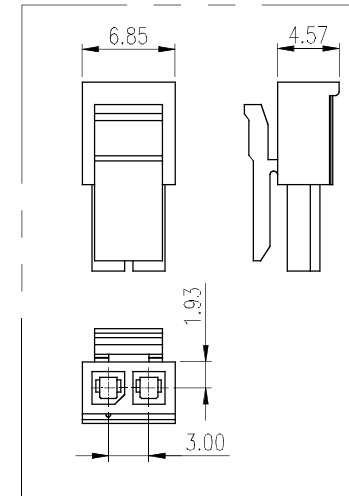

(2 CIRCUIT HOUSING)

POS	A	B
02	6.85	3.00
03	9.85	6.00
04	12.85	9.00
05	15.85	12.00
06	18.85	15.00
07	21.85	18.00
08	24.85	21.00
09	27.85	24.00
10	30.85	27.00
11	33.85	30.00
12	36.85	33.00

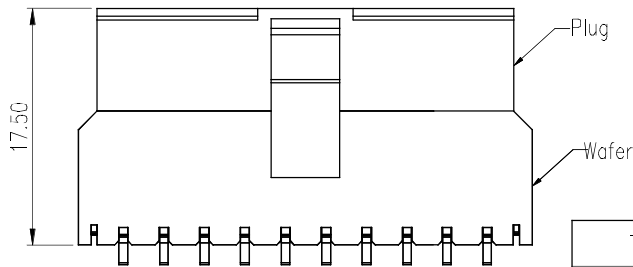
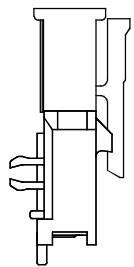

MATED MICRO POWER CONNECTOR

TOLERANCE	APPROVALS	DATE	TITLE			Amphenol®		
X. X.X ±0.30 X.XX ±0.20 X.XXX ±0.10	DRAWN Debby Hung	11/10/2014	MICRO POWER CONNECTOR 3.0MM PITCH, SINGLE ROWS HOUSING ,CRIMPING TYPE			Amphenol Corporation Amphenol Taiwan Corporation		
ANGULAR ±1°	CHECKED Roger Tsai	11/10/2014	UNIT mm	SIZE A3	PART No. G881HXX21C3HR			
UNLESS OTHERWISE SPECIFIED	APPROVED Arron Lin	11/10/2014	SCALE NA	SHEET 1 OF 2	DWG No. G881HXX21C3HR	REV. A		
	DWG TYPE CUST DWG	PROJECT CODE SKT						

This document is the property of Amphenol Corporation and is delivered on the express condition that it is not to be disclosed, reproduced or used, in whole or in part, for manufacture or sale by anyone other than Amphenol Corporation without its prior consent, and that no right is granted to disclose or to use any information in this document.

The marking on this product doesn't contain environmental hazardous materials per Material Specification SS-00259 for Sony GP compliant or per directive 2011/65/EU for RoHS compliant.



ORIGINAL



REVISIONS				
SYM	ECN No.	DESCRIPTION	DATE	APPROVED
A	NE-14203	RELEASE TO PRODUCTION	11/10/2014	Arron Lin

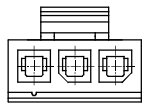

3 POS

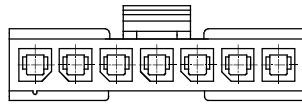

7 POS

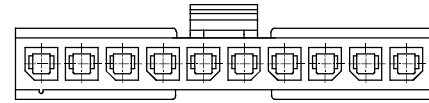

10 POS

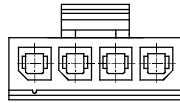

4 POS

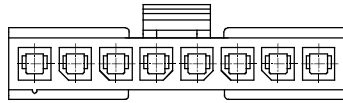

8 POS

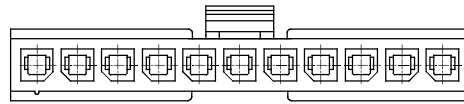

11 POS

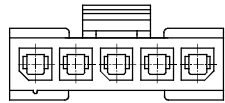

5 POS

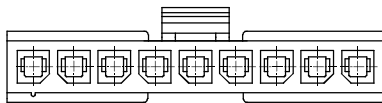

9 POS

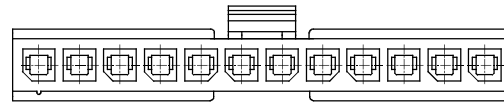

12 POS

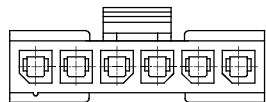

6 POS

TOLERANCE		APPROVALS	DATE	TITLE		Amphenol ® Amphenol Corporation Amphenol Taiwan Corporation				
X.		DRAWN	Debby Hung	11/10/2014	MICRO POWER CONNECTOR		G881HXX21C3HR G881HXX21C3HR A			
X.X	±0.30	CHECKED	Roger Tsai	11/10/2014	3.0MM PITCH, SINGLE ROWS					
X.XX	±0.20	APPROVED	Arron Lin	11/10/2014	HOUSING ,CRIMPING TYPE					
X.XXX	±0.10	DWG TYPE	CUST DWG	PROJECT CODE						
ANGULAR	±1°	UNLESS OTHERWISE SPECIFIED		SKT	UNIT	mm	SIZE	A3	PAPT No.	
					SCALE	NA	SHEET	2 OF 2	REV.	

This document is the property of Amphenol Corporation and is delivered on the express condition that is not to be disclosed, reproduced or used in whole or in part, for manufacture or sale by anyone other than Amphenol Corporation without its prior consent, and that no right is granted to disclose or to use any information in this document.

The marking on this product doesn't contain environmental hazardous materials per Material Specification SS-00259 for Sony GP compliant or per directive 2011/65/EU for RoHS compliant.



ORIGINAL



REVISIONS				
SYM	ECN No.	DESCRIPTION	DATE	APPROVED
A	NE-14203	RELEASE TO PRODUCTION	11/10/2014	Arron Lin

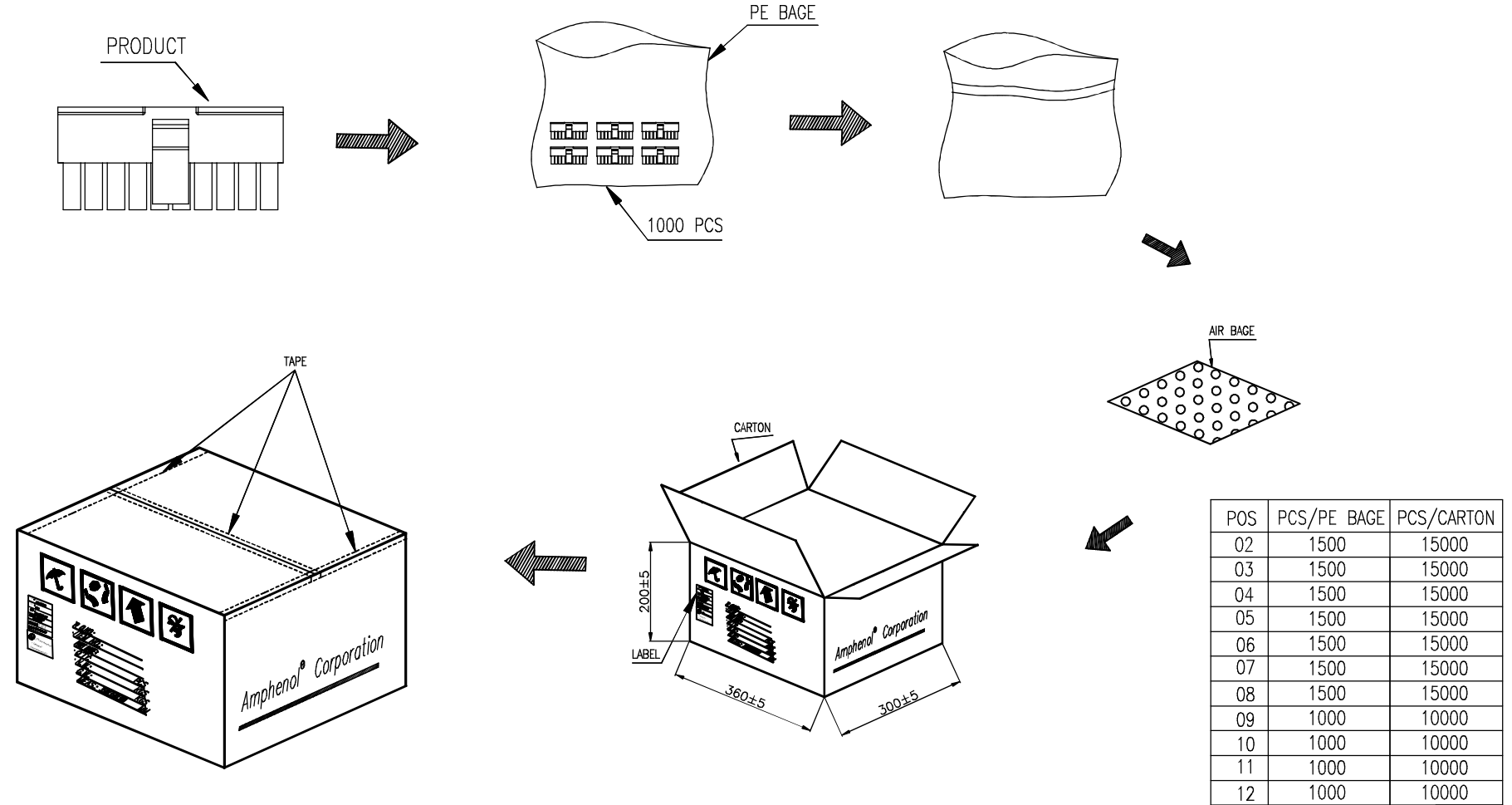

POS	PCS/PE BAG	PCS/CARTON
02	1500	15000
03	1500	15000
04	1500	15000
05	1500	15000
06	1500	15000
07	1500	15000
08	1500	15000
09	1000	10000
10	1000	10000
11	1000	10000
12	1000	10000

TOLERANCE	APPROVALS	DATE	TITLE			Amphenol®		
X. ±0.30	DRAWN Debby Hung	11/10/2014	MICRO POWER CONNECTOR 3.0MM PITCH, SINGLE ROWS HOUSING ,CRIMPING TYPE			Amphenol Corporation Amphenol Taiwan Corporation		
X.X ±0.20								
X.XX ±0.20	CHECKED Roger Tsai	11/10/2014	UNIT mm SIZE A3 PART No. G881HXX21C3HR			DVG No. G881HXX21C3HR REV. A		
X.XXX ±0.10								
ANGULAR ±1°	APPROVED Arron Lin	11/10/2014	SCALE NA SHEET 2 OF 2					
UNLESS OTHERWISE SPECIFIED	DWG TYPE CUST DWG	PROJECT CODE SKT						