



Chipsmall Limited consists of a professional team with an average of over 10 year of expertise in the distribution of electronic components. Based in Hongkong, we have already established firm and mutual-benefit business relationships with customers from,Europe,America and south Asia,supplying obsolete and hard-to-find components to meet their specific needs.

With the principle of “Quality Parts,Customers Priority,Honest Operation,and Considerate Service”,our business mainly focus on the distribution of electronic components. Line cards we deal with include Microchip,ALPS,ROHM,Xilinx,Pulse,ON,Everlight and Freescale. Main products comprise IC,Modules,Potentiometer,IC Socket,Relay,Connector.Our parts cover such applications as commercial,industrial, and automotives areas.

We are looking forward to setting up business relationship with you and hope to provide you with the best service and solution. Let us make a better world for our industry!



Contact us

Tel: +86-755-8981 8866 Fax: +86-755-8427 6832

Email & Skype: info@chipsmall.com Web: www.chipsmall.com

Address: A1208, Overseas Decoration Building, #122 Zhenhua RD., Futian, Shenzhen, China



Hybridization of a Magnetic Relay and an SSR Achieves 10-A Switching for 10 Million Operations.

- UL/CSA certified (-US models).
- Using a triac to open and close the circuit reduces chattering and arcing, thereby increasing the electrical durability to 10 million operations.
- Relays contacts for power ON and 10-A switching with high-capacity are provided in a compact body without the need of radiators. Plus, there is almost no effect on heat generation or ambient temperature.
- Operation indicators to easily check operation.
- Built-in temperature fuse prevents internal burning due to triac or relay malfunctions.
- Socket-type Relays the same size as the 1-pole and 2-pole LY Relays.

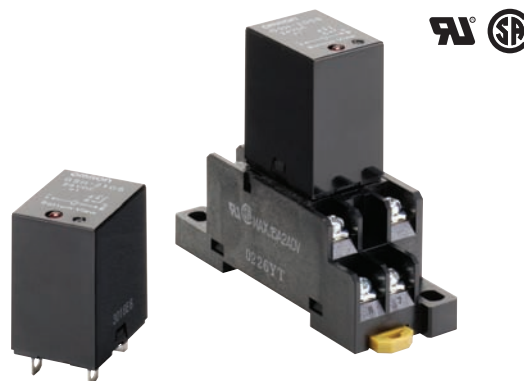

For the most recent information on models that have been certified for safety standards, refer to your OMRON website.



Refer to *Safety Precautions for All Solid State Relays*.

Ordering Information

List of Model

Isolation method	Zero cross function	Operation indicator	Applicable output load (See note.)	Rated input voltage	Model
Relay	No	Yes	5 A 100 to 240 VAC	5 VDC	G9H-205S DC5 G9H-205S-US DC5
				12 VDC	G9H-205S DC12 G9H-205S-US DC12
				24 VDC	G9H-205S DC24 G9H-205S-US DC24
				5 VDC	G9H-210S DC5 G9H-210S-US DC5
				12 VDC	G9H-210S DC12 G9H-210S-US DC12
				24 VDC	G9H-210S DC24 G9H-210S-US DC24

Note: 1. The actual product is labeled "250 VAC."

2. For information on products that are certified for international standards, consult your OMRON sales representatives

Accessories (Order Separately)

Connecting Socket Mounting Plate

Model	Minimum quantity packaged (units)
PYP-1	10
PYP-18	1

Note: Order the models above in increments of the minimum quantity packaged.

Specifications

■ Ratings

Input

Rated voltage	Item	Operating voltage	Coil resistance	Must operate voltage	Must release voltage	Power consumption
DC	5 V	4 to 6 VDC	104 Ω	4 VDC max.	0.5 VDC min.	Approx. 240 mW
	12 V	9.6 to 14.4 VDC	600 Ω	9.6 VDC max.	1.2 VDC min.	
	24 V	19.2 to 28.8 VDC	2,400 Ω	19.2 VDC max.	2.4 VDC min.	

Note: 1. The coil resistance is measured at a coil temperature of 23°C with a tolerance of ±10%.

2. Performance characteristic data are measured at a coil temperature of 23°C.

Output

Model	Item	Applicable load			
		Rated load voltage	Load voltage range	Load current (See note.)	Inrush current resistance
G9H-205S		100 to 240 VAC	75 to 264 VAC	50 mA to 5 A (at 55°C)	80 A (60 Hz, 1 cycle)
G9H-210S				50 mA to 10 A (at 55°C)	170 A (60 Hz, 1 cycle)

Note: The load current depends on the ambient temperature. For details, refer to *Load Current vs. Ambient Temperature* in Engineering Data.

■ Characteristics

Item	Model	G9H-205S	G9H-210S
Operate time		10 ms max.	
Release time		1/2 cycle max. + 10 ms	
Output ON voltage drop		1.6 V max. (RMS) (at 5 A)	1.6 V max. (RMS) (at 10 A)
Leakage current		5 mA max. at 250 VAC	
Inrush current resistance		80 A	170 A
Temperature rise		50°C max. (rated voltage applied using resistance method)	
Insulation resistance		100 MΩ min. (at 500 VDC)	
Dielectric strength		2,000 VAC 50/60 Hz 1 min	
Vibration resistance	Destruction	10 to 55 to 10 Hz, 1-mm single amplitude (2-mm double amplitude)	
	Malfunction	10 to 45 to 10 Hz, 1-mm single amplitude (2-mm double amplitude)	
Shock resistance (See note.)	Destruction	1,000 m/s ²	
	Malfunction	100 m/s ²	
Life expectancy	Mechanical	10 million operations min. (switching frequency: 18,000 operations/hour)	
	Electrical	10 million operations min. (resistive load and switching frequency: 18,000 operations/hour)	
Storage temperature		-25 to 70°C (with no icing or condensation)	
Ambient operating temperature		-25 to 60°C (with no icing or condensation)	
Ambient operating humidity		35% to 85%	
Weight		Approx. 25 g	

Note: Value when excited.

Connection

■ Layout

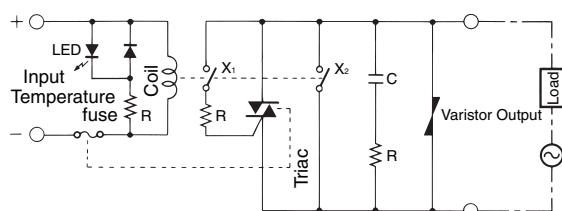

Engineering Data

Load Current vs. Ambient Temperature

Resistive load

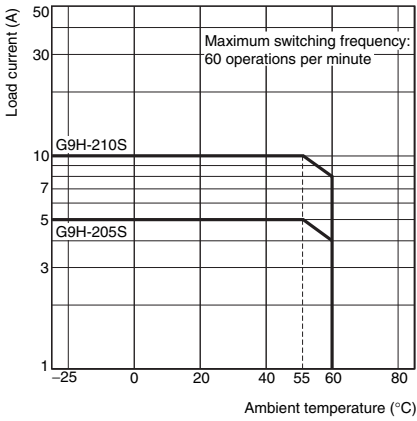

Lamp load (Inrush current: 6 times the rated current, Inrush current time: 2 cycles)

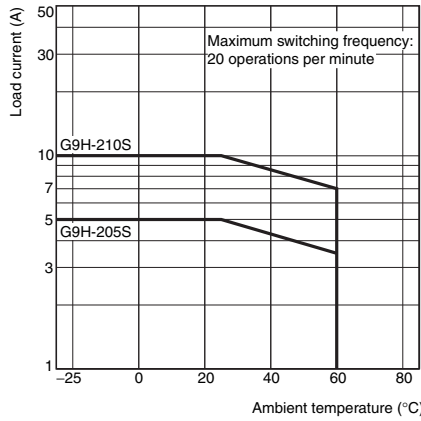

Motor load (Inrush current: 4 times the rated current, Inrush current time: 12 cycles)

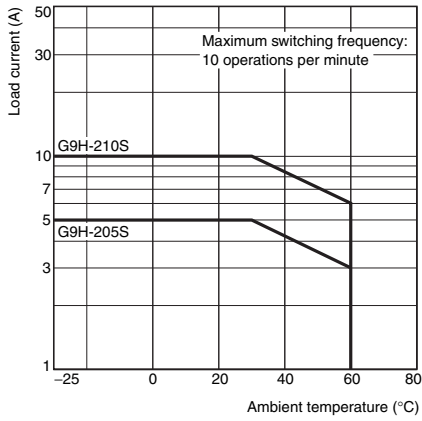

Inrush Current Resistance vs. ON Time

Non-repetitive (Keep the inrush current below the dotted line if it occurs repetitively.)

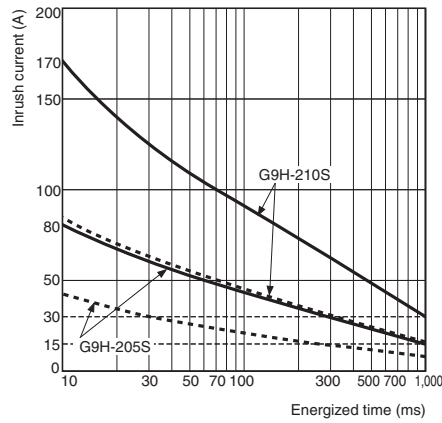

Dimensions

Note: All units are in millimeters unless otherwise indicated.

Hybrid Power Relays

G9H-205S
G9H-210S

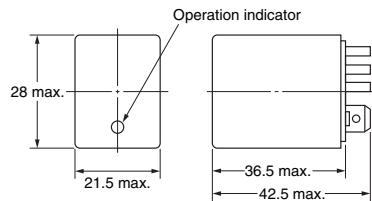

Terminal Arrangement/Internal Connections (Bottom View)

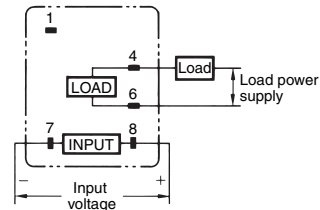

■ Accessories (Order Separately)

Connecting Socket/Hold-Down Clips

	Front-mounting Sockets	Back-mounting Sockets		
Socket	PTF08A(-E)	PT08	PT08-0	PT08QN
Hold-down Clip	PYC-A1	PYC-P PYC-S	PYC-P	PYC-P PYC-S

Connecting Socket Mounting Plate (t = 1.6)

Use a Mounting Plate when two or more Connecting Sockets are mounted side by side.

Types of Mounting Plates are available: the PYP-1 (for mounting one Unit) and the PYP-18 (for mounting up to 18 Units). The Mounting Plate for 18 Units can be cut to the desired length before use.

PYP-1

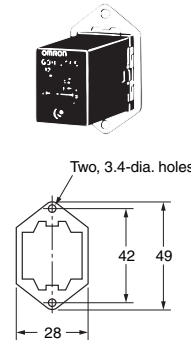

PYP-18

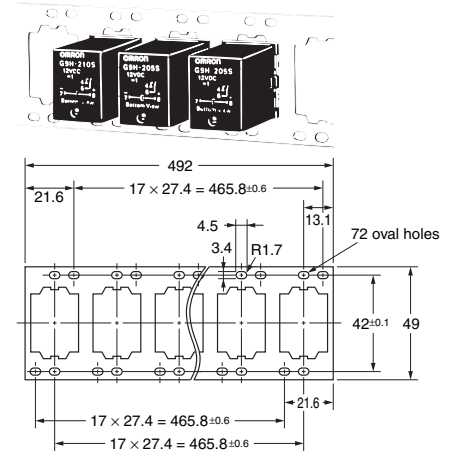

Safety Precautions

Refer to *Safety Precautions for All Solid State Relays*.

ALL DIMENSIONS SHOWN ARE IN MILLIMETERS.

To convert millimeters into inches, multiply by 0.03937. To convert grams into ounces, multiply by 0.03527.

In the interest of product improvement, specifications are subject to change without notice.

Terms and Conditions Agreement

Read and understand this catalog.

Please read and understand this catalog before purchasing the products. Please consult your OMRON representative if you have any questions or comments.

Warranties.

(a) Exclusive Warranty. Omron's exclusive warranty is that the Products will be free from defects in materials and workmanship for a period of twelve months from the date of sale by Omron (or such other period expressed in writing by Omron). Omron disclaims all other warranties, express or implied.

(b) Limitations. OMRON MAKES NO WARRANTY OR REPRESENTATION, EXPRESS OR IMPLIED, ABOUT NON-INFRINGEMENT, MERCHANTABILITY OR FITNESS FOR A PARTICULAR PURPOSE OF THE PRODUCTS. BUYER ACKNOWLEDGES THAT IT ALONE HAS DETERMINED THAT THE PRODUCTS WILL SUITABLY MEET THE REQUIREMENTS OF THEIR INTENDED USE.

Omron further disclaims all warranties and responsibility of any type for claims or expenses based on infringement by the Products or otherwise of any intellectual property right. (c) Buyer Remedy. Omron's sole obligation hereunder shall be, at Omron's election, to (i) replace (in the form originally shipped with Buyer responsible for labor charges for removal or replacement thereof) the non-complying Product, (ii) repair the non-complying Product, or (iii) repay or credit Buyer an amount equal to the purchase price of the non-complying Product; provided that in no event shall Omron be responsible for warranty, repair, indemnity or any other claims or expenses regarding the Products unless Omron's analysis confirms that the Products were properly handled, stored, installed and maintained and not subject to contamination, abuse, misuse or inappropriate modification. Return of any Products by Buyer must be approved in writing by Omron before shipment. Omron Companies shall not be liable for the suitability or unsuitability or the results from the use of Products in combination with any electrical or electronic components, circuits, system assemblies or any other materials or substances or environments. Any advice, recommendations or information given orally or in writing, are not to be construed as an amendment or addition to the above warranty.

See <http://www.omron.com/global/> or contact your Omron representative for published information.

Limitation on Liability; Etc.

OMRON COMPANIES SHALL NOT BE LIABLE FOR SPECIAL, INDIRECT, INCIDENTAL, OR CONSEQUENTIAL DAMAGES, LOSS OF PROFITS OR PRODUCTION OR COMMERCIAL LOSS IN ANY WAY CONNECTED WITH THE PRODUCTS, WHETHER SUCH CLAIM IS BASED IN CONTRACT, WARRANTY, NEGLIGENCE OR STRICT LIABILITY.

Further, in no event shall liability of Omron Companies exceed the individual price of the Product on which liability is asserted.

Suitability of Use.

Omron Companies shall not be responsible for conformity with any standards, codes or regulations which apply to the combination of the Product in the Buyer's application or use of the Product. At Buyer's request, Omron will provide applicable third party certification documents identifying ratings and limitations of use which apply to the Product. This information by itself is not sufficient for a complete determination of the suitability of the Product in combination with the end product, machine, system, or other application or use. Buyer shall be solely responsible for determining appropriateness of the particular Product with respect to Buyer's application, product or system. Buyer shall take application responsibility in all cases.

NEVER USE THE PRODUCT FOR AN APPLICATION INVOLVING SERIOUS RISK TO LIFE OR PROPERTY OR IN LARGE QUANTITIES WITHOUT ENSURING THAT THE SYSTEM AS A WHOLE HAS BEEN DESIGNED TO ADDRESS THE RISKS, AND THAT THE OMRON PRODUCT(S) IS PROPERLY RATED AND INSTALLED FOR THE INTENDED USE WITHIN THE OVERALL EQUIPMENT OR SYSTEM.

Programmable Products.

Omron Companies shall not be responsible for the user's programming of a programmable Product, or any consequence thereof.

Performance Data.

Data presented in Omron Company websites, catalogs and other materials is provided as a guide for the user in determining suitability and does not constitute a warranty. It may represent the result of Omron's test conditions, and the user must correlate it to actual application requirements. Actual performance is subject to the Omron's Warranty and Limitations of Liability.

Change in Specifications.

Product specifications and accessories may be changed at any time based on improvements and other reasons. It is our practice to change part numbers when published ratings or features are changed, or when significant construction changes are made. However, some specifications of the Product may be changed without any notice. When in doubt, special part numbers may be assigned to fix or establish key specifications for your application. Please consult with your Omron's representative at any time to confirm actual specifications of purchased Product.

Errors and Omissions.

Information presented by Omron Companies has been checked and is believed to be accurate; however, no responsibility is assumed for clerical, typographical or proofreading errors or omissions.