



Chipsmall Limited consists of a professional team with an average of over 10 year of expertise in the distribution of electronic components. Based in Hongkong, we have already established firm and mutual-benefit business relationships with customers from,Europe,America and south Asia,supplying obsolete and hard-to-find components to meet their specific needs.

With the principle of "Quality Parts,Customers Priority,Honest Operation,and Considerate Service",our business mainly focus on the distribution of electronic components. Line cards we deal with include Microchip,ALPS,ROHM,Xilinx,Pulse,ON,Everlight and Freescale. Main products comprise IC,Modules,Potentiometer,IC Socket,Relay,Connector.Our parts cover such applications as commercial,industrial, and automotives areas.

We are looking forward to setting up business relationship with you and hope to provide you with the best service and solution. Let us make a better world for our industry!



Contact us

Tel: +86-755-8981 8866 Fax: +86-755-8427 6832

Email & Skype: info@chipsmall.com Web: www.chipsmall.com

Address: A1208, Overseas Decoration Building, #122 Zhenhua RD., Futian, Shenzhen, China



Low-speed Monitoring Unit G9SX-LM

Low-speed Monitoring Function Ensures Safety for Maintenance Work



- Motor rotation speed detected by Proximity Sensor.
- Monitors and confirms that speed does not exceed the preset level.
- Includes an Enabling Switch input for maintenance work.
- Detailed LED indications enable easy fault diagnosis.
- PLd/Safety Category 3 (ISO 13849-1), SIL 3 (IEC/EN 62061) certified.



Be sure to read the "Precautions" on page 22

For the most recent information on models that have been certified for safety standards, refer to your OMRON website.

Model Number Structure

Model Number Legend

G9SX-□□□□-□□□□-□□
 1 2 3 4 5 6

1. Functions

LM: Low Speed Monitoring Unit
 EX: Expansion Unit

2. Output Configuration (Safety instantaneous output)

2: 2 outputs
 4: 4 outputs

3. Output Configuration (Safety Speed detection output)

2: 2 outputs

4. Output Configuration (Auxiliary output)

1: 1 output
 4: 4 outputs

5. Maximum preset value

Low-Speed Monitoring Unit
 F10: 10Hz
Expansion Unit
 No indicator: No OFF delay

6. Terminal block type

RT: Screw terminals
 RC: Spring-cage terminals

List of Models

Low-speed Monitoring Unit

Safety instantaneous output	Safety slow-speed/stopping detection output	Auxiliary output	Maximum set threshold	Rated voltage	Terminal block type	Model
2 (Semiconductor)	2 (Semiconductor)	4 (Semiconductor)	10 Hz	24 VDC	Screw terminals	G9SX-LM224-F10-RT
					Spring-cage terminals	G9SX-LM224-F10-RC

Expansion Unit

Safety outputs		Auxiliary outputs	OFF-delay time	Rated voltage	Terminal block type	Model
Instantaneous	OFF-delayed					
4a (contact)	0	1 (Semiconductor)	--	24 VDC	Screw terminals	G9SX-EX401-RT
					Spring-cage terminals	G9SX-EX401-RC

G9SX-LM

Specifications

Ratings

Power input

Item	Model	G9SX-LM224-□	G9SX-EX401-□
Rated supply voltage		24 VDC	
Operating voltage range		-15% to +10% of rated supply voltage	
Power consumption *		5 W max.	2 W max.

* Power consumption of loads not included.

Inputs

Item	Model	G9SX-LM224-□
Safety input Enabling input Feedback/reset input Mode selector input		Operating voltage: 20.4 VDC to 26.4 VDC Internal impedance: Approx. 2.8 kΩ *
Rotation detection input		Operating voltage: 20.4 VDC to 26.4 VDC Internal impedance: Approx. 2.8 kΩ * Frequency input range: 1 kHz max.

* Provide a current equal to or higher than that of the minimum applicable load of the connected input control device.

Outputs

Item	Model	G9SX-LM224-□
Safety instantaneous output *1		Source output (PNP compatible) Load current: 0.8 A DC max. *2
Safety speed detection output *1		Source output (PNP compatible) Load current: 0.3 A DC max.
Auxiliary output		Source output (PNP compatible) Load current: 100 mA DC max.

*1. While safety instantaneous outputs and safety speed detection outputs are in the ON state, the following pulse signal is output continuously for output circuit diagnosis.

When using these safety outputs as input signals to control devices (i.e. Programmable Controllers), consider the pulse signal shown below.

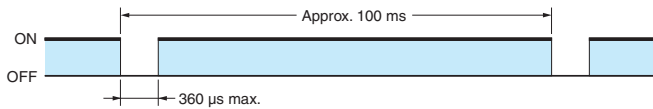

*2. The following derating is required when Units are mounted side-by-side.
G9SX-LM□: 0.4 A DC max. load current

Expansion Unit

Item	Model	G9SX-EX-□
Rated load		250 VAC, 3A /30 VDC, 3A (resistive load)
Rated carry current		3A
Maximum switching voltage		250 VAC, 125 VDC

Characteristics

Item	Model	G9SX-LM224	G9SX-EX401
Over-voltage category (IEC/EN60664-1)		II	II (Safety relay outputs 13 to 43 and 14 to 44: III)
Operating time (OFF to ON state) *1 *2 *5		50 ms max. (Safety input: ON, Enabling input: ON) 100 ms max. (Logical AND connection input: ON)	30 ms max. *6
Response time (ON to OFF state) *1 *5		15 ms max.	10 ms max. *6
Allowable time for switching Mode selector inputs *3		450 ms max.	--
Mode selector input response time *4		50 ms max.	--
ON-state residual voltage		3.0 V max. (safety instantaneous outputs, safety speed detection outputs, and auxiliary outputs)	
OFF-state leakage current		0.1 mA max. (safety instantaneous outputs, safety speed detection outputs, and auxiliary outputs)	
Maximum cable length for logical connection inputs and Safety inputs		100 m max. (External connection impedance: 100 Ω max. and 10 nF max.)	
Reset input time		100 ms min.	
Accuracy tolerance of low speed detection frequency		Within minus 10% of the set value	--
Insulation resistance	Between logical AND connection terminals, and power supply input terminals and other input and output terminals connected together	20 MΩ min., 250 VDC megger	--
	Between all terminals connected together and DIN rail		100 MΩ min., 500 VDC megger
Dielectric strength	Between logical AND connection terminals, and power supply input terminals and other input and output terminals connected together	500 VAC for 1 min	--
	Between all terminals connected together and DIN rail		1,200 VAC for 1 min
	Between different poles of outputs	--	1,200 VAC for 1 min
	Between safety relay outputs connected together and other terminals connected together	--	2,200 VAC for 1 min
Vibration resistance		Frequency: 10 to 55 to 10 Hz, 0.375-mm single amplitude (0.75-mm double amplitude)	
Mechanical shock resistance	Destruction	300 m/s ²	
	Malfunction	100 m/s ²	
Durability	Electrical	--	100,000 cycles min. (rated load, switching frequency: 1,800 cycles/hour)
	Mechanical	--	5,000,000 cycles min. (switching frequency: 7,200 cycles/hour)
Ambient temperature		-10 to 55°C (no icing or condensation)	
Ambient humidity		25% to 85%	
Terminal tightening torque *7		0.6 N·m	
Weight		Approx. 240 g	Approx. 165 g

*1. When two or more Units are connected by logical AND, the operating time and response time are the sum total of the operating times and response times, respectively, of all the Units connected by logical AND.

*2. Represents the time required to turn ON safety instantaneous outputs when required conditions are met.

*3. Represents the time allowed for switching mode selector inputs. If it exceeds 450 ms, G9SX-LM□ will detect it as a failure.

*4. Represents the time required for safety inputs/enabling inputs to be switched following a switch of mode selector inputs.

*5. Operating time and response time do not include the frequency detection time and the time affected by the characteristics of proximity sensors. For response performance of the entire system, see "(5) Response performance regarding speed detection".

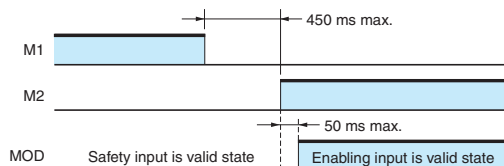

*6. The value of the operating time and response time of the connected Low-speed Monitoring Unit is not included.

*7. For the G9SX-□-RT (with screw terminals)

Logical AND Connection

Item	Model	G9SX-LM224	G9SX-EX401-□
Number of Units connected per logical AND output		4 units max.	--
Total number of Units connected by logical AND *		20 units max.	--
Number of Units connected in series by logical AND		5 units max.	--
Max. number of Expansion Units connected		--	5 units max.
Maximum cable length for logical AND input		100 m max.	--

* The number of G9SX-EX401-□ Expansion Units not included.

G9SX-LM

Connections

Internal Connection

G9SX-LM224-□ (Low-speed Monitoring Unit)

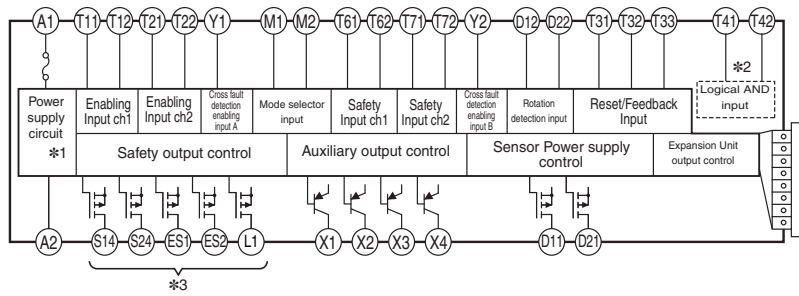

- *1. Internal power supply circuit is not isolated.
- *2. Logical AND input is isolated.
- *3. Outputs S14 , S24, ES1, ES2, and L1 are internally redundant.

G9SX-EX401-□ (Expansion Unit)

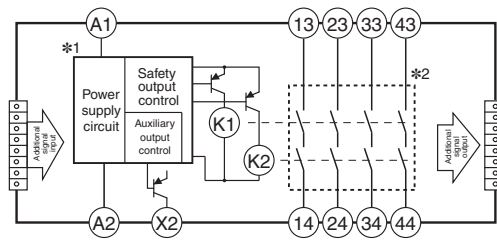

- *1. Internal power supply circuit is not isolated.
- *2. Relay outputs are isolated.

Wiring of Inputs and Outputs

Signal Name	Terminal Name	Description of operation	Wiring
Power supply input	A1, A2	The input terminals for power supply. Connect the power source to the A1 and A2 terminals.	Connect the power supply plus (24 VDC) to the A1 terminal. Connect the power supply minus (GND) to the A2 terminal.
Enabling input ch1	T11, T12	To set Safety instantaneous outputs in the ON state in the Maintenance mode, HIGH state signals must be input to both of enabling input CH1 and enabling input CH2. Otherwise Safety instantaneous outputs cannot be in the ON state.	Using 1 safety input channel
			Using 2 safety input channels (cross fault detection OFF)
Enabling input ch2	T21, T22	To set Safety instantaneous outputs in the ON state in the Normal operating mode, HIGH state signals must be input to both of Safety input CH1 and Safety input CH2. Otherwise Safety instantaneous outputs cannot be in ON state.	Using 2 safety input channels (cross fault detection ON)
			Using 2 safety input channels (cross fault detection OFF)
Safety input ch1	T61, T62		Using 1 safety input channel
Safety input ch2	T71, T72	To set Safety instantaneous outputs in ON state in the Normal operating mode, HIGH state signals must be input to both of Safety input CH1 and Safety input CH2. Otherwise Safety instantaneous outputs cannot be in ON state.	Using 2 safety input channels (cross fault detection OFF)
			Using 2 safety input channels (cross fault detection ON)
Reset/Feedback Input	T31, T32, T33	To set Safety instantaneous outputs in the ON state, the ON state signal must be input to T33. Otherwise Safety instantaneous outputs cannot be in the ON state. To set Safety instantaneous outputs in the ON state, the signal input to T32 must change from the OFF state to the ON state, and then to the OFF state. Otherwise Safety instantaneous outputs cannot be in the ON state.	Auto reset
			Manual reset
Logical AND connection input	T41, T42	The logical AND connection means that lower unit (Unit B) calculates the logical multiplication (AND) of the safety output information from upper unit (Unit A) and safety input signal "b", which is input to lower unit. In the example of a right picture, the safety output of Unit C is "a" AND "b". Connect L1 or L2 of upper unit to T41 of lower unit, and connect GND of upper unit to T42 of lower unit. To set Safety instantaneous outputs of the subsequent Unit in ON state, its Logical AND Connection Preset Switch must be set to AND (enabled) and High state signal must be input to T41 of the subsequent unit.	

Signal Name	Terminal Name	Description of operation	Wiring
Mode selector input	M1, M2	Either Safety input or Enabling input is effectively done by 1NC and 1NO inputs. The relationship between Safety/Enabling input and Mode selector inputs is as follows: M1 = ON, M2 = OFF → Safety input is enabled (Normal operating mode) M1 = OFF, M2 = ON → Enabling input is enabled (Maintenance mode)	
Rotation detection input	D11, D12, D21, D22	Normal operating mode: To turn on Safety speed detection outputs, pulse signals from the two proximity sensors detection should be 2.0 Hz max. Maintenance mode: To turn on Safety speed detection outputs, the signal frequency from the two proximity sensors should be lower than the low speed detection settings value.	<p>Use the following DC three-wire types, OMRON E2E series (PNP). E2E-X1R5F1□ E2E-X2F1□ E2E-X5F1□ E2E-X2MF1□ E2E-X5MF1□ E2E-X10MF1□</p>
Cross fault detection input	Y1, Y2	Selects a mode of failure detecting (Cross fault detecting) function for safety inputs and enabling inputs of G9SX-LM□ corresponding to the connection of Cross fault detection input.	<p>Keep Y1 open when using T11, T21. (cross fault detection wiring) Keep Y2 open when using T61, T71. (cross fault detection wiring) Connect Y1 to 24 VDC when not using T11, T21. (cross fault detection wiring, or when connecting safety sensors) Connect Y2 to 24 VDC when not using T61, T71. (cross fault detection wiring, or when connecting safety sensors)</p>
Safety instantaneous output	S14, S24	Normal operating mode: Turns ON/OFF according to the state of safety inputs, Feedback/Reset inputs, and Logical AND connection inputs. Maintenance mode: Turns ON/OFF according to the state of enabling inputs, Feedback/Reset inputs, Logical AND connection inputs, and rotation detection inputs.	Keep these outputs open when not used.
Safety speed detection output	ES1, ES2	Turns ON/OFF according to the state of Rotation detection inputs. The safety speed detection outputs are turned ON when the frequency input of Rotation detection input at normal operating mode is 2 Hz or less, or when the input is equal to or less than the low speed detection settings value at the maintenance mode.	Keep these outputs open when not used.
Safety speed detection output	L1	Outputs a signal of the same logic level as the Safety instantaneous outputs.	Keep these outputs open when not used.
Auxiliary monitor output	X1	Outputs a signal of the same logic level as the Safety instantaneous outputs.	Keep these outputs open when not used.
Auxiliary error output	X2	Outputs a signal while the error indicator is lit or blinking.	Keep these outputs open when not used.
Auxiliary monitor output	X3	Outputs a signal of the same logic level as Safety speed detection outputs.	Keep these outputs open when not used.
Auxiliary monitor output	X4	Outputs the operating mode status. Normal operating mode: OFF Maintenance mode: ON	Keep these outputs open when not used.

Connecting Safety Sensors and the G9SX-LM

- When connecting safety sensors to the G9SX-LM□, the Y1 terminal must be connected to 24VDC for enabling input channel. Or for Safety input channel, the Y2 terminal must be connected to 24 VDC.
The G9SX-LM□ will detect a connection error, if the Y1 or Y2 terminal is open.
- In many cases, safety sensor outputs include an OFF-shot pulse for self diagnosis.
The following condition of test pulse is applicable as safety inputs for the G9SX.
 - OFF-shot pulse width of the sensor, during the ON-state: 500 μs max..

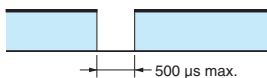

Operation

Functions

Operation Mode

Relationship between G9SX-LM outputs (safety instantaneous outputs and safety speed detection outputs) and inputs (safety input, enabling input, rotation detection input) differs depends on mode selector input status.

Normal operation mode (Mode selector input M1=ON, M2=OFF)

Safety instantaneous outputs and safety speed detection outputs condition turn on depending on rotation detection input condition.

Safety input	ON		OFF	
Enabling input	-	-	-	-
Rotation detection input (low speed detection frequency)	Over 2Hz	Equal to or less than 2Hz	Over 2Hz	Equal to or less than 2Hz
Safety instantaneous output	ON		OFF	
Safety speed detection output	OFF	ON	OFF	ON

Maintenance mode (Mode selector input M1=OFF, M2=ON)

Safety instantaneous outputs changes depending on enabling input and rotation detection input condition. Safety speed detection outputs turn on depending on rotation detection input condition.

Safety input	-	-	-	-
Enabling input	ON		OFF	
Rotation detection input (low speed detection frequency)	Equal to or less than the preset value	Over the preset value	Equal to or less than the preset value	Over the preset value
Safety instantaneous output	ON	OFF	OFF	
Safety speed detection output	ON	OFF	ON	OFF

- Note:** 1. When the logical AND preset switch is set to AND (enabled), the logical AND connection input must be ON for the safety instantaneous output to be turned ON.
 2. Safety instantaneous outputs turn on when the feedback reset inputs condition satisfies its condition and above stated one. Reset mode (auto reset or manual reset) shall be selected depending on the application.

Logical AND Connection

The logical AND connection means that the Basic Unit (or Advanced Unit) outputs a safety signal "a" to an Advanced Unit, and the Advanced Unit calculates the logical multiplication (AND) of the safety signal "a" and safety signal "b." The safety output of an Advanced Unit with the logical AND connection shown in the following diagram is "a AND "b".

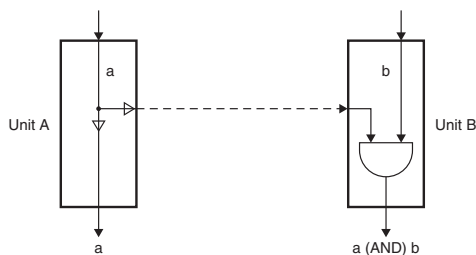

Note: For details on Logical AND Connection, see "G9SX/G9SX-GS Datasheet".

Low-speed Detection Function

Converts the pulse signals from two proximity sensors that monitor the rotation status of hazards to frequency to control the safety speed detection outputs.

- The diagram below shows the relationship between the Low-speed detection frequency and Safety speed detection outputs. The frequency (F) has a tolerance of - 10%.
- This accuracy tolerance does not include any characteristics of proximity sensors.

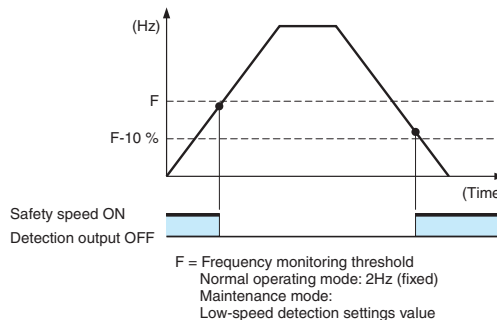

Use the following OMRON E2E series three-wire DC sensors (PNP).

- E2E-X1R5F1
- E2E-X2F1
- E2E-X5F1
- E2E-X2MF1
- E2E-X5MF1
- E2E-X10MF1

Note: 1. To monitor the rotation status of hazards, install a cogwheel for proximity sensors linked to hazards as follows. For design of cogwheel and installation of proximity sensors, see page 13 "Shape of Cogwheel and Setting of Proximity Sensors".

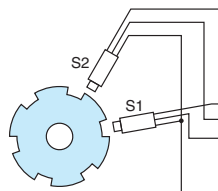

- If G9SX-LM□ is operated without proximity sensors being connected, G9SX-LM□ will detect it as an error.
- If both sensors do not detect the cogwheel, G9SX-LM□ will detect it as an error.

Auxiliary outputs

Auxiliary outputs X1 to X4 can be used to notify outputs, error status, and operation mode.

Terminal name	Signal name	Output ON requirement
X1	Safety instantaneous outputs monitor	X1 is turned ON when Safety instantaneous output is ON.
X2	Error monitor	X2 is turned ON when an error LED indicator is lit or blinking.
X3	Safety speed detection outputs monitor	X3 is turned ON when Safety speed detection output is ON.
X4	Operation mode monitor	X4 is turned ON when in the Maintenance mode.

Connecting Expansion Units

- The G9SX-EX and G9SX-EX-T Expansion Units can be connected to the G9SX-LM□ to increase the number of safety instantaneous outputs.
- When the G9SX-EX-T is connected, it will operate in the same way as G9SX-EX.
- A maximum of five Expansion Units can be connected to one G9SX-LM□. This may be a combination of G9SX-EX Instantaneous types and G9SX-EX-T OFF-delayed types.
- Remove the terminating connector from the receptacle on the G9SX-LM□ and insert the Expansion Unit cable connector into the receptacle. Insert the terminating connector into the receptacle on the Expansion Unit at the very end (rightmost).
- When Expansion Units are connected to an Advanced Unit, make sure that power is supplied to every Expansion Unit. (Refer to the following diagram for actual Expansion Unit connection.)

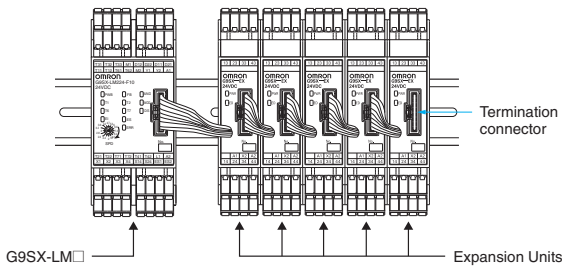

Setting Procedure

(1) Reset Mode

Set the reset mode using feedback/reset input terminals T31, T32, and T33.

Auto reset mode is selected when terminal T32 is shorted to 24 V and manual reset mode is selected when terminal T33 is shorted to 24 V.

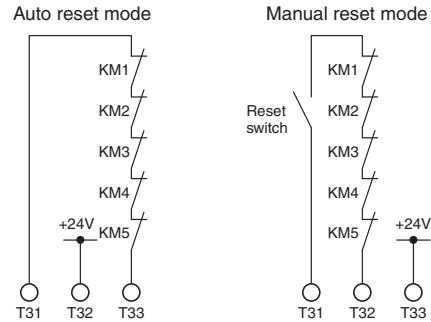

(2) Cross Fault Detection

When connecting safety door switches to safety input and enabling input, cross fault detection can be switched through the Y1 and Y2 terminals.

When the Y1 terminal is open, a cross fault of enabling inputs between T11 and T12, and T21 and T22 is detected. When the Y2 terminal is open, a cross fault of safety inputs between T61 and T62, and T71 and T72 is detected. When a cross fault is detected, the following conditions occur:

- The safety instantaneous outputs, safety speed detection outputs, and logical AND connection outputs lock out.
- The LED error indicator is lit.
- An error output (auxiliary output) is turned ON.

When connecting safety sensors such as safety light curtains to enabling input, be sure to connect the Y1 terminal to +24 V. When connecting safety sensors to safety input, be sure to connect the Y2 terminal to +24 V. If not connected, G9SX-LM□ will detect it as an error.

Cross fault detection	Wiring of enabling inputs and safety inputs	Enabling input	Safety input
OFF	Using 1 safety input channel		
	Using 2 safety input channels		
ON	Using 2 safety input channels		

Note: When using Type 4 safety sensor as a safety input, turn OFF the cross fault detecting function and connect dual-channel output from the sensor to safety inputs terminal.

(3) Setting Logical AND Connection

When connecting two or more Units by logical AND connection, set the logical AND connection preset switch on the Unit that is on the input side to AND.

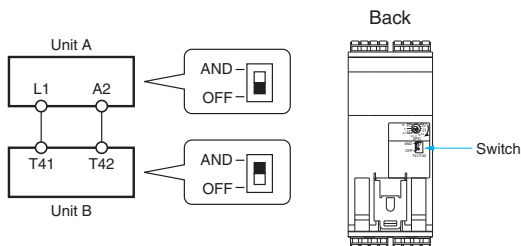

- Note:** 1. A setting error will occur and Unit B will lock out if the logical AND setting switch on the Unit is set to OFF.
 2. Set the logical AND setting switch on Unit A to OFF or the output of Unit A will not turn ON.

(4) Low-speed detection settings

To set a threshold value of low-speed detection frequency, use low-speed detection settings switches (one each on the front and back of the Unit). The Unit operates normally only when the preset values on both switches agree. When the preset values of both switches do not agree, an error occurs.

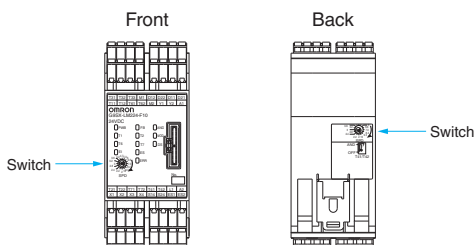

For setting position of preset switches, see the following description:

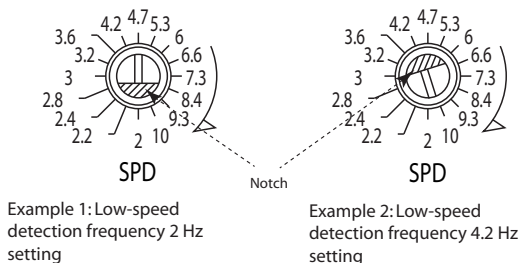

(5) Response performance regarding speed detection

The response time of the entire system regarding speed detection can be calculated by the following formula:

$$T_s = T_p + T_f + T_r + T_m$$

T_s : Response time of the entire system
 T_p : Response time of the proximity sensor
 T_f : Frequency detection time of G9SX-LM
 T_r : Response time of G9SX-LM
 T_m : Response time of the machine

- Frequency detection time of G9SX-LM (T_f)
 The time taken to detect frequency at the rotation detection input section of G9SX-LM. Detection time differs depending on the input frequency. For details, see the diagram below for the characteristics data.

- Response time of proximity sensor (T_p)
 Calculation formula is as follows:
 $T_p = 1 / F$ (s)
 F : Response frequency of the proximity sensor connected to G9SX-LM

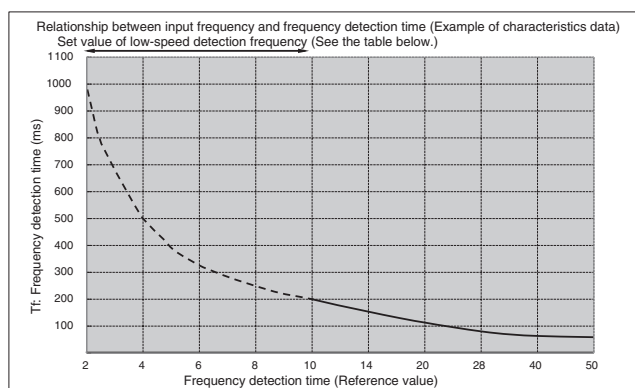

Set value of low-speed detection frequency	Frequency detection time (Reference value)
2 Hz	1000 ms max.
2.2 Hz	910 ms max.
2.4 Hz	835 ms max.
2.8 Hz	715 ms max.
3 Hz	670 ms max.
3.2 Hz	625 ms max.
3.6 Hz	560 ms max.
4.2 Hz	480 ms max.
4.7 Hz	430 ms max.
5.3 Hz	380 ms max.
6 Hz	350 ms max.
6.6 Hz	305 ms max.
7.3 Hz	275 ms max.
8.4 Hz	240 ms max.
9.3 Hz	220 ms max.
10 Hz	200 ms max.

- Response time of G9SX-LM (T_r)
 $T_r = 15\text{ms max.}$
- Response time of the machine (T_m)
 The time from when the machine receives a stop signal to the time when the machine's hazardous part stops.

LED Indicators

Marking	Color	Name	Function
PWR	Green	Power supply indicator	Lights up while power is supplied.
ERR	Red	Error indicator	Lights up or blinks corresponding to the occurring an error. *
T1	Orange	Enabling input ch1 indicator	Lights up while a HIGH state signal is input to T12. Blinks when an error relating to enabling input ch1 occurs. *
T2	Orange	Enabling input ch2 indicator	Lights up while high signal is input to T22. Blinks when an error relating to enabling input ch2 occurs. *
T6	Orange	Safety input ch1 indicator	Lights up while a HIGH state signal is input to T62. Blinks when an error relating to safety input ch1 occurs. *
T7	Orange	Safety input ch2 indicator	Lights up while a HIGH state signal is input to T72. Blinks when an error relating to safety input ch2 occurs. *
AND	Orange	Logical AND input indicator	Lights up while a HIGH state signal is input to T41. Blinks when an error relating to logical AND connection input occurs. *
FB	Orange	Feedback/reset input indicator	<ul style="list-style-type: none"> Automatic reset: Lights up while a HIGH state signal is input to T33. Manual reset: Blinks when an error relating to feedback/reset input occurs.
EI	Orange	Safety instantaneous output indicator	Lights up while the Safety instantaneous outputs (S14, S24) are in the ON-state. Blinks when an error relating to Safety instantaneous output occurs. *
ES	Orange	Safety speed detection output indicator	Lights up while the Safety speed detection outputs (ES1, ES2) are in the ON-state. Blinks when an error relating to the Rotation detection input and Safety speed detection output occurs. *
MOD	Orange	Operation mode indicator	Lights up while the Maintenance mode is in the ON-state. Blinks when an error relating to mode selector input occurs. *
DS	Orange	Rotation detection input indicator	<p>Blinks when Rotation detection input signals (D12 and D22) indicate a low-speed condition (less than the Low-speed detection frequency).</p> <p>Lights up when Rotation detection input signals (D12 and D22) indicate a stopping condition (2Hz or less).</p> <p>Blinks when an error related to Rotation detection input occurs. *</p>

* Refer to Fault Detection on the next page for details.

Settings indication (at power ON)









Settings for G9SX-LM□ can be checked by indicators for approx. 3 seconds after power ON.





During the settings indication term, ERR indicator will light up, however the auxiliary error output will remain OFF.

Indicator	Items	Setting position	Indicator status	Setting mode	Setting status
T1	Cross fault detection (Enabling input)	Y1 terminal	Lit	Detection mode	Y1 = open
			Not lit	Non-detection mode	Y1 = 24 VDC
T6	Cross fault detection (Safety input)	Y2 terminal	Lit	Detection mode	Y2 = open
			Not lit	Non-detection mode	Y2 = 24 VDC
FB	Reset	T33 terminal T32 terminal	Lit	Manual reset mode	Y33 = 24 VDC
			Not lit	Auto reset mode	Y32 = 24 VDC
AND	Logical AND connection	Logical AND connection preset switch	Lit	Enable logical AND input	“AND”
			Not lit	Disable logical AND input	“OFF”

Fault Detection

When the G9SX-LM□ detects a fault, the ERR indicator and/or other indicators light up or blink to inform the user about the fault. Check and take necessary measures referring to the following table, and then re-supply power to the G9SX-LM□.

ERR indicator	Other indicator	Fault	Expected causes of the fault	Check points and measures to take
 Blink	--	Fault due to electromagnetic disturbance or of internal circuits.	1) Excessive electro-magnetic disturbance 2) Failure of the internal circuit	1) Check the disturbance level around the G9SX-LM□ and the related system. 2) Replace with a new product.
 Light up	 T1 blinks	Fault involved with enabling input ch1.	1) Failure involving the wiring of enabling input ch1 2) Incorrect setting of cross fault detection mode 3) Failure of the parts of the circuits of enabling input ch1	1) Check the wiring to T21 and T22. 2) Check the wiring to Y1. 3) Replace with a new product.
	 T2 blinks	Fault involved with enabling input ch2.	1) Failure involving the wiring of enabling input ch2 2) Incorrect setting of cross fault detection mode 3) Failure of the parts of the circuits of enabling input ch2	1) Check the wiring to T21 and T22. 2) Check the wiring to Y1. 3) Replace with a new product.
	 T6 blinks	Fault involved with safety input ch1.	1) Failure involving the wiring of safety input ch1 2) Incorrect setting of cross fault detection mode 3) Failure of the parts of the circuits of safety input ch1	1) Check the wiring to T61 and T62. 2) Check the wiring to Y2. 3) Replace with a new product.
	 T7 blinks	Fault involved with safety input ch2.	1) Failure involving the wiring of safety input ch2 2) Incorrect setting of cross fault detection mode 3) Failure of the parts of the circuits of safety input ch2	1) Check the wiring to T71 and T72. 2) Check the wiring to Y2. 3) Replace with a new product.
	 FB blinks	Fault involved with feedback/reset input.	1) Failure involving the wiring of feedback/reset input. 2) Failure of the parts of the circuits of feedback/reset input	1) Check the wiring to T31, T32, and T33. 2) Replace with a new product.
			Fault of Expansion Units.	1) Improper feedback signals from Expansion Unit 2) Abnormal supply voltage to Expansion Unit 3) Failure of the parts of the circuits of Safety relay contact outputs
 EI blinks	Fault involved with Safety instantaneous outputs or logical AND connection outputs.	1) Failure involving the wiring of Safety instantaneous outputs 2) Failure of the circuit of Safety instantaneous outputs 3) Failure involving the wiring of the logical connection output 4) Failure of the circuit of the logical connection output 5) Impermissible high ambient temperature	1) Check the wiring to S14 and S24. 2) Replace with a new product. 3) Check the wiring to L1 and L2. 4) Replace with a new product. 5) Check the ambient temperature and spacing around G9SX.	

ERR indicator	Other indicator	Fault	Expected causes of the fault	Check points and measures to take
● Light up	 ES blinks	Fault involved with safety speed detection outputs.	<ol style="list-style-type: none"> 1) Failure involving the wiring of safety speed detection outputs 2) Incorrect low speed detection settings 3) Failure of the circuit of safety speed detection outputs 4) Impermissible high ambient temperature 	<ol style="list-style-type: none"> 1) Check the wiring to ES1 and ES2. 2) Check the two of low speed detection settings switches on the front and the back. 3) Replace with a new product. 4) Check the ambient temperature and spacing around G9SX.
	 DS blinks twice for 2s	Fault involved with rotation detection inputs.	<ol style="list-style-type: none"> 1) Failure involving the wiring of rotation detection inputs 2) Failure involving the setting of Proximity sensor 3) Failure of the parts of Proximity sensor 4) Failure of the parts of circuits of rotation detection inputs 	<ol style="list-style-type: none"> 1) Check the wiring to D11, D12, D21, D22, ES1 and Proximity sensor. 2) Refer to "Shape of Cogwheel and Setting for Proximity Sensors" (page 13). 3) Replace with a new E2E. 4) Replace with a new product.
	 DS blinks twice for 2s	Fault involved with rotation detection inputs.	<ol style="list-style-type: none"> 1) Failure involving the upper limit of the rotation detection input frequency 2) Different input frequencies between the Proximity sensors 3) Failure of the parts of circuits of rotation detection inputs 	<ol style="list-style-type: none"> 1) Check the motor. 2) Refer to "Shape of Cogwheel and Setting for Proximity Sensors" (page 13). 3) Replace with a new product.
	 AND blinks	Fault involved with logical AND connection input	<ol style="list-style-type: none"> 1) Failure involving the wiring of the logical AND connection input 2) Incorrect setting for the logical AND connection input 3) Failure of the circuit of the logical AND connection input 	<ol style="list-style-type: none"> 1) Check the wiring to T41 and T42. <ul style="list-style-type: none"> * Make sure that the wiring length for T41 and T42 terminals is less than 100 meters, respectively. * Make sure that the logical AND connection signal is branched for less than 4 units. * Use VCTF cable or shielded cable for Logical AND connection between units. 2) Check the set value of the logical AND connection preset switch. 3) Replace with a new product.
	 MOD blinks	Fault involved with selector switch input.	<ol style="list-style-type: none"> 1) Failure involving the wiring of mode select input 2) Failure of the parts of the circuits of mode select input 3) Failure involving the mode selector switching time 	<ol style="list-style-type: none"> 1) Check the wiring to M1 and M2. 2) Replace with a new product. 3) Check the time set for switching the mode selector switch
	All (without PWR) indicators blink	Supply voltage outside the rated value	1) Supply voltage outside the rated value	1) Check the supply voltage to Expansion Units.

When some indicators blink except ERR indicator, check and take needed actions referring to the following table.

ERR indicator	Other indicator	Fault	Expected causes of the fault	Check points and measures to take
○ Light off	T1	Mismatch between Enabling input ch1 and Enabling input ch2.	Safety input status between enabling input ch1 and enabling input ch2 is different, due to contact failure or short circuit of safety input device(s) or any wiring fault.	Check the wiring from safety input devices to G9SX-LM. Or check the inputs sequence of enabling input devices. After removing the fault, turn both enabling inputs to the OFF state.
	T2			
	T6	Mismatch between Safety input ch1 and Safety input ch2.	Safety input status between safety input ch1 and safety input ch2 is different, due to contact failure or short circuit of safety input device(s) or any wiring fault.	
	T7			

Note: At the following, G9SX-LM□ diagnoses the proximity sensors. In that case, it is not abnormal though the operation indicator of the proximity sensor blinks.

- When the rotation of the cogwheel is stopping, and both proximity sensors are turning ON.

Shape of Cogwheel and Setting of Proximity Sensors

1. Installation of proximity sensors

For safe and stable detection of a rotating cogwheel, install proximity sensors according to the following description:

- To avoid interference from surrounding metal and mutual interference, specified proximity sensors should be correctly installed.
- For handling of proximity sensors, see the instruction manual for the E2E.
- Connect two proximity sensors of the same type.
- Install proximity sensors so that one of them is turned ON when the rotation of cogwheel stops.

If neither sensor has detected any movement for one second or longer, G9SX-LM□ will detect it as an error.

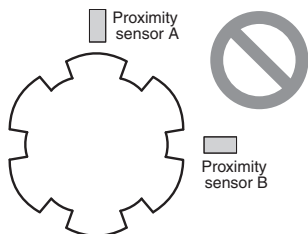

Install proximity sensors so that one of them is turned ON when the rotation of cogwheel stops. Install one proximity sensor on the center line of the concavity width, and the other on the center of the convexity width so that one of the proximity sensors will be turned ON when the rotation of the cogwheel stops.

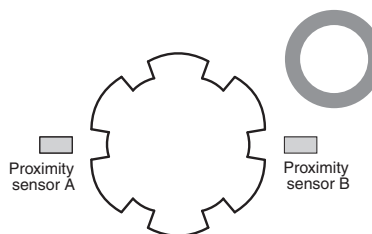

With this installation, both proximity sensors are turned OFF when the rotation of the cogwheel stops. If both sensors are turned OFF for one second or longer, G9SX-LM□ will detect it as an error.

- Make sure the cogwheel and proximity sensors mounted properly and not affected vibration from the machine when it is stop condition; otherwise G9SX-LM□ safety outputs turn off when cogwheel affected machine vibration. Take appropriate measures to keep vibration level to the cogwheel less than or equal to 1Hz.
- G9SX-LM□ diagnoses the proximity sensor at the following condition. The operation indicator on the proximity sensor blinks during this condition.
 - The cogwheel is standstill and both proximity sensor inputs are on status.

2. Relationship between the cogwheel shape and the setting of proximity sensors

Design the cogwheel shape according to types of proximity sensors. Use the following provisions as a reference.

- Proximity sensors to be used should be selected based on the max. number of revolutions during normal operation and the number of cogwheel teeth. See the equation below.

$$R \times 1 / 60 \times N < F$$

R: Max. number of revolutions during normal operation (rpm)

N: Number of cogwheel teeth

F: Response frequency of proximity sensor (Hz)

- Install one proximity sensor on the center line of the concavity width, and the other on the center of the convexity width so that one of the proximity sensors will be turned ON when the rotation of the cogwheel stops.
- All cogwheel teeth should be identically shaped.

The following tables show data for iron cogwheels. Use of other material will show different characteristics of operating range.

See E2E Catalog for details.

"Sensing distance" on the table below shows a size when the proximity sensors are arranged in parallel.

	Shielded	Size	M8	M12	M18
		Model	E2E-X1R5F1□	E2E-X2F1□	E2E-X5F1□
		Sensing distance	1.5 mm	2 mm	5 mm
	①	Distance of convexity	1.2 mm max.	1.6 mm max.	4 mm max.
	②	Distance of concavity	4.5 mm min.	8 mm min.	20 mm min.
	Unshielded	Size	M8	M12	M18
Model		E2E-X2MF1□	E2E-X5MF1□	E2E-X10MF1□	
Sensing distance		2 mm	5 mm	10 mm	
①	Distance of convexity	1.6 mm max.	4 mm max.	8 mm max.	
②	Distance of concavity	8 mm min.	20 mm min.	40 mm min.	

	Shielded	Size	M8	M12	M18
		Model	E2E-X1R5F1□	E2E-X2F1□	E2E-X5F1□
		③	Concavity width	16 mm min.	24 mm min.
	④	Convexity width	Concavity width X 2 min. / Concavity width X 6 max.		
	⑤	Sensing distance	15 mm min.	20 mm min.	35 mm min.
	Unshielded	Size	M8	M12	M18
		Model	E2E-X2MF1□	E2E-X5MF1□	E2E-X10MF1□
		③	Concavity width	24 mm min.	30 mm min.
	④	Convexity width	Concavity width X 2 min. / Concavity width X 6 max.		
⑤	Sensing distance	60 mm min.	100 mm min.	110 mm min.	

3. Design examples

This example shows a design of cogwheel and proximity sensors when the number of motor revolutions of hazards is 3000 rpm at normal operation (high speed), and 60 rpm at low speed.

Step 1: Calculating the number of cogwheel teeth

"Input frequency range" and "Low speed detection settings" of G9SX-LM□ should be considered.

Input frequency range: 1000 max.	Set the number of cogwheel teeth such that the value of the number of rotations at normal operation (high speed) x 1 / 60 x value of the number of cogwheel teeth becomes 1000 max.
Low speed detection settings: 2 to 10 Hz	Set the number of cogwheel teeth such that the value of the number of rotations at low speed x 1 / 60 x value of the number of cogwheel teeth becomes within the range of 2 to 10.

According to the information above, when setting the number of cogwheel teeth at "6," the values will be as mentioned below. These values are frequencies input to rotation detection input of G9SX-LM□, falling within the ranges of "Input frequency range" and "Low speed detection settings".

At normal operation (high speed): $3000 \text{ rpm} \times 1 / 60 \times 6 = 300 \text{ Hz}$

At low speed: $60 \text{ rpm} \times 1 / 60 \times 6 = 6 \text{ Hz}$

Note: When the number of rotations between cogwheel and motor differs due to gear attachment, etc., take its rotation ratio into account.

Step 2: Selecting proximity sensors

Select proximity sensors according to the frequencies obtained in Step 1.

Since the input frequency to G9SX-LM□ at normal operation (high speed) is 300 Hz, select proximity sensors with higher response frequency performance than this value. E2E-X2F1□ (M12 shielded type, Response frequency: 1.5 kHz) is used in this example.

Step 3: Determining the arrangement of proximity sensors for cogwheel

In this example, proximity sensors are installed in the horizontal direction to the cogwheel surface.

Step 4: Determining the distance between cogwheel and proximity sensors

Determine the distance between cogwheel and proximity sensors, and the height of the cogwheel teeth according to "2. Relationship between the cogwheel shape and the setting of proximity sensors".

- Distance of convexity: Design it to be 1.6 mm or less according to the table. In this example, a distance is set to 1 mm (50% of operating range).
- Distance of concavity: Design it to be 8 mm or more according to the table. In this example, the height of the cogwheel is set to 20 mm, making it 21 mm by adding 1 according to "1. Distance of convexity".

Step 5: Determining the widths of convexity and concavity

- Because the number of cogwheel teeth obtained from Step 1 is 6, the angle of the combination of convexity and concavity is: $360^\circ / \text{number of cogwheel teeth} = 60^\circ$.
According to the table of "2. Relationship between the cogwheel shape and the setting of proximity sensors", design the width of convexity as twice as the width of concavity.
Therefore, ratio of an angle of convexity and angle of concavity is set to $2:1 = 40^\circ : 20^\circ$.
- Determine the diameter when concavity is assumed to be a circle.
In this example, set the diameter to 160 mm and verify if it satisfies the provisions of the table in "2. Relationship between the cogwheel shape and the setting of proximity sensors".
According to a. in Step 5, the concavity width is $160 \text{ mm} \times \pi \times 20^\circ / 360^\circ \approx 27.9 \text{ mm}$, satisfying the concavity width of E2E-X2F1□: 24 mm or more.
- Since the height of the cogwheel teeth is set to 20 mm according to Step 4, the diameter of the cogwheel at convexity is to be $160 \text{ mm} + 20 \text{ mm} \times 2 = 200 \text{ mm}$. Verify that it satisfies the provisions of the table in "2. Relationship between the cogwheel shape and the setting of proximity sensors".
According to a. in Step 5, the convexity width is $200 \text{ mm} \times \pi \times 40^\circ / 360^\circ \approx 69.8 \text{ mm}$, satisfying twice or more of the concavity width obtained in b. in Step 5.

Step 6: Determining the thickness of the cogwheel teeth

Determine the thickness according to the shape of the selected proximity sensors. Since the size of E2E-X2F1□ is M12, the thickness of the cogwheel teeth should be 15 mm (standard object width of E2E-X2F1□) to install proximity sensors in the horizontal direction according to Step 3.

According to the process above, an example of shape of cogwheel and arrangement of proximity sensors are shown in the diagram below. Proximity sensors are arranged to be intersecting each other. Note that the distance between proximity sensors defined in the table of "2. Relationship between the cogwheel shape and the setting of proximity sensors" must be satisfied.

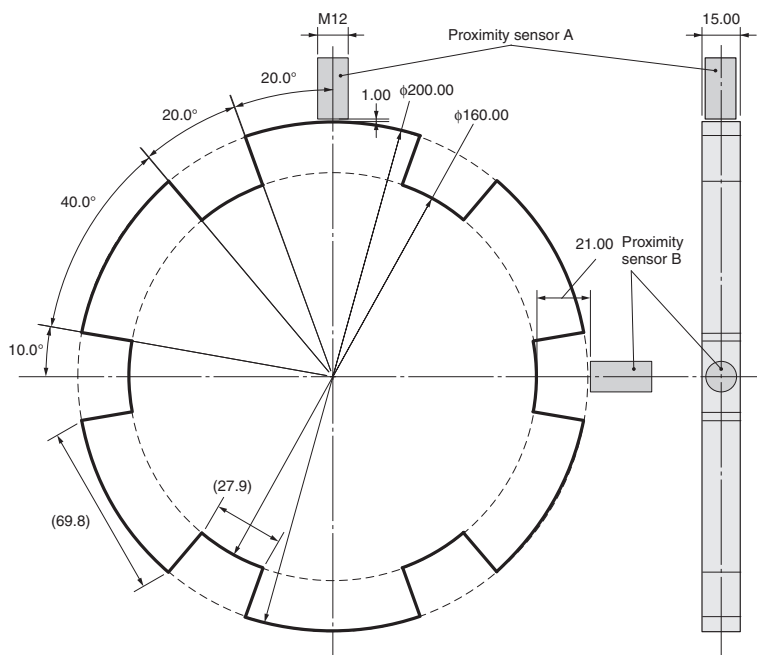

The diagram below shows a design when proximity sensors are installed in the vertical direction to the cogwheel surface.

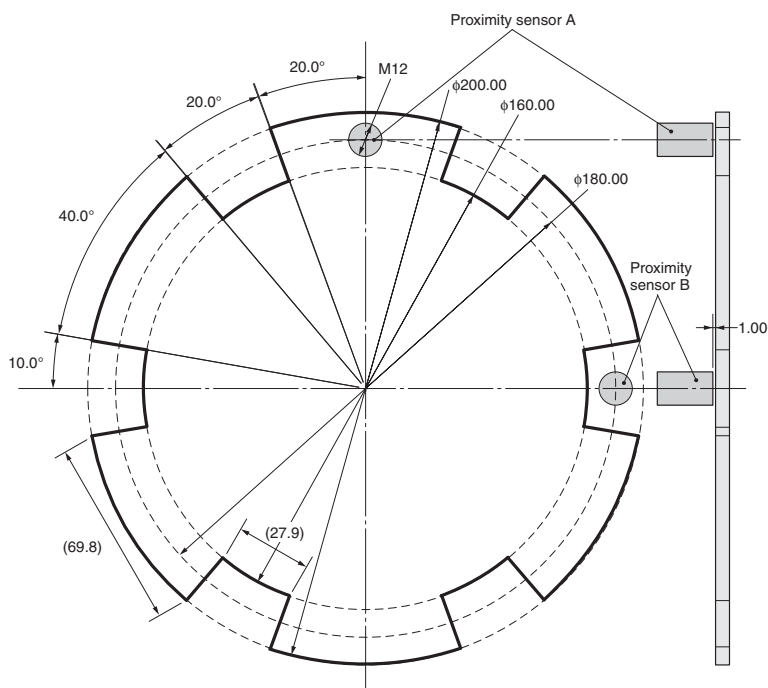

When installing proximity sensors in the vertical direction to the cogwheel surface, note that the height of cogwheel teeth should not be affected by surrounding metal products. For details in influence of surrounding metal, see the E2E Catalog.

4. Example of low speed detection settings

When the number of rotations at low speed is 50 rpm and the number of cogwheel teeth detected by proximity sensors is 6, the frequency at low speed is $50 \text{ rpm} \times 1 / 60 \times 6 = 5 \text{ Hz}$.

Consider the low-speed detection frequency accuracy (tolerance of -10%) such that low speed detection frequency setting is 6.0 Hz or higher.

(1)	(2)	(3)-1	(3)-2
Low speed detection settings (Hz)	Low-speed detection frequency accuracy: Hz $((1) - (1) \times 10\%)$	Safety speed detection outputs are turned ON. No. of revolutions: rpm * No. of cogwheel teeth: $6 ((2) \times 60 / 6)$	Safety speed detection outputs are turned ON. No. of revolutions: rpm * No. of cogwheel teeth: $3 ((2) \times 60 / 3)$
2	1.8	18	36
2.2	1.9	19	38
2.4	2.1	21	42
2.8	2.5	25	50
3.0	2.7	27	54
3.2	2.8	28	56
3.6	3.2	32	64
4.2	3.7	37	74
4.7	4.2	42	84
5.3	4.7	47	94
6.0	5.4	54	108
6.6	5.9	59	118
7.3	6.5	65	130
8.4	7.5	75	150
9.3	8.3	83	166
10	9	90	180

5. Relationship between motor, cogwheel, and hazards

Install the cogwheel between the motor and a hazardous source.

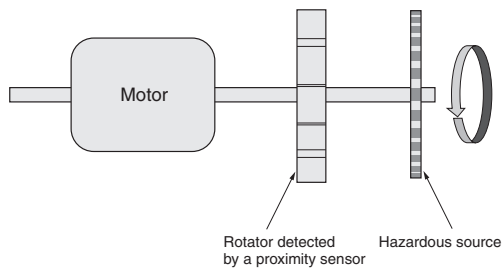

Perform a risk assessment for entire equipment including the conditions of use to implement safety measures.

(For example, attaching a protective cover around a cogwheel)

Dimensions and Terminal Arrangement

Low-speed Monitoring Unit G9SX-LM224-F10-□

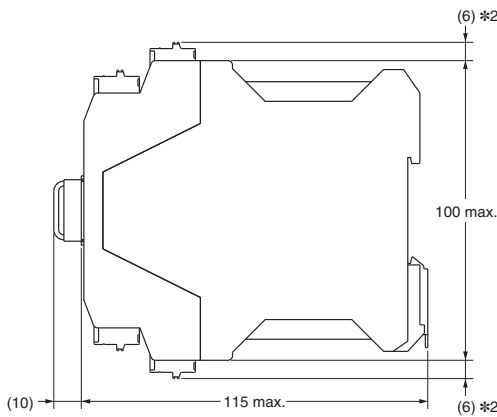
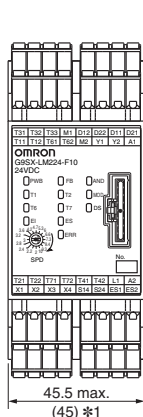
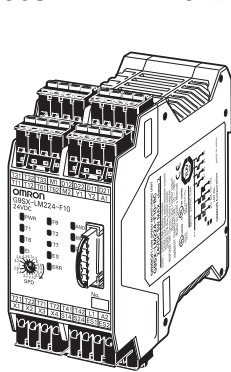

Terminal arrangement

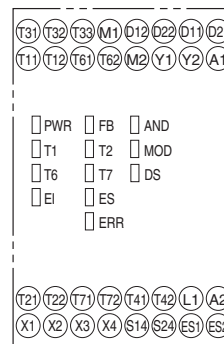

*1 Typical dimension
*2 For -RC terminal type only.

Note: Above outline drawing is for -RC terminal type.

Expansion Unit G9SX-EX401-□

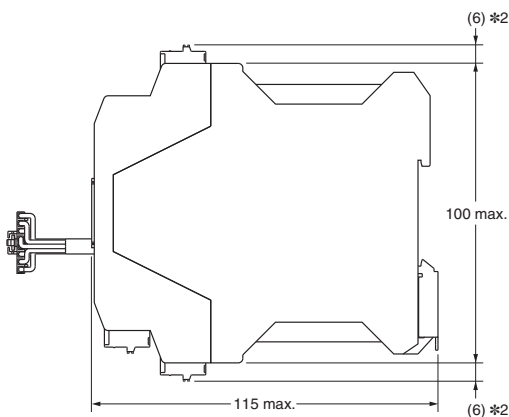
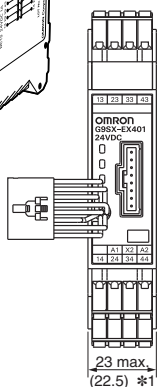
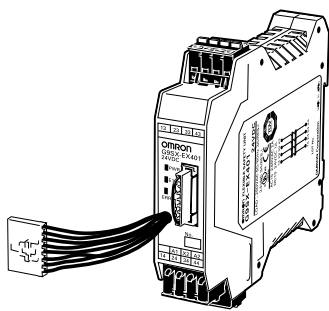

Terminal arrangement

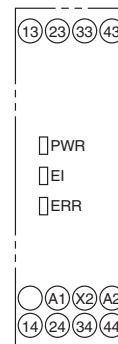







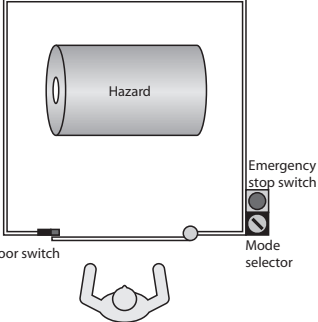

*1 Typical dimension
*2 For -RC terminal type only.

Note: Above outline drawing is for -RC terminal type.

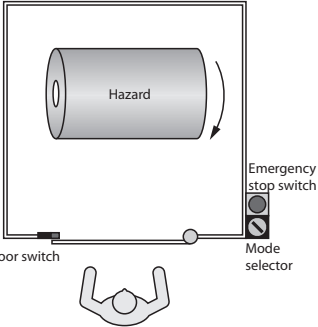

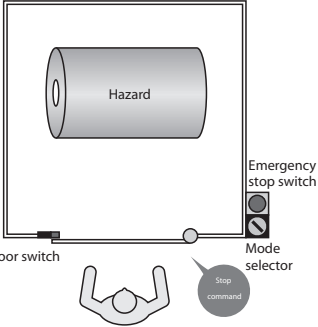

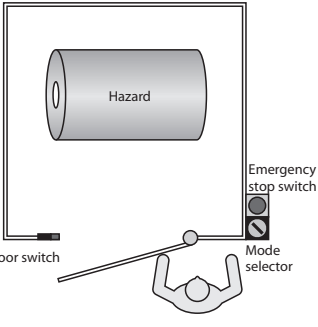

G9SX-LM

Operating Procedure

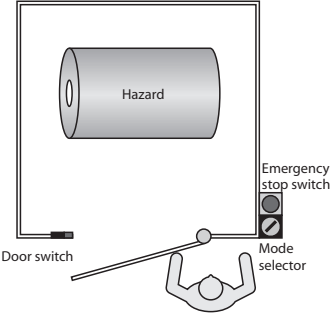
Normal operating mode (M1: ON, M2: OFF)

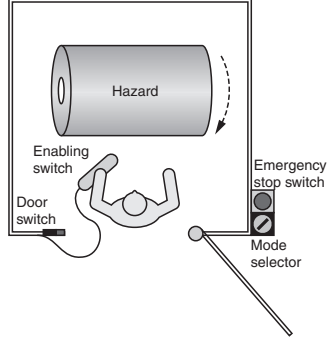
Operating status/operation	LED indicator	Machine operation (status of rotation)	Safety instantaneous output (S14, S24)	Safety speed detection output (ES1, ES2)
<p>Before operation of the equipment (Door closed, reset switch operation)</p> 	<ul style="list-style-type: none"> <input type="checkbox"/> PWR <input type="checkbox"/> FB <input type="checkbox"/> AND <input type="checkbox"/> T1 <input type="checkbox"/> T2 <input type="checkbox"/> MOD <input type="checkbox"/> T6 <input type="checkbox"/> T7 <input type="checkbox"/> DS <input type="checkbox"/> EI <input type="checkbox"/> ES <input type="checkbox"/> ERR 	<p>Standstill</p> 	<p>ON</p>	<p>ON</p>
<p>Operation starts, equipment operates</p> 	<ul style="list-style-type: none"> <input type="checkbox"/> PWR <input type="checkbox"/> FB <input type="checkbox"/> AND <input type="checkbox"/> T1 <input type="checkbox"/> T2 <input type="checkbox"/> MOD <input type="checkbox"/> T6 <input type="checkbox"/> T7 <input type="checkbox"/> DS <input type="checkbox"/> EI <input type="checkbox"/> ES <input type="checkbox"/> ERR 	<p>Rotating</p> 	<p>ON</p>	<p>OFF</p>
<p>Operation stops (door closed)</p> 	<ul style="list-style-type: none"> <input type="checkbox"/> PWR <input type="checkbox"/> FB <input type="checkbox"/> AND <input type="checkbox"/> T1 <input type="checkbox"/> T2 <input type="checkbox"/> MOD <input type="checkbox"/> T6 <input type="checkbox"/> T7 <input type="checkbox"/> DS <input type="checkbox"/> EI <input type="checkbox"/> ES <input type="checkbox"/> ERR 	<p>Standstill</p> 	<p>ON</p>	<p>ON</p>
<p>Operation stops (lock released, door open)</p> 	<ul style="list-style-type: none"> <input type="checkbox"/> PWR <input type="checkbox"/> FB <input type="checkbox"/> AND <input type="checkbox"/> T1 <input type="checkbox"/> T2 <input type="checkbox"/> MOD <input type="checkbox"/> T6 <input type="checkbox"/> T7 <input type="checkbox"/> DS <input type="checkbox"/> EI <input checked="" type="checkbox"/> ES <input type="checkbox"/> ERR 	<p>Standstill</p> 	<p>OFF</p>	<p>ON</p>

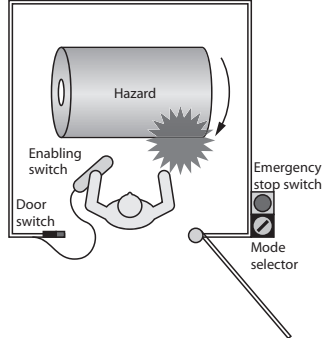
Maintenance mode (M1: OFF, M2: ON)

Operating status/operation	LED indicator	Machine operation (status of rotation)	Safety instantaneous output (S14, S24)	Safety speed detection output (ES1, ES2)
<p>Before starting maintenance (switch to Maintenance mode)</p> 	<p> <input type="checkbox"/> PWR <input type="checkbox"/> FB <input type="checkbox"/> AND <input type="checkbox"/> T1 <input type="checkbox"/> T2 <input checked="" type="checkbox"/> MOD <input type="checkbox"/> T6 <input type="checkbox"/> T7 <input type="checkbox"/> DS <input type="checkbox"/> EI <input checked="" type="checkbox"/> ES <input type="checkbox"/> ERR </p>	<p>Standstill</p> 	<p>OFF</p>	<p>ON</p>
<p>Start maintenance (grip switch ON, reset switch operation, low speed operation)</p> 	<p> <input checked="" type="checkbox"/> PWR <input type="checkbox"/> FB <input type="checkbox"/> AND <input checked="" type="checkbox"/> T1 <input checked="" type="checkbox"/> T2 <input checked="" type="checkbox"/> MOD <input type="checkbox"/> T6 <input type="checkbox"/> T7 <input checked="" type="checkbox"/> DS <input type="checkbox"/> EI <input checked="" type="checkbox"/> ES <input type="checkbox"/> ERR </p>	<p>Decelerating</p> 	<p>ON</p>	<p>ON</p>
<p>Failure occurs (high rotation detected or grip switch is turned OFF)</p> 	<p>When high rotation is detected</p> <p> <input type="checkbox"/> PWR <input type="checkbox"/> FB <input type="checkbox"/> AND <input type="checkbox"/> T1 <input type="checkbox"/> T2 <input checked="" type="checkbox"/> MOD <input type="checkbox"/> T6 <input type="checkbox"/> T7 <input type="checkbox"/> DS <input type="checkbox"/> EI <input type="checkbox"/> ES <input type="checkbox"/> ERR </p> <p>When rotation stops</p> <p> <input checked="" type="checkbox"/> PWR <input type="checkbox"/> FB <input type="checkbox"/> AND <input type="checkbox"/> T1 <input type="checkbox"/> T2 <input checked="" type="checkbox"/> MOD <input type="checkbox"/> T6 <input type="checkbox"/> T7 <input checked="" type="checkbox"/> DS <input type="checkbox"/> EI <input checked="" type="checkbox"/> ES <input type="checkbox"/> ERR </p>	<p>High rotation occurs</p>  <p>↓</p> <p>Standstill</p> 	<p>OFF</p> <p>OFF</p>	<p>OFF</p> <p>ON</p>

Application Examples

Highest achievable PL/safety category	Model	Stop category	Reset
PLd/3 equivalent	Guard Lock Safety Door Switch D4NL/D4SL-N/D4JL (mechanical lock type) Safety Limit Switch D4N/D4F Enabling Grip Switch A4EG Safety Key Selector Switch A22TK-□-11-□□ Proximity Sensor E2E-X1R5F1 / E2E-X2F1 / E2E-X5F1 / E2E-X2MF1 / E2E-X5MF1 / E2E-X10MF1 Low Speed Detection Unit G9SX-LM224-F10	0 or 1	Manual

Note: The above PL is only the evaluation result of the example. The PL must be evaluated in an actual application by the customer after confirming the usage conditions.

●Application Overview

1. Normal operating mode (safety input enabled)

- When normal operating mode (M1 = ON, M2 = OFF) is selected on the selector switch S6, the motor M rotates according to the operation command of the motor controller while the guard is closed.
- When the motor stopping command is input to the motor controller, the motor M starts stopping the rotation. When the pulse signal from the proximity sensor that detects rotation is 2 Hz or less, the safety speed detecting output (ES1) turns ON, enabling the lock release. When the lock release switch S4 is pressed, the guard lock is released and the guard is opened.
- Opening of the guard is detected by S1 and S2, and the power supply to the motor M is turned OFF immediately.
- The power supply to the motor M is kept OFF until the guard is closed and the reset switch S3 is pressed.

2. Maintenance mode (enabling input enabled)

- Lock release is enabled when maintenance mode (M1 = OFF, M2 = ON) is selected by the selector switch S6 and safety speed detection output (ES1) is ON. When the lock release switch S4 is pressed, the guard lock is released and the guard is opened.
- The power supply to the motor M is turned ON when the enabling switch S5 is gripped to the middle position and the reset switch S3 is pressed.
- If the enabling switch S5 is released or gripped past the middle position, or if the pulse signal from the proximity sensor exceeds the low speed detection frequency set value, the power supply to the motor M is turned OFF immediately.
- The power supply to the motor M2 is kept OFF until the enabling switch is gripped again to the middle position and the pulse signal from the proximity sensor reaches the low speed detection frequency set value or less and the reset switch S3 is pressed.

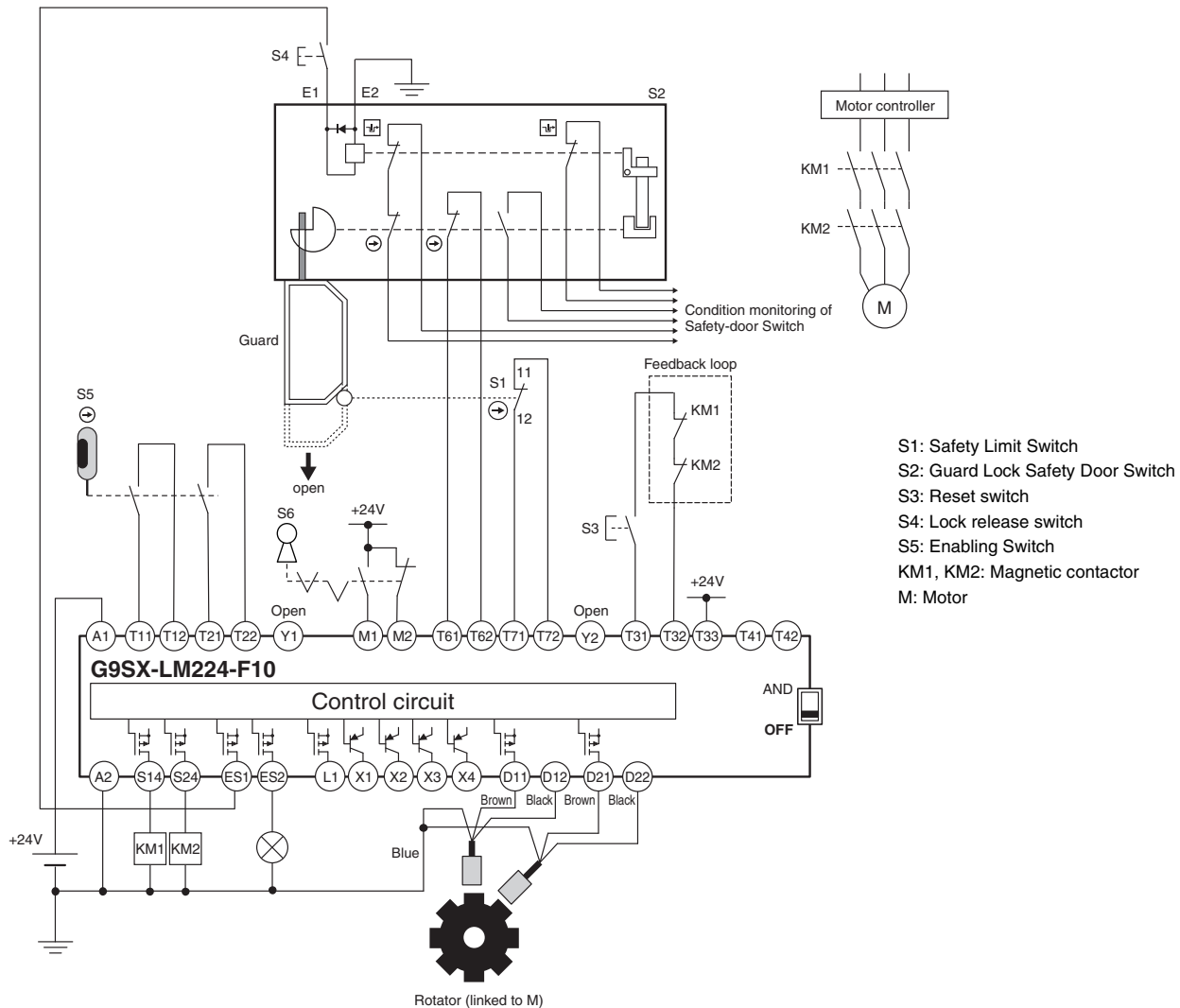

Timing Chart for Normal Operating Mode (M1: ON, M2: OFF)

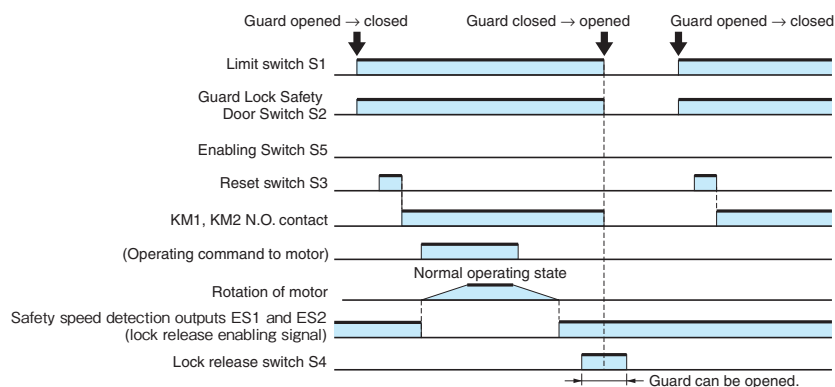

Timing Chart for Maintenance Mode (M1: OFF, M2: ON)

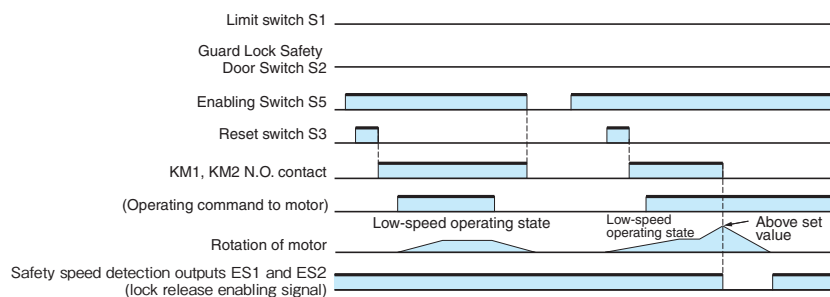



Precautions

Be sure to read the Common Precautions for Safety Warning at the following URL: <http://www.ia.omron.com/>.

 **WARNING**

Serious injury may possibly occur due to breakdown of safety outputs.
Do not connect loads beyond the rated value to the safety outputs. 

Serious injury may possibly occur due to loss of required safety functions.
Wire G9SX-LM□ properly so that supply voltages or voltages for loads do NOT touch the safety inputs accidentally or unintentionally. 

Serious injury may possibly occur due to damages of safety inputs.
Apply protection circuitry against back electromotive force in case connecting inductive loads to safety outputs. 

Serious injury may possibly occur due to loss of safety functions.
Connect specified proximity sensors to the Rotation detection inputs. 
Cogwheel must be correctly designed and installed based on specifications of selected proximity sensors according to page 13 'Shape of Cogwheel and Setting of Proximity Sensors' in the operating instruction and other operation manuals or related documents supplied with the sensors. After installation of the Cogwheel, check the operation of the system before use.

Serious injury may possibly occur due to loss of required safety functions.
To avoid interference from surrounding metal and mutual interference, specified proximity sensors must be correctly designed and installed according to page 13 'Shape of Cogwheel and Setting of Proximity Sensors' and operation manuals or related documents attached to the proximity sensors. 

Serious injury may possibly occur due to loss of safety functions.
Use appropriate devices referring to the information provided on the right table. 

Controlling Devices	Requirements
Safety Door Switches Safety Limit Switches	Use approved devices with Direct Opening Mechanism complying with IEC/EN 60947-5-1 and capable of switching micro loads of 24 VDC, 5mA.
Enabling Switches	Use approved devices complying with IEC/EN 60947-5-1. Use devices with contacts capable of switching micro loads of 24VDC, 5mA.
Safety Sensors	Use approved devices complying with the relevant product standards, regulations and rules in the country where it is used. Consult a certification body to assess that the entire system satisfies the required safety category level.
Proximity Sensors	Use the following OMRON E2E series, three-wire DC sensors (PNP). E2E-X1R5F1□ E2E-X2MF1□ E2E-X2F1□ E2E-X5MF1□ E2E-X5F1□ E2E-X10MF1□
Safety Relays	Use approved devices with forcibly guided contacts complying with EN 50205 (IEC/EN61810-3). For feedback purpose use devices with contacts capable of switching micro loads of 24VDC, 5mA.
Contactors	Use approved devices complying with IEC/EN 60947-4-1 for auxiliary contact linked with power contact (mirror contact). For feedback purpose use devices with contacts capable of switching micro loads of 24VDC, 5mA.
Emergency Stop Switches	Do not connect an emergency stop switch to G9SX-LM□.
Other devices	Evaluate whether devices used are appropriate to satisfy the requirements of safety category level.

Precautions for Safe Use

1. Use G9SX-LM□ within an enclosure with IP54 protection or higher of IEC/EN60529.
2. Incorrect wiring may lead to loss of safety function. Wire conductors correctly and verify the operation of G9SX-LM□ before commissioning the system in which G9SX-LM□ is incorporated.
3. Do not apply DC voltages exceeding the rated voltages, or any AC voltages to the G9SX-LM□ power supply input.
4. Use DC supply satisfying requirements below to prevent electric shock.
 - DC power supply with double or reinforced insulation, for example, according to IEC/EN60950 or EN50178 or a transformer according to IEC/EN61558.
 - DC supply satisfies the requirement for class 2 circuits or limited voltage/current circuit stated in UL 508.
5. Apply properly specified voltages to G9SX-LM□ inputs. Applying inappropriate voltages cause G9SX-LM□ to fail to perform its specified function, which leads to the loss of safety functions or damages to G9SX-LM□.
6. Be sure to correctly connect safety input devices to safety input and enabling input to ensure proper operation of the safety function.
7. The auxiliary error output, auxiliary monitoring output are NOT safety outputs.
Do not use auxiliary outputs as any safety output. Such incorrect use causes loss of safety function of G9SX-LM□ and its relevant system. Also Logical connection outputs can be used only for logical connections between G9SXs.
8. After installation of G9SX-LM□, qualified personnel should confirm the installation, and should conduct test operations and maintenance. The qualified personnel should be qualified and authorized to secure the safety on each phases of design, installation, running, maintenance and disposal of system.
9. A person in charge, who is familiar to the machine in which G9SX-LM□ is to be installed, should conduct and verify the installation.
10. Mode selector switch should be operated only by qualified personnel who is familiar to the machine. For example to avoid unauthorized personnel's unexpected operation of mode selector switch, use a selector switch with locking-key. The machine should be stopped before the Mode selector inputs are switched.
11. Perform daily and 6-month inspections for the G9SX-LM□. Otherwise, the system may fail to work properly, resulting in serious injury.
12. Do not dismantle, repair, or modify G9SX-LM□. It may lead to loss of its safety functions.
13. Conformity to IEC/EN 61508 SIL3, IEC/EN62061 SIL3 and ISO13849-1 PLd was assessed with G9SX-LM□ alone. And conformity to EN954-1 Safety Category 3 was assessed with G9SX-LM□ set up with specified proximity sensors. Use only appropriate components or devices complying with relevant safety standards corresponding to the required level of safety categories. Conformity to requirements of safety category is determined as an entire system. It is recommended to consult a certification body regarding assessment of conformity to the required safety level.
14. OMRON shall not be responsible for conformity with any safety standards regarding to customer's entire system.
15. Disconnect G9SX-LM□ from power supply when wiring. Devices connected to G9SX-LM□ may operate unexpectedly.
16. Be cautious not to have your fingers caught when attaching terminal sockets to the plugs on G9SX-LM□.
17. Do not use in combustible gases or explosive gases.
18. Proximity sensors to be used should be selected based on the max. number of revolutions during normal operation and the number of cogwheel teeth. Please refer to the equation below;

$$R \times 1/60 \times N < F$$
 - R : Max. number of revolutions during normal operation (rpm)
 - N : Number of cogwheel teeth
 - F : Response frequency of Proximity Sensor (Hz)

Precautions for Correct Use

1. Handle with care
Do not drop G9SX-LM□ to the ground or expose to excessive vibration or mechanical shocks. G9SX-LM□ may be damaged and may not function properly.
2. Conditions of storage and usage
Do not store or use in such conditions stated below.
 - a. In direct sunlight
 - b. At ambient temperatures out of the range of -10 to 55 °C
 - c. At relative humidity out of the range of 25% to 85% or under such temperature change that causes condensation.
 - d. In corrosive or combustible gases
 - e. With vibration or mechanical shocks out of the rated values.
 - f. Under splashing of water, oil, chemicals
 - g. In the atmosphere containing dust, saline or metal powder.
G9SX-LM□ may be damaged and may not function properly.
3. Mounting
Mount G9SX to DIN rails with attachments (TYPE PFP-M, not incorporated to this product), not to drop out of rails by vibration etc. especially when the length of DIN railing is short compared to the widths of G9SX.
Do not use G9SX-LM□ at altitudes over 1,000 meters.
4. Following spacing around G9SX should be available to apply rated current to outputs of G9SX and for enough ventilation and wiring:
 - a. At least 25 mm beside side faces of G9SX-LM□.
 - b. At least 50 mm above top face of G9SX-LM□ and below bottom face of G9SX-LM□.

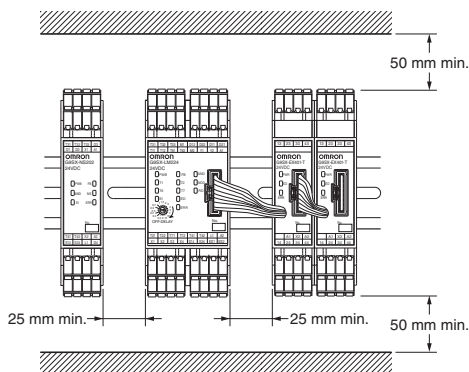

5. Wiring
 - a. G9SX-LM224-F10-□
 - Use the following to wire to G9SX-LM□.

Solid wire	0.2 to 2.5mm ² AWG24 to AWG12
Stranded wire (Flexible wire)	0.2 to 2.5mm ² AWG24 to AWG12

- Strip the cover of wire no longer than 7mm.
- b. G9SX-LM224-F10-RT (with screw terminals)
Tighten each screw with a specified torque of 0.5 to 0.6N·m, or the G9SX-LM□ may malfunction or generate heat.
 - c. Logical AND Connection
Use VCTF cable or shielded cable for Logical AND connection between units.
6. When connecting Expansion Units (G9SX-EX□-□) to G9SX-LM224-F10-□:
 - 1) Follow the procedure below:
 - a. Remove the termination connector from the receptacle on G9SX-LM224-F10-□.
 - b. Insert the head of the connecting cable of Expansion Unit to the receptacle on the G9SX-LM224-F10-□.
 - c. Set the termination connector to the receptacle on the Expansion Unit at the end position. When G9SX-LM224-F10-□ is used without expansion units, leave the termination connector set on the G9SX-LM224-F10-□.
 - 2) Do not remove the termination connector while the system is operating.
 - 3) Before applying supply voltage, confirm that the connecting sockets and plugs are locked firmly.
 - 4) All of the Expansion Units should be supplied with its specified voltages within 10s after the connected G9SX-LM224-F10-□ is supplied with voltage. Otherwise, G9SX-LM224-F10-□ detects the power-supply error for the Expansion Units. Follow the procedure below:
 7. Use 1NO1NC contact switch as a mode selector switch.
 8. Use cables with length less than 100m to connect to Safety inputs, Enabling inputs, Mode selector inputs, Feed-back/Reset inputs, or between Logical AND connection inputs and Logical connection outputs, respectively.
 9. Use cables with length less than 100m to connect to proximity sensor.
 10. Set the time duration of low-speed detection frequency to an appropriate value that does not cause the loss of safety function of system.
 11. Use specified cogwheels to firmly fix proximity sensors so as to prevent the sensors from dropping off.
(Refer to **page 13** "Shape of Cogwheel and Setting for Proximity Sensors".

12. Logical connection between Units:
- When using Logical AND connection inputs, set the Logical connection preset switch to 'AND' position for the units which the logical connection signal are input to.
 - Connect Logical connection outputs appropriately to Logical AND connection inputs of the relevant unit. Verify the operation of G9SX-LM□ before commissioning the system.
 - When configuring the safety related system, be sure to consider that the delay of response time caused by logical connections do not degrade the safety function of the system.
13. To determine safety distance to hazards, take into account the delay of Safety outputs caused by the following time:
- Response time of Safety inputs
 - Response time of Logical AND connection input
(See also "Characteristics" on page 3.)
14. Start entire system after more than 5s have passed since applying supply voltage to all G9SXs in the system.
15. G9SX-LM□ may malfunction due to electro-magnetic disturbances. Be sure to connect the terminal A2 to ground. When using a DC power supply with light curtains, use DC power supply which has no interruption by a power failure of 20ms. Connect surge suppressors to both ends of coils of an inductive load to suppress noise.
16. This is a class A product. In residential areas it may cause radio interference, in which case the user may be required to take adequate measures to reduce interference.
17. Devices connected to G9SX-LM□ may operate unexpectedly. When replacing G9SX-LM□, disconnect it from power supply.
18. Adhesion of solvent such as alcohol, thinner, trichloroethane or gasoline on the product should be avoided. Such solvents make the marking on G9SX-LM□ illegible and cause deterioration of parts.
19. Do not use a CR type of surge suppressor for the inductive load connected to an instantaneous safety output. This may cause failure or malfunction. It is recommended to use a diode+Zener-diode type of surge suppressor for an application for which a response time needs to be allowed.
20. When reversing the rotation direction of the hazard source during low-speed operation, allow the hazard source to stop for 500ms or longer before changing the rotation direction. Reversing the rotation direction without providing for stoppage time may result in the safety outputs of G9SX-LM□ being turned OFF.
21. Do NOT mix AC load and DC load to be switched in one G9SX-EX□-□. When switching of both AC load and DC load is necessary, connect more than two G9SX-EX□-□ and use each unit for AC load and DC load exclusively.

Safety Category (ISO13849-1)

G9SX-LM□ can be applied to the environment of PLd/Safety Category 3 required by ISO13849-1.

However, please note that this does not mean that G9SX can be always used for this category under all similar conditions or situations. Be sure to assess the entire system for conformity to a required category before use.

For conformity to Safety Category 3 (ISO13849-1, EN 954-1), please check the following points;

- Use both of the two channels for Enabling inputs (T11-T12, T21-22), Safety inputs (T61-62, T71-T72), and Rotation detection inputs (D11-D12, D21-D22).
- Use direct opening action switches for safety inputs (T61-T62, T71-T72). When limit switches are used, at least one of them should be a direct opening action limit switch. When connecting a Safety Sensor to the G9SX-LM□, use a TYPE3 or 4 Safety Sensor.
- Use an enabling device, such as grip-switch, for Enabling inputs (T11-T12, T21-T22)
- Connect specified Proximity sensors to Rotation detection inputs (D11-D12, D21-D22)
- Apply input signals to T31-T32 for manual reset, or T31-T33 for auto-reset, through the N.C. contact. (Refer to "Application Examples" on page 20.)
- Be sure to connect A2 to ground.

Compliance with International Standards

G9SX-LM224-F10-□

- Certified by TÜV SÜD
EN954-1 Cat.3
IEC/EN61508 SIL3
IEC/EN62061 SIL3
ISO13849-1 PLd/Safety Category 3
EN1088
EN50178
IEC/EN60204-1
EN ISO14119
- Certified by UL
UL508
CAN/CSA C22.2 No.142