



Chipsmall Limited consists of a professional team with an average of over 10 year of expertise in the distribution of electronic components. Based in Hongkong, we have already established firm and mutual-benefit business relationships with customers from,Europe,America and south Asia,supplying obsolete and hard-to-find components to meet their specific needs.

With the principle of “Quality Parts,Customers Priority,Honest Operation,and Considerate Service”,our business mainly focus on the distribution of electronic components. Line cards we deal with include Microchip,ALPS,ROHM,Xilinx,Pulse,ON,Everlight and Freescale. Main products comprise IC,Modules,Potentiometer,IC Socket,Relay,Connector.Our parts cover such applications as commercial,industrial, and automotives areas.

We are looking forward to setting up business relationship with you and hope to provide you with the best service and solution. Let us make a better world for our industry!



## Contact us

Tel: +86-755-8981 8866 Fax: +86-755-8427 6832

Email & Skype: info@chipsmall.com Web: www.chipsmall.com

Address: A1208, Overseas Decoration Building, #122 Zhenhua RD., Futian, Shenzhen, China



# GD SERIES

Related Information

■ General terms and conditions..... F-7

■ General precautions.....P.1501



[panasonic.net/id/pidsx/global](http://panasonic.net/id/pidsx/global)

## From ultra-thin lead frames to iron sheets... Double feed detection of various metal sheets

### Double metal sheets detected

The high-end GD sensing technology detects double feeds of any metal sheet 0.01 mm **0.0004 in**, or more, thick.

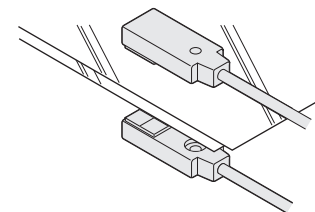

### Easy sensitivity setting with actual samples

Optimum sensitivity setting is easy by using the teaching function with actual samples.

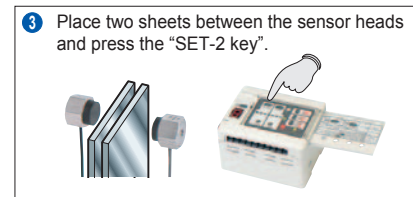
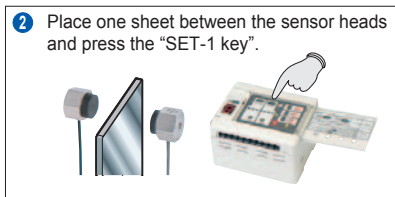
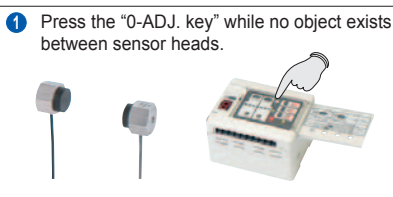

## VARIETIES

### Three types of sensor heads for various objects

#### Small object detection sensor head / GD-3

This is an extremely small sensor head, only  $\varnothing 3.8 \times 15$  mm  $\varnothing 0.150 \times 0.591$  in, suitable for detecting small components.

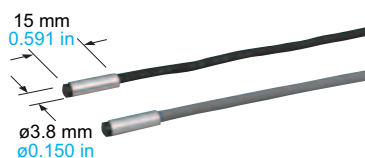

#### High precision sensor head / GD-10

It is suitable for high precision detection of double feeds of lead frames or thin metal sheets.

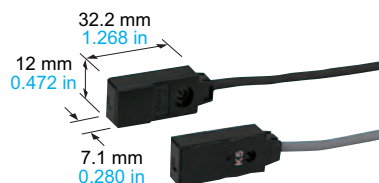

#### Long sensing range sensor head / GD-20

It achieves a long sensing range of 70 mm **2.756 in**. Further, it employs a robust metal case with IP67 protection to withstand harsh environment.

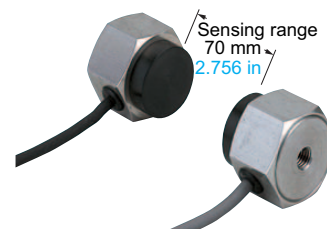

- Selection Guide
- Laser Displacement
- Magnetic Displacement
- Collimated Beam
- Digital Panel Controller
- Metal-sheet Double-feed Detection



**APPLICATIONS**

**Detecting overlap of washers**  
**GD-3** detects an overlap of small components such as washers.

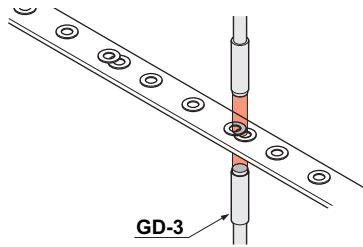

**Detecting double feeds of lead frames**  
 The high precision sensor head **GD-10** does not miss double feeds of lead frames even if they are very thin and highly perforated.

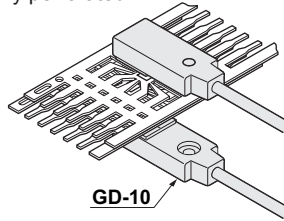

**Detecting double feeds of sheet metal**  
 The long sensing range sensor head **GD-20** allows the object thickness to be as much as 10 mm 0.394 in. Hence, various objects can be detected.

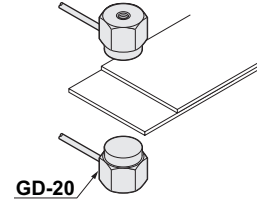

**Detecting seam of hoop material**  
 Even a minute difference in thickness can be detected.

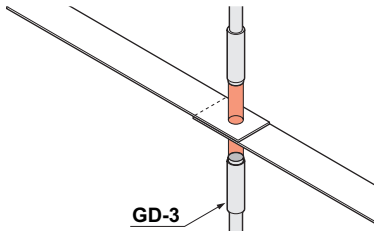

**Detecting double feeds of aluminum foils**  
**GD-10** can detect double feeds of thin aluminum foils which are several tens of micrometer thick.

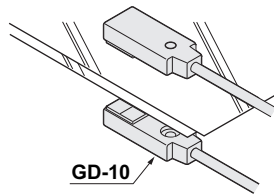

**Detecting missing tablet package in box**  
**GD-20** can check if each box contains a given number of aluminum tablet packages. Since **GD-20** has a sensing range of up to 70 mm 2.756 in, thick boxes can pass through the sensor heads.

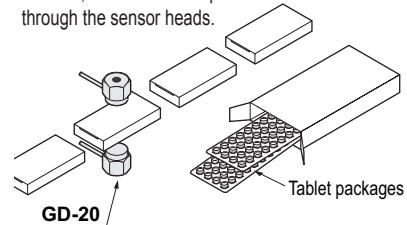

**FUNCTIONS**

**Seven LEDs indicate the sensing level**

The optimum sensing point can be confirmed at a glance as seven LEDs indicate the sensing level.

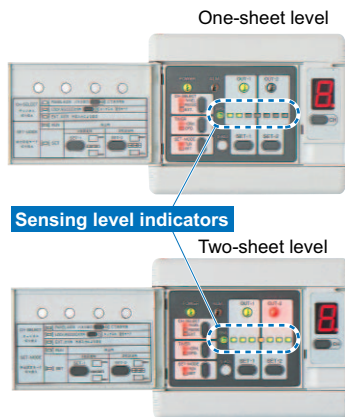

**Suitable for flexible manufacturing**

Since sensitivities of eight channels can be stored, product changeover is smooth and easy. Select channel number by the "Channel shift key" on the operation panel or by using external channel select inputs. Further, since **GD-C2** is equipped with RS-232C communication function, the sensitivity values can be stored in a personal computer, etc., and fed into the controller as per requirement.

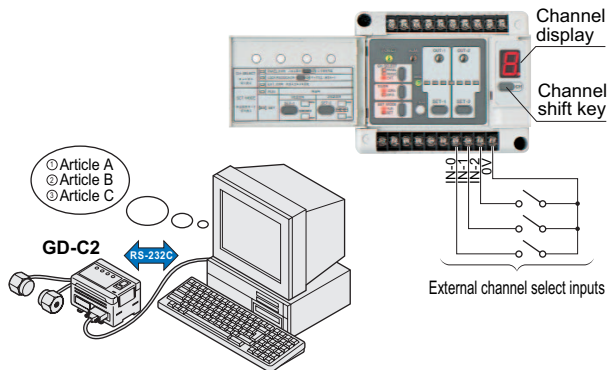

**Two-sheet threshold level shift function**

The two-sheet threshold level set by teaching can be shifted in nine steps to suit the detection conditions. This enables very stable detection.

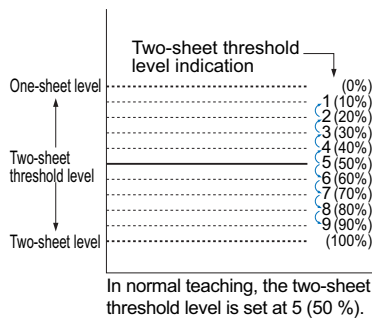

**External initialization**

Teaching is possible by external devices, such as, PLC, etc. This enhances productivity by machine automation.

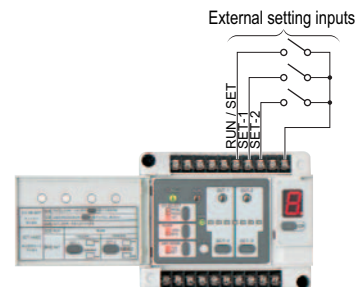

FIBER SENSORS

LASER SENSORS

PHOTOELECTRIC SENSORS

MICRO PHOTOELECTRIC SENSORS

AREA SENSORS

LIGHT CURTAINS / SAFETY COMPONENTS

PRESSURE / FLOW SENSORS

INDUCTIVE PROXIMITY SENSORS

PARTICULAR USE SENSORS

SENSOR OPTIONS

SIMPLE WIRE-SAVING UNITS

WIRE-SAVING SYSTEMS

MEASUREMENT SENSORS

STATIC ELECTRICITY PREVENTION DEVICES

LASER MARKERS

PLC

HUMAN MACHINE INTERFACES

ENERGY CONSUMPTION VISUALIZATION COMPONENT

FA COMPONENTS

MACHINE VISION SYSTEMS

UV CURING SYSTEMS

Selection Guide

Laser Displacement

Magnetic Displacement

Collimated Beam

Digital Panel Controller

Metal-sheet Double-feed Detection

**GD**

**ORDER GUIDE**

**Sensor heads**

Type	Appearance	Sensing range (between sensor heads)	Detectable sheet thickness	Model No.	Applicable controllers																																																						
Small object detection		10 mm <b>0.394 in</b>	Standard sensing object size: 20 × 20 mm <b>0.787 × 0.787 in</b>	<b>GD-3</b>	<b>GD-C3</b>																																																						
			<table border="1"> <thead> <tr> <th>Material</th> <th>Setting distance</th> <th>5 mm <b>0.197 in</b></th> <th>10 mm <b>0.394 in</b></th> </tr> </thead> <tbody> <tr> <td>Iron (SPCC)</td> <td>0.01 to 0.1 mm</td> <td><b>0.0004 to 0.004 in</b></td> <td>0.03 to 0.1 mm <b>0.001 to 0.004 in</b></td> </tr> <tr> <td>Aluminum</td> <td>0.015 to 1 mm</td> <td><b>0.001 to 0.039 in</b></td> <td>0.015 to 1 mm <b>0.001 to 0.039 in</b></td> </tr> <tr> <td>Copper</td> <td>0.018 to 1 mm</td> <td><b>0.001 to 0.039 in</b></td> <td>0.018 to 0.3 mm <b>0.001 to 0.012 in</b></td> </tr> <tr> <td>Brass</td> <td>0.03 to 1 mm</td> <td><b>0.001 to 0.039 in</b></td> <td>0.03 to 0.5 mm <b>0.001 to 0.020 in</b></td> </tr> <tr> <td>Stainless steel (SUS304)</td> <td>0.3 to 1 mm</td> <td><b>0.012 to 0.039 in</b></td> <td>0.3 to 1 mm <b>0.012 to 0.039 in</b></td> </tr> </tbody> </table>			Material	Setting distance	5 mm <b>0.197 in</b>	10 mm <b>0.394 in</b>	Iron (SPCC)	0.01 to 0.1 mm	<b>0.0004 to 0.004 in</b>	0.03 to 0.1 mm <b>0.001 to 0.004 in</b>	Aluminum	0.015 to 1 mm	<b>0.001 to 0.039 in</b>	0.015 to 1 mm <b>0.001 to 0.039 in</b>	Copper	0.018 to 1 mm	<b>0.001 to 0.039 in</b>	0.018 to 0.3 mm <b>0.001 to 0.012 in</b>	Brass	0.03 to 1 mm	<b>0.001 to 0.039 in</b>	0.03 to 0.5 mm <b>0.001 to 0.020 in</b>	Stainless steel (SUS304)	0.3 to 1 mm	<b>0.012 to 0.039 in</b>	0.3 to 1 mm <b>0.012 to 0.039 in</b>																														
Material	Setting distance	5 mm <b>0.197 in</b>	10 mm <b>0.394 in</b>																																																								
Iron (SPCC)	0.01 to 0.1 mm	<b>0.0004 to 0.004 in</b>	0.03 to 0.1 mm <b>0.001 to 0.004 in</b>																																																								
Aluminum	0.015 to 1 mm	<b>0.001 to 0.039 in</b>	0.015 to 1 mm <b>0.001 to 0.039 in</b>																																																								
Copper	0.018 to 1 mm	<b>0.001 to 0.039 in</b>	0.018 to 0.3 mm <b>0.001 to 0.012 in</b>																																																								
Brass	0.03 to 1 mm	<b>0.001 to 0.039 in</b>	0.03 to 0.5 mm <b>0.001 to 0.020 in</b>																																																								
Stainless steel (SUS304)	0.3 to 1 mm	<b>0.012 to 0.039 in</b>	0.3 to 1 mm <b>0.012 to 0.039 in</b>																																																								
High precision		30 mm <b>1.181 in</b>	Standard sensing object size: 80 × 80 mm <b>3.150 × 3.150 in</b>	<b>GD-10</b>	<b>GD-C1 GD-C2 GD-C3</b>																																																						
			<table border="1"> <thead> <tr> <th rowspan="2">Material</th> <th colspan="2">Setting distance</th> <th>20 mm <b>0.787 in</b></th> <th>30 mm <b>1.181 in</b></th> </tr> <tr> <th colspan="2">Applicable controllers</th> <th></th> <th></th> </tr> </thead> <tbody> <tr> <td rowspan="2">Iron (SPCC)</td> <td><b>GD-C1/C2</b></td> <td>0.07 to 1 mm</td> <td><b>0.003 to 0.039 in</b></td> <td>0.07 to 0.5 mm <b>0.003 to 0.020 in</b></td> </tr> <tr> <td><b>GD-C3</b></td> <td>0.01 to 0.3 mm</td> <td><b>0.0004 to 0.012 in</b></td> <td>0.01 to 0.1 mm <b>0.0004 to 0.004 in</b></td> </tr> <tr> <td rowspan="2">Aluminum</td> <td><b>GD-C1/C2</b></td> <td>0.03 to 6 mm</td> <td><b>0.001 to 0.236 in</b></td> <td>0.03 to 2 mm <b>0.001 to 0.079 in</b></td> </tr> <tr> <td><b>GD-C3</b></td> <td>0.015 to 1 mm</td> <td><b>0.001 to 0.039 in</b></td> <td>0.015 to 1 mm <b>0.001 to 0.039 in</b></td> </tr> <tr> <td rowspan="2">Copper</td> <td><b>GD-C1/C2</b></td> <td>0.03 to 6 mm</td> <td><b>0.001 to 0.236 in</b></td> <td>0.03 to 2 mm <b>0.001 to 0.079 in</b></td> </tr> <tr> <td><b>GD-C3</b></td> <td>0.018 to 1 mm</td> <td><b>0.001 to 0.039 in</b></td> <td>0.018 to 1 mm <b>0.001 to 0.039 in</b></td> </tr> <tr> <td rowspan="2">Brass</td> <td><b>GD-C1/C2</b></td> <td>0.03 to 6 mm</td> <td><b>0.001 to 0.236 in</b></td> <td>0.03 to 2 mm <b>0.001 to 0.079 in</b></td> </tr> <tr> <td><b>GD-C3</b></td> <td>0.01 to 1 mm</td> <td><b>0.0004 to 0.039 in</b></td> <td>0.01 to 1 mm <b>0.0004 to 0.039 in</b></td> </tr> <tr> <td rowspan="2">Stainless steel (SUS304)</td> <td><b>GD-C1/C2</b></td> <td>0.1 to 6 mm</td> <td><b>0.004 to 0.236 in</b></td> <td>0.1 to 2 mm <b>0.004 to 0.079 in</b></td> </tr> <tr> <td><b>GD-C3</b></td> <td>0.05 to 2 mm</td> <td><b>0.002 to 0.079 in</b></td> <td>0.05 to 1 mm <b>0.002 to 0.039 in</b></td> </tr> </tbody> </table>			Material	Setting distance		20 mm <b>0.787 in</b>	30 mm <b>1.181 in</b>	Applicable controllers				Iron (SPCC)	<b>GD-C1/C2</b>	0.07 to 1 mm	<b>0.003 to 0.039 in</b>	0.07 to 0.5 mm <b>0.003 to 0.020 in</b>	<b>GD-C3</b>	0.01 to 0.3 mm	<b>0.0004 to 0.012 in</b>	0.01 to 0.1 mm <b>0.0004 to 0.004 in</b>	Aluminum	<b>GD-C1/C2</b>	0.03 to 6 mm	<b>0.001 to 0.236 in</b>	0.03 to 2 mm <b>0.001 to 0.079 in</b>	<b>GD-C3</b>	0.015 to 1 mm	<b>0.001 to 0.039 in</b>	0.015 to 1 mm <b>0.001 to 0.039 in</b>	Copper	<b>GD-C1/C2</b>	0.03 to 6 mm	<b>0.001 to 0.236 in</b>	0.03 to 2 mm <b>0.001 to 0.079 in</b>	<b>GD-C3</b>	0.018 to 1 mm	<b>0.001 to 0.039 in</b>	0.018 to 1 mm <b>0.001 to 0.039 in</b>	Brass	<b>GD-C1/C2</b>	0.03 to 6 mm	<b>0.001 to 0.236 in</b>	0.03 to 2 mm <b>0.001 to 0.079 in</b>	<b>GD-C3</b>	0.01 to 1 mm	<b>0.0004 to 0.039 in</b>	0.01 to 1 mm <b>0.0004 to 0.039 in</b>	Stainless steel (SUS304)	<b>GD-C1/C2</b>	0.1 to 6 mm	<b>0.004 to 0.236 in</b>	0.1 to 2 mm <b>0.004 to 0.079 in</b>	<b>GD-C3</b>	0.05 to 2 mm	<b>0.002 to 0.079 in</b>	0.05 to 1 mm <b>0.002 to 0.039 in</b>
			Material				Setting distance		20 mm <b>0.787 in</b>	30 mm <b>1.181 in</b>																																																	
						Applicable controllers																																																					
			Iron (SPCC)			<b>GD-C1/C2</b>	0.07 to 1 mm	<b>0.003 to 0.039 in</b>	0.07 to 0.5 mm <b>0.003 to 0.020 in</b>																																																		
						<b>GD-C3</b>	0.01 to 0.3 mm	<b>0.0004 to 0.012 in</b>	0.01 to 0.1 mm <b>0.0004 to 0.004 in</b>																																																		
			Aluminum			<b>GD-C1/C2</b>	0.03 to 6 mm	<b>0.001 to 0.236 in</b>	0.03 to 2 mm <b>0.001 to 0.079 in</b>																																																		
						<b>GD-C3</b>	0.015 to 1 mm	<b>0.001 to 0.039 in</b>	0.015 to 1 mm <b>0.001 to 0.039 in</b>																																																		
			Copper			<b>GD-C1/C2</b>	0.03 to 6 mm	<b>0.001 to 0.236 in</b>	0.03 to 2 mm <b>0.001 to 0.079 in</b>																																																		
						<b>GD-C3</b>	0.018 to 1 mm	<b>0.001 to 0.039 in</b>	0.018 to 1 mm <b>0.001 to 0.039 in</b>																																																		
Brass	<b>GD-C1/C2</b>	0.03 to 6 mm	<b>0.001 to 0.236 in</b>	0.03 to 2 mm <b>0.001 to 0.079 in</b>																																																							
	<b>GD-C3</b>	0.01 to 1 mm	<b>0.0004 to 0.039 in</b>	0.01 to 1 mm <b>0.0004 to 0.039 in</b>																																																							
Stainless steel (SUS304)	<b>GD-C1/C2</b>	0.1 to 6 mm	<b>0.004 to 0.236 in</b>	0.1 to 2 mm <b>0.004 to 0.079 in</b>																																																							
	<b>GD-C3</b>	0.05 to 2 mm	<b>0.002 to 0.079 in</b>	0.05 to 1 mm <b>0.002 to 0.039 in</b>																																																							
Long sensing range		70 mm <b>2.756 in</b>	Standard sensing object size: 200 × 200 mm <b>7.874 × 7.874 in</b>	<b>GD-20</b>	<b>GD-C1 GD-C2</b>																																																						
			<table border="1"> <thead> <tr> <th>Material</th> <th>Setting distance</th> <th>35 mm <b>1.378 in</b></th> <th>70 mm <b>2.756 in</b></th> </tr> </thead> <tbody> <tr> <td>Iron (SPCC)</td> <td>0.07 to 10 mm</td> <td><b>0.003 to 0.394 in</b></td> <td>0.07 to 6 mm <b>0.003 to 0.236 in</b></td> </tr> <tr> <td>Aluminum</td> <td>0.03 to 10 mm</td> <td><b>0.001 to 0.394 in</b></td> <td>0.03 to 6 mm <b>0.001 to 0.236 in</b></td> </tr> <tr> <td>Copper</td> <td>0.03 to 10 mm</td> <td><b>0.001 to 0.394 in</b></td> <td>0.03 to 6 mm <b>0.001 to 0.236 in</b></td> </tr> <tr> <td>Brass</td> <td>0.03 to 10 mm</td> <td><b>0.001 to 0.394 in</b></td> <td>0.03 to 6 mm <b>0.001 to 0.236 in</b></td> </tr> <tr> <td>Stainless steel (SUS304)</td> <td>0.1 to 10 mm</td> <td><b>0.004 to 0.394 in</b></td> <td>0.1 to 6 mm <b>0.004 to 0.236 in</b></td> </tr> </tbody> </table>			Material	Setting distance	35 mm <b>1.378 in</b>	70 mm <b>2.756 in</b>	Iron (SPCC)	0.07 to 10 mm	<b>0.003 to 0.394 in</b>	0.07 to 6 mm <b>0.003 to 0.236 in</b>	Aluminum	0.03 to 10 mm	<b>0.001 to 0.394 in</b>	0.03 to 6 mm <b>0.001 to 0.236 in</b>	Copper	0.03 to 10 mm	<b>0.001 to 0.394 in</b>	0.03 to 6 mm <b>0.001 to 0.236 in</b>	Brass	0.03 to 10 mm	<b>0.001 to 0.394 in</b>	0.03 to 6 mm <b>0.001 to 0.236 in</b>	Stainless steel (SUS304)	0.1 to 10 mm	<b>0.004 to 0.394 in</b>	0.1 to 6 mm <b>0.004 to 0.236 in</b>																														
Material	Setting distance	35 mm <b>1.378 in</b>	70 mm <b>2.756 in</b>																																																								
Iron (SPCC)	0.07 to 10 mm	<b>0.003 to 0.394 in</b>	0.07 to 6 mm <b>0.003 to 0.236 in</b>																																																								
Aluminum	0.03 to 10 mm	<b>0.001 to 0.394 in</b>	0.03 to 6 mm <b>0.001 to 0.236 in</b>																																																								
Copper	0.03 to 10 mm	<b>0.001 to 0.394 in</b>	0.03 to 6 mm <b>0.001 to 0.236 in</b>																																																								
Brass	0.03 to 10 mm	<b>0.001 to 0.394 in</b>	0.03 to 6 mm <b>0.001 to 0.236 in</b>																																																								
Stainless steel (SUS304)	0.1 to 10 mm	<b>0.004 to 0.394 in</b>	0.1 to 6 mm <b>0.004 to 0.236 in</b>																																																								

Note: Only the combinations between the sensor heads and the controllers described in the above table are allowed. Any other combination may damage the connected sensor heads.

**10 m 32.808 ft cable length type and 20 m 65.617 ft cable length type**

10 m **32.808 ft** cable length type and 20 m **65.617 ft** cable length type for **GD-20** are also available. (Standard: 3 m **9.843 ft**)

Type	Standard	10 m <b>32.808 ft</b> cable length type	20 m <b>65.617 ft</b> cable length type
Long sensing range	<b>GD-20</b>	<b>GD-20-C10</b>	<b>GD-20-C20</b>

**Controllers**

Type	Appearance	Model No.	Output
Standard		<b>GD-C1</b>	NPN open-collector transistor
With RS-232C		<b>GD-C2</b>	
Small object detection		<b>GD-C3</b>	

Make sure to use the sensor heads and the controller together in the above combinations.

- FIBER SENSORS
- LASER SENSORS
- PHOTO-ELECTRIC SENSORS
- MICRO PHOTO-ELECTRIC SENSORS
- AREA SENSORS
- LIGHT CURTAINS / SAFETY COMPONENTS
- PRESSURE / FLOW SENSORS
- INDUCTIVE PROXIMITY SENSORS
- PARTICULAR USE SENSORS
- SENSOR OPTIONS
- SIMPLE WIRE-SAVING UNITS
- WIRE-SAVING SYSTEMS
- MEASURE-HEAT SENSORS
- STATIC ELECTRICITY PREVENTION DEVICES
- LASER MARKERS
- PLC
- HUMAN MACHINE INTERFACES
- ENERGY CONSUMPTION VISUALIZATION COMPONENTS
- FA COMPONENTS
- MACHINE VISION SYSTEMS
- UV CURING SYSTEMS

**SPECIFICATIONS****Sensor heads**

Item	Type	Small object detection		High precision		Long sensing range	
	Model No.	<b>GD-3</b>		<b>GD-10</b>		<b>GD-20</b>	
Applicable controllers		<b>GD-C3</b>		<b>GD-C1, GD-C2, GD-C3</b>		<b>GD-C1, GD-C2</b>	
Sensing range (between sensor heads)		10 mm <b>0.394 in</b> or less		30 mm <b>1.181 in</b> or less		70 mm <b>2.756 in</b> or less	
Detectable sheet thickness (Note 2)		Standard sensing object size: 20 × 20 mm <b>0.787 × 0.787 in</b>		Standard sensing object size: 80 × 80 mm <b>3.150 × 3.150 in</b>		Standard sensing object size: 200 × 200 mm <b>7.874 × 7.874 in</b>	
Material	Setting distance	5 mm <b>0.197 in</b>	10 mm <b>0.394 in</b>	20 mm <b>0.787 in</b>	30 mm <b>1.181 in</b>	35 mm <b>1.378 in</b>	70 mm <b>2.756 in</b>
	Applicable controllers	<b>GD-C1/C2</b>		<b>GD-C1/C2</b>		<b>GD-C1/C2</b>	
Iron (SPCC)	<b>GD-C1/C2</b>	0.01 to 0.1 mm <b>0.0004 to 0.004 in</b>	0.03 to 0.1 mm <b>0.001 to 0.004 in</b>	0.01 to 0.3 mm <b>0.0004 to 0.012 in</b>	0.07 to 0.5 mm <b>0.003 to 0.020 in</b>	0.07 to 10 mm <b>0.003 to 0.394 in</b>	0.07 to 6 mm <b>0.003 to 0.236 in</b>
	<b>GD-C3</b>	0.01 to 0.1 mm <b>0.0004 to 0.004 in</b>	0.03 to 0.1 mm <b>0.001 to 0.004 in</b>	0.01 to 0.3 mm <b>0.0004 to 0.012 in</b>	0.07 to 0.5 mm <b>0.003 to 0.020 in</b>	0.07 to 10 mm <b>0.003 to 0.394 in</b>	0.07 to 6 mm <b>0.003 to 0.236 in</b>
Aluminum	<b>GD-C1/C2</b>	0.015 to 1 mm <b>0.001 to 0.039 in</b>	0.015 to 1 mm <b>0.001 to 0.039 in</b>	0.03 to 6 mm <b>0.001 to 0.236 in</b>	0.03 to 2 mm <b>0.001 to 0.079 in</b>	0.03 to 10 mm <b>0.001 to 0.394 in</b>	0.03 to 6 mm <b>0.001 to 0.236 in</b>
	<b>GD-C3</b>	0.015 to 1 mm <b>0.001 to 0.039 in</b>	0.015 to 1 mm <b>0.001 to 0.039 in</b>	0.03 to 6 mm <b>0.001 to 0.236 in</b>	0.03 to 2 mm <b>0.001 to 0.079 in</b>	0.03 to 10 mm <b>0.001 to 0.394 in</b>	0.03 to 6 mm <b>0.001 to 0.236 in</b>
Copper	<b>GD-C1/C2</b>	0.018 to 1 mm <b>0.001 to 0.039 in</b>	0.018 to 0.3 mm <b>0.001 to 0.012 in</b>	0.018 to 1 mm <b>0.001 to 0.039 in</b>	0.018 to 1 mm <b>0.001 to 0.039 in</b>	0.03 to 10 mm <b>0.001 to 0.394 in</b>	0.03 to 6 mm <b>0.001 to 0.236 in</b>
	<b>GD-C3</b>	0.018 to 1 mm <b>0.001 to 0.039 in</b>	0.018 to 0.3 mm <b>0.001 to 0.012 in</b>	0.018 to 1 mm <b>0.001 to 0.039 in</b>	0.018 to 1 mm <b>0.001 to 0.039 in</b>	0.03 to 10 mm <b>0.001 to 0.394 in</b>	0.03 to 6 mm <b>0.001 to 0.236 in</b>
Brass	<b>GD-C1/C2</b>	0.03 to 1 mm <b>0.001 to 0.039 in</b>	0.03 to 0.5 mm <b>0.001 to 0.020 in</b>	0.03 to 6 mm <b>0.001 to 0.236 in</b>	0.03 to 2 mm <b>0.001 to 0.079 in</b>	0.03 to 10 mm <b>0.001 to 0.394 in</b>	0.03 to 6 mm <b>0.001 to 0.236 in</b>
	<b>GD-C3</b>	0.03 to 1 mm <b>0.001 to 0.039 in</b>	0.03 to 0.5 mm <b>0.001 to 0.020 in</b>	0.03 to 6 mm <b>0.001 to 0.236 in</b>	0.03 to 2 mm <b>0.001 to 0.079 in</b>	0.03 to 10 mm <b>0.001 to 0.394 in</b>	0.03 to 6 mm <b>0.001 to 0.236 in</b>
Stainless steel (SUS304)	<b>GD-C1/C2</b>	0.3 to 1 mm <b>0.012 to 0.039 in</b>	0.3 to 1 mm <b>0.012 to 0.039 in</b>	0.1 to 6 mm <b>0.004 to 0.236 in</b>	0.1 to 2 mm <b>0.004 to 0.079 in</b>	0.1 to 10 mm <b>0.004 to 0.394 in</b>	0.1 to 6 mm <b>0.004 to 0.236 in</b>
	<b>GD-C3</b>	0.3 to 1 mm <b>0.012 to 0.039 in</b>	0.3 to 1 mm <b>0.012 to 0.039 in</b>	0.1 to 6 mm <b>0.004 to 0.236 in</b>	0.1 to 2 mm <b>0.004 to 0.079 in</b>	0.1 to 10 mm <b>0.004 to 0.394 in</b>	0.1 to 6 mm <b>0.004 to 0.236 in</b>
Environmental resistance	Protection	IP67 (IEC)		IP67 (IEC), IP67G			
	Ambient temperature	-10 to +60 °C <b>+14 to +140 °F</b> , Storage: -25 to +70 °C <b>-13 to +158 °F</b>					
	Ambient humidity	45 to 85 % RH, Storage: 35 to 95 % RH					
	Vibration resistance	10 to 55 Hz frequency, 1.5 mm <b>0.059 in</b> amplitude in X, Y and Z directions for two hours each					
Shock resistance	1,000 m/s <sup>2</sup> acceleration (100 G approx.) in X, Y and Z directions for three times each						
Material		Enclosure: Stainless steel (SUS 303), Sensing face: ABS		Enclosure: Polyallylate		Sensing face: Polyacetal, Main body: Stainless steel	
Cable		Sender: 0.3 mm <sup>2</sup> single core shielded cable, 3 m <b>9.843 ft</b> long Receiver: 0.1 mm <sup>2</sup> 2-core shielded cable, 3 m <b>9.843 ft</b> long				Sender: 0.5 mm <sup>2</sup> single core shielded cable, 3 m <b>9.843 ft</b> long Receiver: 0.3 mm <sup>2</sup> 2-core shielded cable, 3 m <b>9.843 ft</b> long	
Cable extension		Extension up to total 20 m <b>65.617 ft</b> is possible with an equivalent shielded cable.					
Weight		Net weight: 90 g approx.		Net weight: 80 g approx.		Net weight: 440 g approx.	
Accessory		Sensor head mounting bracket: 1 set for sender and receiver					

Notes: 1) Where measurement conditions have not been specified precisely, the conditions used were an ambient temperature of +20 °C **+68 °F**.

2) The above detectable sheet thicknesses are typical data at the given sensing distance. The allowable thickness will differ from the range described in the above table at other setting distances. Further, double feeds of aluminum foils can also be detected at distances shorter than the above. Please contact our office for details.

**Controllers**

Item	Type	Standard	With RS-232C communication function	Small object detection
	Model No.	<b>GD-C1</b>	<b>GD-C2</b>	<b>GD-C3</b>
Supply voltage		12 to 24 V DC ±10 % Ripple P-P 10 % or less		
Current consumption		12 V DC: 700 mA or less, 24 V DC: 400 mA or less		
Output (OUT-1, OUT-2, ALM.) (Answer-back)		NPN open-collector transistor		
		<ul style="list-style-type: none"> <li>Maximum sink current: 100 mA</li> <li>Applied voltage: 30 V DC or less (between output and 0 V)</li> <li>Residual voltage: 1 V or less (at 100 mA sink current)</li> <li>0.4 V or less (at 16 mA sink current)</li> </ul>		
	Output Operation	OUT-1	OFF above the one-sheet threshold level	
		OUT-2	OFF above the two-sheet threshold level	
		ALM.	OFF when an error occurs	
Answer-back (ANS. OUT)	Refer to the time chart of the <b>"Sensitivity setting of PRECAUTIONS FOR PROPER USE"</b>			
Short-circuit protection		Incorporated		
Response time		Automatically selected either 5 ms or less, or 30 ms or less, depending on the object		5 ms or less
Set level storage function		Set values of eight channels stored		
Set level teaching function		Incorporated		
External setting function		Incorporated		
Indicators	Power	Green LED (lights up when the power is ON)		
	Self-diagnosis (ALM.)	Red LED (lights up during SET mode and when an error occurs during RUN mode)		
	Sensing mode (SENSE)	2-color indicator (lights up green during normal sensing mode, but yellow during precise sensing mode)		
	OUT-1	Green LED (lights up when OUT-1 is OFF, and blinks twice on completion of 0-ADJ. or SET-1 setting in SET mode)		
	OUT-2	Red LED (lights up when OUT-2 is OFF, and blinks twice on completion of 0-ADJ. or SET-2 setting in SET mode)		
Sensing level		Yellow LED × 1 and green LED × 6 (indicate the sensing level)		
Timer function		Approx. 50 ms fixed delay timer (switchable either effective or ineffective)		
Environmental resistance	Ambient temperature	-10 to +50 °C <b>+14 to +122 °F</b> (No dew condensation or icing allowed), Storage: -25 to +70 °C <b>-13 to +158 °F</b>		
	Ambient humidity	45 to 85 % RH, Storage: 35 to 90 % RH		
	Voltage withstandability	1,000 V AC for one min. between all supply terminals connected together and enclosure		
	Insulation resistance	50 MΩ, or more, with 250 V DC megger between all supply terminals connected together and enclosure		
	Vibration resistance	10 to 55 Hz frequency, 0.75 mm amplitude in X, Y and Z directions for two hours each		
Shock resistance		300 m/s <sup>2</sup> acceleration (30 G approx.) in X, Y and Z directions for three times each		
Material		Heat-resistant ABS		
Weight		Net weight: 440 g approx.		
Accessory		Insulation plate: 2 pcs.		

Note: Where measurement conditions have not been specified precisely, the conditions used were an ambient temperature of +20 °C **+68 °F**.

FIBER  
SENSORSLASER  
SENSORSPHOTO-  
ELECTRIC  
SENSORSMICRO  
PHOTO-  
ELECTRIC  
SENSORSAREA  
SENSORSLIGHT  
CURTAINS /  
SAFETY  
COMPONENTSPRESSURE /  
FLOW  
SENSORSINDUCTIVE  
PROXIMITY  
SENSORSPARTICULAR  
USE  
SENSORSSENSOR  
OPTIONSSIMPLE  
WIRE-SAVING  
UNITSWIRE-SAVING  
SYSTEMSMEASURE-  
MENT  
SENSORSSTATIC  
ELECTRICITY  
PREVENTION  
DEVICESLASER  
MARKERS

PLC

HUMAN  
MACHINE  
INTERFACESENERGY  
CONSUMPTION  
VISUALIZATION  
COMPONENTSFA  
COMPONENTSMACHINE  
VISION  
SYSTEMSUV  
CURING  
SYSTEMSSelection  
GuideLaser  
DisplacementMagnetic  
DisplacementCollimated  
BeamDigital Panel  
ControllerMetal-sheet  
Double-feed  
Detection**GD**

FIBER SENSORS  
LASER SENSORS  
PHOTO-ELECTRIC SENSORS  
MICRO PHOTO-ELECTRIC SENSORS  
AREA SENSORS  
LIGHT CURTAINS / SAFETY COMPONENTS  
PRESSURE / FLOW SENSORS  
INDUCTIVE PROXIMITY SENSORS  
PARTICULAR USE SENSORS  
SENSOR OPTIONS  
SIMPLE WIRE-SAVING UNITS  
WIRE-SAVING SYSTEMS  
MEASURE-MENT SENSORS  
STATIC ELECTRICITY PREVENTION DEVICES  
LASER MARKERS  
PLC  
HUMAN MACHINE INTERFACES  
ENERGY CONSUMPTION VISUALIZATION COMPONENTS  
FA COMPONENTS  
MACHINE VISION SYSTEMS  
UV CURING SYSTEMS

## I/O CIRCUIT AND WIRING DIAGRAMS

### Wiring diagram

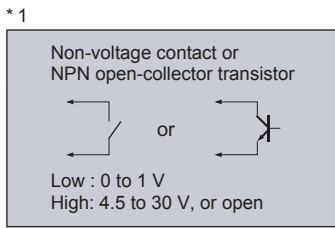
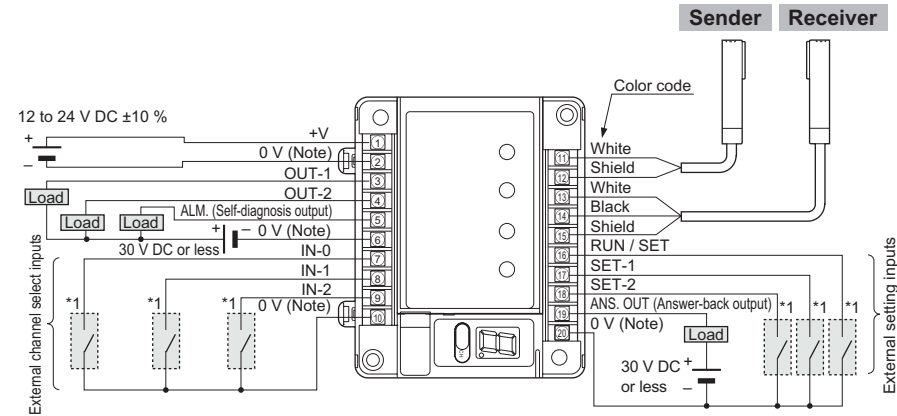

Note: Terminal ②, 0 V of power supply, is isolated from 0 V of input / output circuitry for noise immunity. However, if you expect to share the power supply with the output loads, connect terminals ② and ⑥, terminals ② and ⑩, or terminals ② and ⑳ to make 0 V common.

### I/O circuit diagram

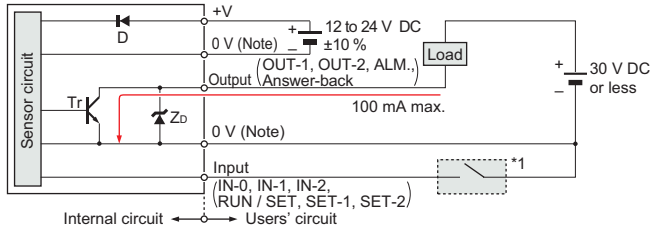

Note: 0 V of power supply is isolated from 0 V of input / output circuitry. To share the power supply with a load, both the 0 V terminals should be short-circuited.

Symbols ... D : Reverse supply polarity protection diode  
ZD: Surge absorption zener diode  
Tr : NPN output transistor

### External channel select truth table

Channel No. \ Input	IN-0	IN-1	IN-2
1	L	H	H
2	H	L	H
3	L	L	H
4	H	H	L
5	L	H	L
6	H	L	L
7	L	L	L
8	H	H	H

L: Low (0 to 1 V), H: High (4.5 to 30 V, or open)

### RS-232C wiring diagram (GD-C2 only)

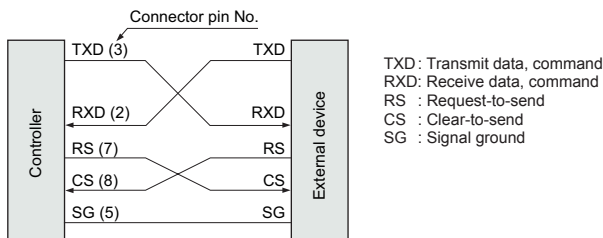

### Pin arrangement

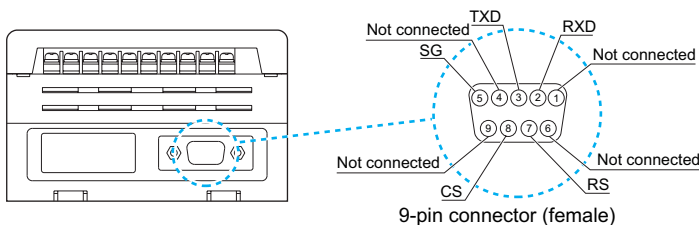

Selection Guide  
Laser Displacement  
Magnetic Displacement  
Collimated Beam  
Digital Panel Controller  
Metal-sheet Double-feed Detection

**PRECAUTIONS FOR PROPER USE**

Refer to p.1501 for general precautions.

FIBER  
SENSORSLASER  
SENSORSPHOTO-  
ELECTRIC  
SENSORSMICRO  
PHOTO-  
ELECTRIC  
SENSORSAREA  
SENSORSLIGHT  
CURTAINS /  
SAFETY  
COMPONENTSPRESSURE /  
FLOW  
SENSORSINDUCTIVE  
PROXIMITY  
SENSORSPARTICULAR  
USE  
SENSORSSENSOR  
OPTIONSSIMPLE  
WIRE-SAVING  
UNITSWIRE-SAVING  
SYSTEMSMEASURE-  
MENT  
SENSORSSTATIC  
ELECTRICITY  
PREVENTION  
DEVICESLASER  
MARKERS

PLC

HUMAN  
MACHINE  
INTERFACESENERGY  
CONSUMPTION  
VISUALIZATION  
COMPONENTSFA  
COMPONENTSMACHINE  
VISION  
SYSTEMSUV  
CURING  
SYSTEMSSelection  
GuideLaser  
DisplacementMagnetic  
DisplacementCollimated  
BeamDigital Panel  
ControllerMetal-sheet  
Double-feed  
Detection**GD**

- Never use this product as a sensing device for personnel protection.
- In case of using sensing devices for personnel protection, use products which meet laws and standards, such as OSHA, ANSI or IEC etc., for personnel protection applicable in each region or country.
- Make sure to use the sensor heads and controllers in the specified combinations. If they are used in any other combination, the sensor heads may get damaged.

**Mounting****Placing of sensor heads**

- Make the sender and receiver face each other and align their sensing center line.

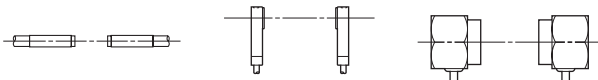

- Keep a distance from any magnet or a device generating magnetic field. It may degrade the detectability.
- Surrounding metal influences the detectability. Please contact our office for more details.
- If more than one set of sensor heads are closely mounted, detectability may be affected. Please contact our office for more details.

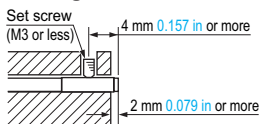
**Mounting sensor heads****<GD-3>****Mounting with set screw**

- Use a set screw (M3 or less), and the tightening torque should be 0.12 N·m or less.

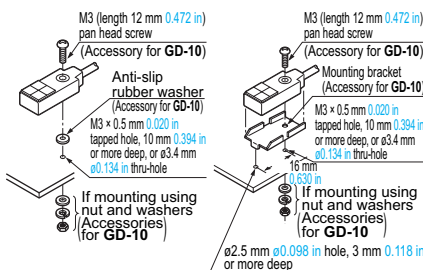
**<GD-10>****Fixing at one point    Fixing at two points**

- The tightening torque should be 0.5 N·m or less.
- To mount the sensor head with a nut, the thru-hole should be 3.4 mm  $\varnothing$ 0.134 in.  
(The mounting board must be 2.3 mm) 0.091 in, or less, thick.

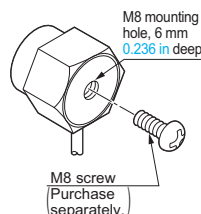
**<GD-20>**

- The tightening torque should be 11.2 N·m or less.

**Mounting of controller****<On DIN rail>**

- ① With the stopper pressed in the direction of the arrow (it locks), fit the front portion of the mounting section of the amplifier on the 35 mm 1.378 in width DIN rail.
- ② Press and fit the rear portion of the mounting section on the 35 mm 1.378 in width DIN rail.

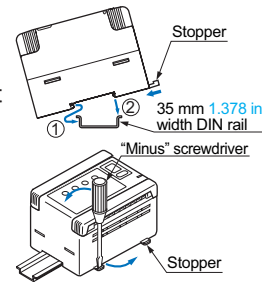

- \* To remove, insert a "minus" screwdriver into the stopper and pull out.

**<On board with screws>**

- Use two M4 pan head screws 10 mm 0.394 in, or more, long. The tightening torque should be 1.2 N·m or less.

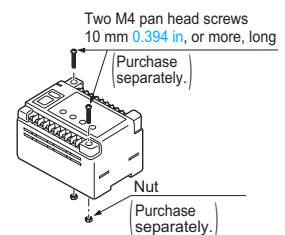
**Sensing mode**

- The **GD** series has two sensing modes, one is the normal sensing mode and the other is the precise sensing mode. They are automatically selected by the characteristics of the object.

**Normal sensing mode:** The **GD** series goes into this mode when the number of objects (e.g., large metal sheets) is distinguished with relative ease.



Iron etc.

**Precise sensing mode:** The **GD** series goes into this mode when the number of objects (e.g., lead frames) is difficult to distinguish. In this mode, the sensitivity difference is so minute between two sensing levels that vibration and temperature changes must be carefully managed.



Lead frame etc.

- The sensing mode indicator lights up green during the normal sensing mode, but lights up yellow during the precise sensing mode.



FIBER SENSORS  
LASER SENSORS  
PHOTO-ELECTRIC SENSORS  
MICRO PHOTO-ELECTRIC SENSORS  
AREA SENSORS  
LIGHT CURTAINS / SAFETY COMPONENTS  
PRESSURE / FLOW SENSORS  
INDUCTIVE PROXIMITY SENSORS  
PARTICULAR USE SENSORS  
SENSOR OPTIONS  
SIMPLE WIRE-SAVING UNITS  
WIRE-SAVING SYSTEMS  
MEASURE-NEXT SENSORS  
STATIC ELECTRICITY PREVENTION DEVICES  
LASER MARKERS  
PLC  
HUMAN MACHINE INTERFACES  
ENERGY CONSUMPTION VISUALIZATION COMPONENTS  
FA COMPONENTS  
MACHINE VISION SYSTEMS  
UV CURING SYSTEMS

**PRECAUTIONS FOR PROPER USE**

Refer to p.1501 for general precautions.

**Sensitivity setting**

**Teaching by external input**

- The teaching can also be performed by external input signals.

**Time chart**

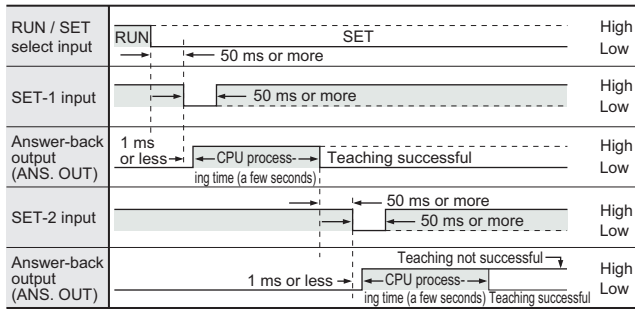

**Distance from nearby metals**

- As metals near the sensor head may affect the sensing performance, pay attention to the following points.

**Influence of nearby metal**

- The sensor head must be separated from nearby metal by a minimum distance as specified in the table below.

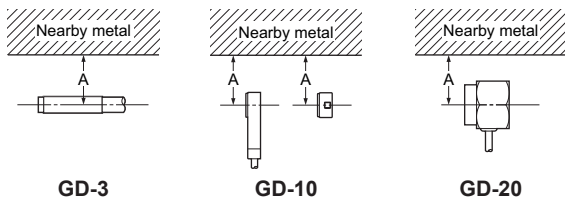

**Dimension A (in case of iron)**

Setting distance	5 mm	10 mm	30 mm	70 mm
Model No.	0.197 in	0.394 in	1.181 in	2.756 in
<b>GD-3</b>	15 mm 0.591 in	20 mm 0.787 in	—	—
<b>GD-10</b>	100 mm 3.937 in		—	—
<b>GD-20</b>	100 mm 3.937 in			

**Embedding in metal**

- The sensing performance may be affected if the sensor is completely embedded in a metal. Keep a minimum clearance between the sensor head and the metal as specified in the table below.

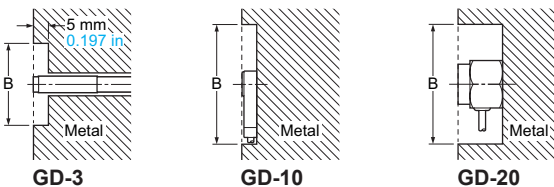

**Dimension B (in case of iron)**

Setting distance	5 mm	10 mm	30 mm	70 mm
Model No.	0.197 in	0.394 in	1.181 in	2.756 in
<b>GD-3</b>	ø15 mm ø0.591 in	ø20 mm ø0.787 in	—	—
<b>GD-10</b>	ø100 mm ø3.937 in		—	—
<b>GD-20</b>	ø300 mm ø11.811 in			

**Interference prevention**

- When two or more sensor heads are mounted in parallel, keep a minimum separation distance as specified below to avoid interference.

**In case the sender and another sensor's receiver are placed adjacently**

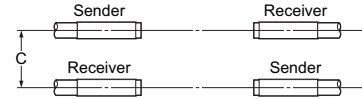

**Dimension C**

Setting distance (Note)	5 mm	10 mm	20 (35) mm	30 (70) mm
Model No.	0.197 in	0.394 in	0.787 (1.378) in	1.181 (2.756) in
<b>GD-3</b>	60 mm 2.362 in	80 mm 3.150 in	—	—
<b>GD-10</b>	160 mm 6.299 in		—	220 mm 8.661 in
<b>GD-20</b>	370 mm 14.567 in		—	630 mm 24.803 in

Note: The value in the brackets is for GD-20.

**In case the respective senders and receivers are placed adjacently**

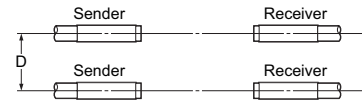

**Dimension D**

Setting distance (Note)	5 mm	10 mm	20 (35) mm	30 (70) mm
Model No.	0.197 in	0.394 in	0.787 (1.378) in	1.181 (2.756) in
<b>GD-3</b>	30 mm 1.181 in	50 mm 1.969 in	—	—
<b>GD-10</b>	200 mm 7.874 in		—	250 mm 9.843 in
<b>GD-20</b>	450 mm 17.717 in		—	700 mm 27.559 in

Note: The value in the brackets is for GD-20.

**RS-232C DATA TRANSMISSION (GD-C2 only)**

- GD-C2 can feed in the set level data into a PC or PLC memory using RS-232C serial communication and retrieve it whenever required. In this case, the taught data should be stored in the prescribed channel.

**Transmission specifications**

- Baud rate: Selectable from 300, 600, 1,200, 2,400, 4,800, 9,600, 19,200, or 31,250 bits/sec.
- Format: Data bits ... 7 bits or 8 bits  
Parity check ..... None or Enable, Even or Odd  
Stop bits ..... 1 bit or 2 bits  
Terminal code ..... CR or ETX

**Self-diagnosis (Alarm) function**

- The GD series constantly runs self-diagnosis, outputs the result with self-diagnosis output, and lights the self-diagnosis indicator. In addition, error content is shown on the channel display using error codes.

**Others**

- Do not operate the sensor for a few seconds immediately after supplying power because of transient conditions including self-diagnosis time.

- Make sure to check the ability of the sensor to detect the number of sheets of your actual objects before use. If real objects differ from teaching samples in size or in characteristics, or the detecting condition deviates, an error may occur. Please note that magnetic metals or metals with low magnetic permeability such as steel especially have a strong tendency.
- In situations when magnets are in close proximity such as during electromagnet conveyance, this causes malfunctions due to electromagnetic disorder.
- When conducting minute detections, favorable sensing conditions are obtained only after having elapsed 60 min. after the initial introduction of the power supply.



**DIMENSIONS (Unit: mm in)**

The CAD data in the dimensions can be downloaded from our website.

**GD-3 Sensor head**

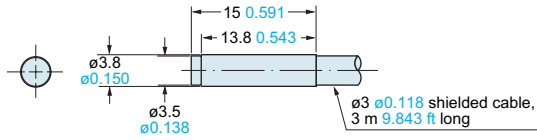

**GD-10 Sensor head**

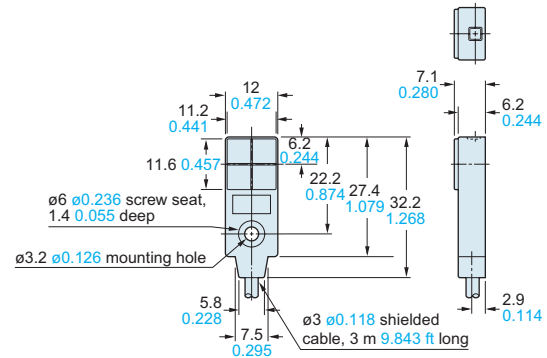

**GD-20 Sensor head**

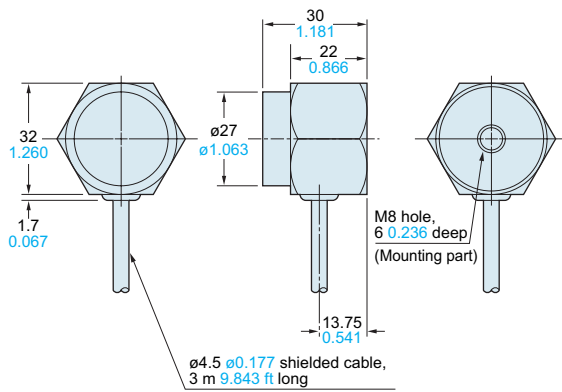

**GD-C1 GD-C2 GD-C3 Controller**

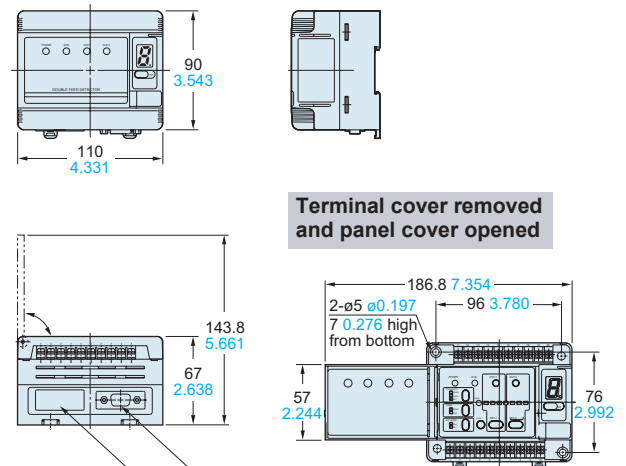

**Sensor head mounting bracket set (Accessory for GD-10)**

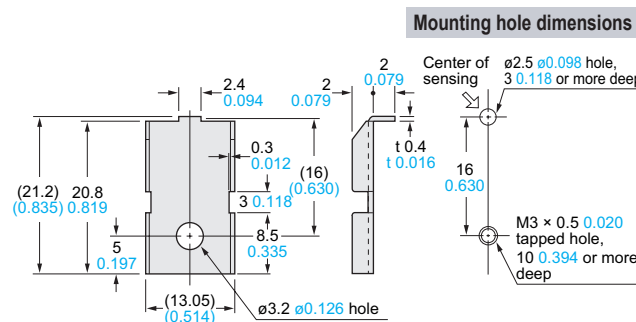

Material: Cold rolled carbon steel (SPCC) (Nickel plated)  
 1 pc. each of M3 (length 12 mm 0.472 in) pan head screw, nut, plain washer, spring washer, and anti-slip rubber washer (ø9.5 × t 0.5 mm ø0.374 × t 0.020 in) is attached.

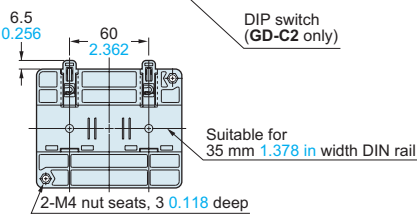

**Panel cut-out dimensions**

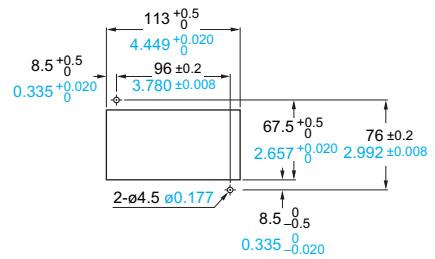

FIBER SENSORS
LASER SENSORS
PHOTO-ELECTRIC SENSORS
MICRO PHOTO-ELECTRIC SENSORS
AREA SENSORS
LIGHT CURTAINS / SAFETY COMPONENTS
PRESSURE / FLOW SENSORS
INDUCTIVE PROXIMITY SENSORS
PARTICULAR USE SENSORS
SENSOR OPTIONS
SIMPLE WIRE-SAVING UNITS
WIRE-SAVING SYSTEMS
MEASUREMENT SENSORS
STATIC ELECTRICITY PREVENTION DEVICES
LASER MARKERS
PLC
HUMAN MACHINE INTERFACES
ENERGY CONSUMPTION VISUALIZATION COMPONENTS
FA COMPONENTS
MACHINE VISION SYSTEMS
UV CURING SYSTEMS
Selection Guide
Laser Displacement
Magnetic Displacement
Collimated Beam
Digital Panel Controller
Metal-sheet Double-feed Detection

**GD**