



Chipsmall Limited consists of a professional team with an average of over 10 year of expertise in the distribution of electronic components. Based in Hongkong, we have already established firm and mutual-benefit business relationships with customers from,Europe,America and south Asia,supplying obsolete and hard-to-find components to meet their specific needs.

With the principle of “Quality Parts,Customers Priority,Honest Operation,and Considerate Service”,our business mainly focus on the distribution of electronic components. Line cards we deal with include Microchip,ALPS,ROHM,Xilinx,Pulse,ON,Everlight and Freescale. Main products comprise IC,Modules,Potentiometer,IC Socket,Relay,Connector.Our parts cover such applications as commercial,industrial, and automotives areas.

We are looking forward to setting up business relationship with you and hope to provide you with the best service and solution. Let us make a better world for our industry!



Contact us

Tel: +86-755-8981 8866 Fax: +86-755-8427 6832

Email & Skype: info@chipsmall.com Web: www.chipsmall.com

Address: A1208, Overseas Decoration Building, #122 Zhenhua RD., Futian, Shenzhen, China



GL514/GL513F

TO-18 Type Infrared Emitting Diode

■ Features

- Output : **GL514** Φ_e MIN. 3.31mW at
 $I_F = 100\text{mA}$
GL513F Φ_e MIN. 1.44mW at
 $I_F = 100\text{mA}$
- Beam angle : **GL514** $\Delta\theta$: TYP. $\pm 7^\circ$
GL513F $\Delta\theta$: TYP. $\pm 50^\circ$
- To- 18 type standard package
- High reliability, long operation life

■ Applications

- Optoelectronic switches
- Smoke detectors
- Infrared applied systems

■ Absolute Maximum Ratings ($T_a = 25^\circ\text{C}$)

Parameter	Symbol	Rating	Unit
Power dissipation	P	250	mW
Forward current	I_F	150	mA
^{*1} Peak forward current	I_{FM}	2	A
Reverse voltage	V_R	6	V
Operating temperature	T_{opr}	- 40 to + 125	$^\circ\text{C}$
Storage temperature	T_{stg}	- 55 to + 125	$^\circ\text{C}$
^{*2} Soldering temperature	T_{sol}	260	$^\circ\text{C}$

^{*1} Pulse width $\leq 200\ \mu\text{s}$

Duty ratio = 0.01

^{*2} For 10 seconds at the position of 1.3mm from the bottom face of can package.

■ Electro-optical Characteristics ($T_a = 25^\circ\text{C}$)

Parameter	Symbol	Conditions	MIN.	TYP.	MAX.	Unit
Forward voltage	V_F	$I_F = 100\text{mA}$	-	1.35	1.6	V
Peak forward voltage	V_{FM}	$I_{FM} = 1.5\text{A}$	-	2.75	4.0	V
Reverse current	I_R	$V_R = 5\text{V}$	-	-	100	μA
Terminal capacitance	C_t	$V = 0, f = 1\text{MHz}$	-	70	-	pF
^{*3} Radiant flux	GL514	$I_F = 100\text{mA}$	3.31	5.35	10.0	mW
	GL513F		1.44	2.88	-	mW
Peak emission wavelength	λ_p	$I_F = 100\text{mA}$	-	950	-	nm
Half intensity wavelength	$\Delta\lambda$	$I_F = 100\text{mA}$	-	45	-	nm

■ Outline Dimensions

(Unit : mm)

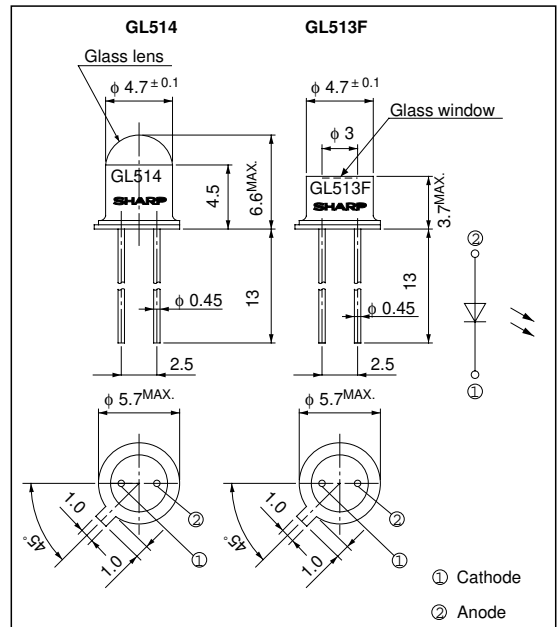

***3 Classification Table of Radiant Flux**

Model No.	Rank Mark	Φ_e (mW)
GL514A	A	5.35 to 10.0
GL514	-	3.31 to 10.0

at $I_F = 100\text{mA}$, $T_a = 25^\circ\text{C}$

Fig. 1 Forward Current vs. Ambient Temperature

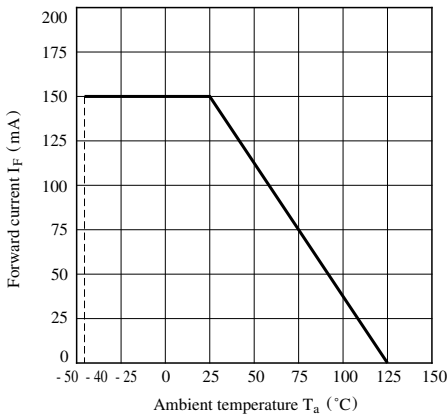

Fig. 2 Peak Forward Current vs. Duty Ratio

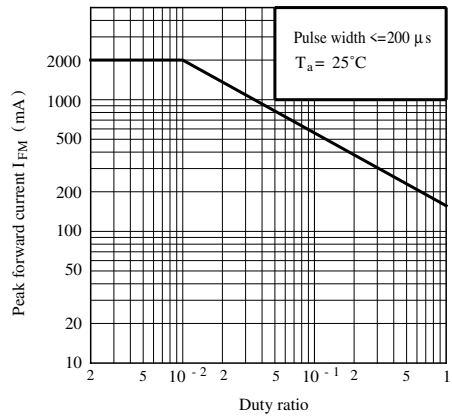

Fig. 3 Spectral Distribution

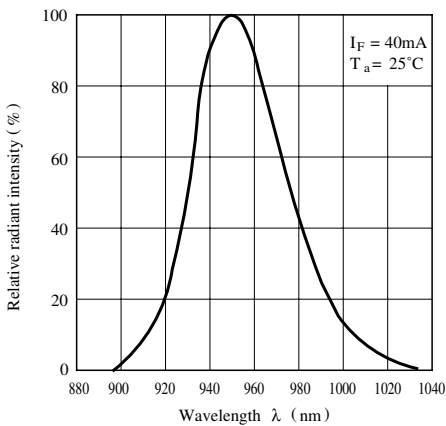

Fig. 4 Peak Emission Wavelength vs. Ambient Temperature

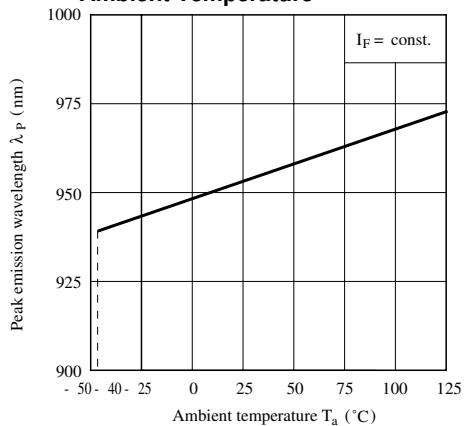

Fig. 5 Forward Current vs. Forward Voltage

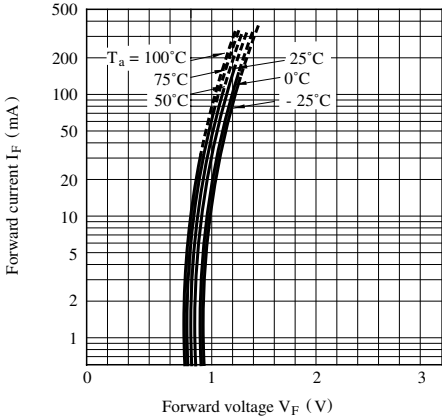

Fig. 6 Relative Radiant Flux vs. Ambient Temperature

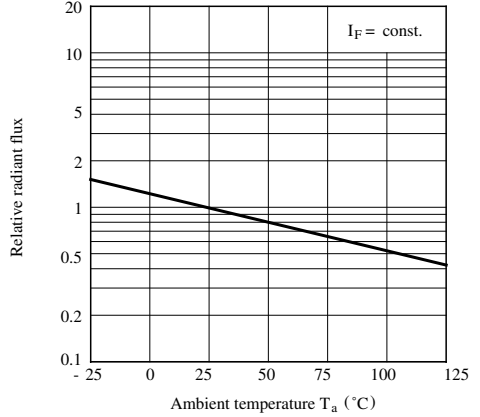

Fig. 7 Radiant Flux vs. Forward Current (GL514)

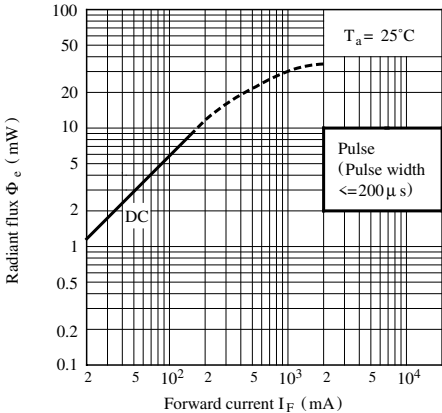

Fig. 8 Radiant Flux vs. Forward Current (GL513F)

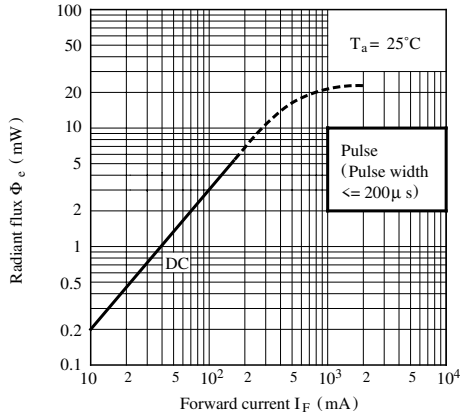

Fig. 9 Relative Radiant Intensity vs. Distance (GL514)

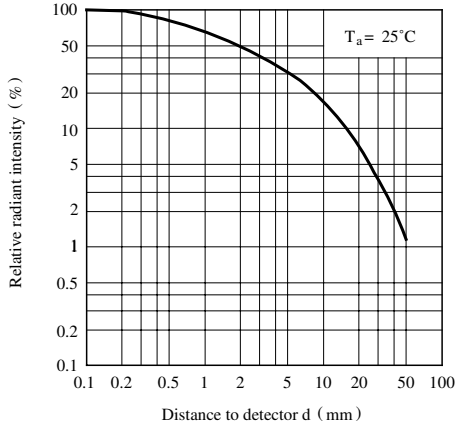

Fig. 10 Relative Radiant Intensity vs. Distance (GL513F)

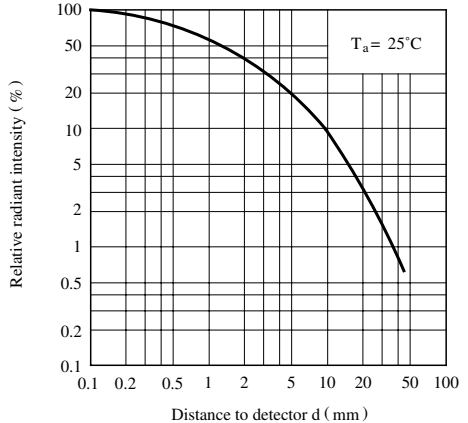
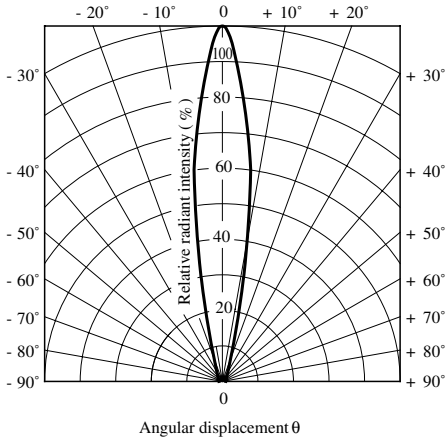
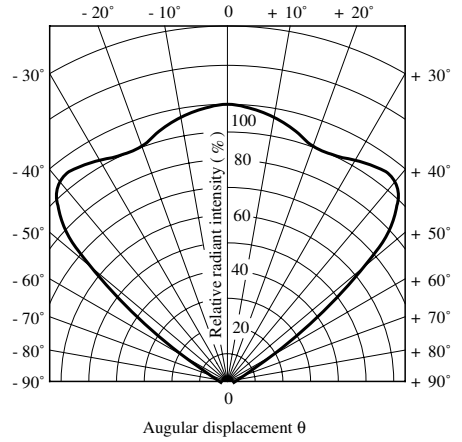

Fig.11 Radiation Diagram (GL514) $(T_a = 25^\circ\text{C})$ **Fig.12 Radiation Diagram (GL513F)** $(T_a = 25^\circ\text{C})$ 

● Please refer to the chapter “Precautions for Use.”

NOTICE

- The circuit application examples in this publication are provided to explain representative applications of SHARP devices and are not intended to guarantee any circuit design or license any intellectual property rights. SHARP takes no responsibility for any problems related to any intellectual property right of a third party resulting from the use of SHARP's devices.
- Contact SHARP in order to obtain the latest device specification sheets before using any SHARP device. SHARP reserves the right to make changes in the specifications, characteristics, data, materials, structure, and other contents described herein at any time without notice in order to improve design or reliability. Manufacturing locations are also subject to change without notice.
- Observe the following points when using any devices in this publication. SHARP takes no responsibility for damage caused by improper use of the devices which does not meet the conditions and absolute maximum ratings to be used specified in the relevant specification sheet nor meet the following conditions:
 - (i) The devices in this publication are designed for use in general electronic equipment designs such as:
 - Personal computers
 - Office automation equipment
 - Telecommunication equipment [terminal]
 - Test and measurement equipment
 - Industrial control
 - Audio visual equipment
 - Consumer electronics
 - (ii) Measures such as fail-safe function and redundant design should be taken to ensure reliability and safety when SHARP devices are used for or in connection with equipment that requires higher reliability such as:
 - Transportation control and safety equipment (i.e., aircraft, trains, automobiles, etc.)
 - Traffic signals
 - Gas leakage sensor breakers
 - Alarm equipment
 - Various safety devices, etc.
 - (iii) SHARP devices shall not be used for or in connection with equipment that requires an extremely high level of reliability and safety such as:
 - Space applications
 - Telecommunication equipment [trunk lines]
 - Nuclear power control equipment
 - Medical and other life support equipment (e.g., scuba).
- Contact a SHARP representative in advance when intending to use SHARP devices for any "specific" applications other than those recommended by SHARP or when it is unclear which category mentioned above controls the intended use.
- If the SHARP devices listed in this publication fall within the scope of strategic products described in the Foreign Exchange and Foreign Trade Control Law of Japan, it is necessary to obtain approval to export such SHARP devices.
- This publication is the proprietary product of SHARP and is copyrighted, with all rights reserved. Under the copyright laws, no part of this publication may be reproduced or transmitted in any form or by any means, electronic or mechanical, for any purpose, in whole or in part, without the express written permission of SHARP. Express written permission is also required before any use of this publication may be made by a third party.
- Contact and consult with a SHARP representative if there are any questions about the contents of this publication.