



Chipsmall Limited consists of a professional team with an average of over 10 year of expertise in the distribution of electronic components. Based in Hongkong, we have already established firm and mutual-benefit business relationships with customers from,Europe,America and south Asia,supplying obsolete and hard-to-find components to meet their specific needs.

With the principle of “Quality Parts,Customers Priority,Honest Operation,and Considerate Service”,our business mainly focus on the distribution of electronic components. Line cards we deal with include Microchip,ALPS,ROHM,Xilinx,Pulse,ON,Everlight and Freescale. Main products comprise IC,Modules,Potentiometer,IC Socket,Relay,Connector.Our parts cover such applications as commercial,industrial, and automotives areas.

We are looking forward to setting up business relationship with you and hope to provide you with the best service and solution. Let us make a better world for our industry!



Contact us

Tel: +86-755-8981 8866 Fax: +86-755-8427 6832

Email & Skype: info@chipsmall.com Web: www.chipsmall.com

Address: A1208, Overseas Decoration Building, #122 Zhenhua RD., Futian, Shenzhen, China



MICRO SWITCH Miniature Industrial Limit Switch

GLL Series

002310

Issue 4

Datasheet



DESCRIPTION

Honeywell provides a wide selection of industrial limit switches for machinery and equipment on indoor and outdoor applications. When the solution for the application is a small global limit switch, Honeywell offers the GLL Series miniature industrial limit switch. The GLL Series switches are designed with global certifications for worldwide use. With an integral contact block, the design also provides a double-insulated thermoplastic housing and conforms to the EN50047 mounting pattern with IP and NEMA environmental sealing. A wide variety of linear and rotary actuators is available as well as contact block options to satisfy many applications. All normally closed contacts are positive opening ➡.

VALUE TO CUSTOMERS

- Designed to EN50047 standards
- AC15, A600 and DC13, Q300 control circuit electrical ratings for world-wide acceptance
- Wide range of actuators and circuitry options in same package
- CCC, CE, CSA, and cULus certifications for global acceptance

FEATURES

- Ten different actuator heads, five different contact options, and two different conduits
- Designed to EN50047 standard
- Double insulated plastic housing
- Integral threaded conduit of 0.5 NPT or 20 mm
- Positive opening normally closed contacts to IEC 60947-5-1-3 ➡
- Certified for global applications; CE, cULus, CSA, CCC
- Galvanically isolated poles or throws [Zb] within contact block
- Double break snap action or slow action contacts
- Hinge cover with single fastener for easy wiring access
- IP66 environmental sealing for indoor or outdoor applications
- ROHS compliant

POTENTIAL INDUSTRIAL APPLICATIONS

- Aerial platforms/Lifts
- Elevators/Escalators
- Industrial Doors/Gates
- Packaging equipment

DIFFERENTIATION

- Double insulated thermoplastic limit switch with integral contact block
- Cost effective EN50047 type limit switch with world-wide availability

PORTFOLIO

The GLL Series global limit switches are a segment of the Honeywell industrial global limit switch offering. The global limit switch products also include the GLA Series, the miniature GLC, GLD, and GLE Series, the NGC Series, and SZL-VL Series. In addition to the global limit switch series, Honeywell provides a comprehensive line of medium duty industrial limit switches (CE Series, E6/V6 Series, LS Series) and heavy-duty limit switches (HDLS Series).

MICRO SWITCH Miniature Industrial Limit Switch, GLL Series

Table 1. Specifications

Characteristic	Parameter
Description	EN50047 industrial global limit switch
Certifications	CE, CCC, cULus, CSA
Conforming to standards	CE [EN60947-5-1]; CCC [GB 14048.5]; UL & cUL [UL508, File E37138]; CSA B44.1-04/ASME-A17.5-2004
Housing material	Thermoplastic reinforced with glass fiber
Actuators	Side rotary with fixed levers, side rotary with adjustable levers, side rotary with adjustable rod, top pin plunger, top roller plunger, top horizontal roller lever, top vertical roller lever
Conduit	0.5-14 NPT, 20 mm
Contact options*	1NC-1NO snap action, 1NC-1NO slow action break before make [BBM], 1NC-1NO slow action make before break [MBB], 2NC slow action. Poles or throws are electrically isolated [Zb]
Contact material	Silver alloy
Utilization category	AC-15, A600; DC-13, Q300
Rated operational voltage [Ue]	600 Vac, 250 Vdc
Rated operational current [Ie]	1.2 A, 0.27 A
Thermal current [Ith]	10 A
Rated insulation voltage [Ui]	600 V
Rated impulse withstand voltage (Uimp)	2500 V
Short Circuit Protective Device [SCPD] type & rating	Class J fuse, rated 10A, 600V
Sealing	IP66; NEMA 1, 12, 13
Operating temperature	-10 °C to 80 °C [14 °F to 176 °F]
Mechanical life	Up to 5 million operations
Vibration [w/o actuator]	10 g per IEC 60068-2-6
Shock [w/o actuator]	50 g per IEC 60068-2-27

* All normally closed (NC) contacts are positive opening .

Table 2. Electrical Specifications

ac		dc	
A600 Ue Volts	AC-15 Ie Amps	Q300 Ue Volts	DC-13 Ie Amps
120	6	125	0.55
240	3	250	0.27
380	1.9		
480	1.5		
500	1.4		
600	1.2		

MICRO SWITCH Miniature Industrial Limit Switch, GLL Series

Figure 1. Product Nomenclature

	GLL Switch Type	A Conduit	01 Contact Block	A Head Style	1B Lever Style
GLL Series Miniature Industrial Limit Switch	A 0.5-14 NPT	01 1NC/1NO snap action	A Side rotary (requires lever)	1B Fixed plastic (R 25 mm) Ø17 mm metal roller	
	C 20 mm	03 1NC/1NO slow action BBM	B Top pin plunger	1Y Fixed plastic (R 31,5 mm) Ø50 mm rubber roller	
		04 1NC/1NO slow action MBB	C Top roller plunger	2B Adjustable metal (R20 mm to 75 mm) Ø17 mm metal roller	
		06 2NC slow action	D Top horizontal roller plunger	2Y Adjustable metal (R31,5 mm to 75 mm) Ø50 mm rubber roller	
		07 1NC/1NO snap action (gold-plated contacts)	F Top vertical roller plunger	3B Fixed plastic (R 31,55 mm) Ø17 mm metal roller	
				4J Ø3mm adjustable metal rod (22 mm to 150 mm)	

MICRO SWITCH Miniature Industrial Limit Switch, GLL Series

MICRO SWITCH GLL SERIES ORDER GUIDE/RECOMMENDED LISTINGS

Table 3. Side Rotary 25 mm lever with Ø17 mm metal roller

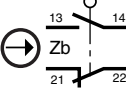
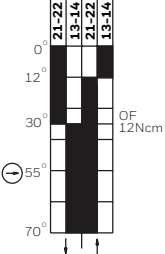
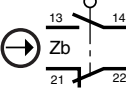
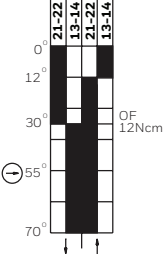
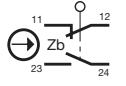
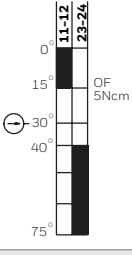
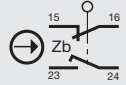
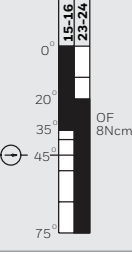
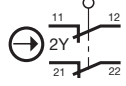
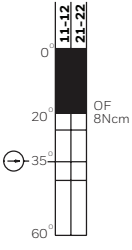
	Contacts	Contact Type	Contact Material	Operating Torque max. Ncm [in-lb]	Bar Chart ¹	0.5-14 NPT Conduit	20 mm Conduit
	1NC-1NO	Snap action 	silver	12 [1.06]		GLLA01A1B	GLLC01A1B
	1NC-1NO		gold-plated	12 [1.06]		GLLA07A1B	-
	1NC-1NO	BBM, slow action 	silver	5 [0.44]		GLLA03A1B	GLLC03A1B
	1NC-1NO	MBB, slow action 	silver	8 [0.71]		GLLA04A1B	GLLC04A1B
	2NC	Slow action 	silver	8 [0.71]		GLLA06A1B	GLLC06A1B

¹Contact closed ■; Contact open □. *Positive opening occurs.

MICRO SWITCH Miniature Industrial Limit Switch, GLL Series

Table 4. Side Rotary 31,5 mm Lever with Ø17 mm Metal Roller

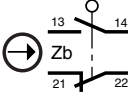
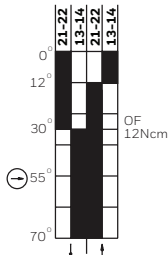
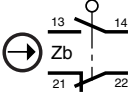
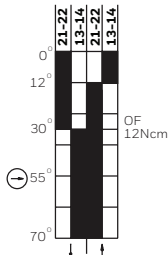
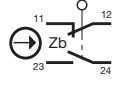
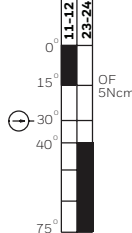
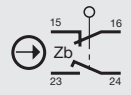
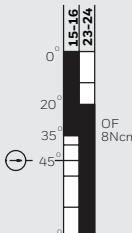
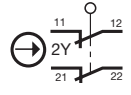
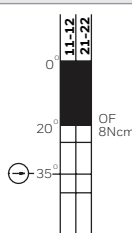
	Contacts	Contact Type	Contact Material	Operating Torque max. Ncm [in-lb]	Bar Chart ¹	0.5-14 NPT Conduit	20 mm Conduit
	1NC-1NO	Snap action 	silver	12 [1.06]		GLLA01A3B	-
	1NC-1NO		gold-plated	12 [1.06]		GLLA07A3B	-
	1NC-1NO	BBM, slow action 	silver	5 [0.44]		GLLA03A3B	GLLC03A3B
	1NC-1NO	MBB, slow action 	silver	8 [0.71]		GLLA04A3B	GLLC04A3B
	2NC	Slow action 	silver	8 [0.71]		GLLA06A3B	GLLC06A3B

¹Contact closed ■; Contact open □. *Positive opening occurs.

MICRO SWITCH Miniature Industrial Limit Switch, GLL Series

Table 5. Side Rotary, 20 mm to 75 mm Adjustable Lever with Ø17 mm Metal Roller

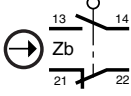
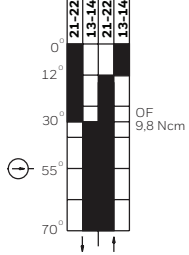
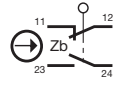
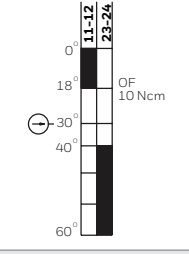
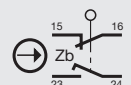
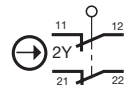
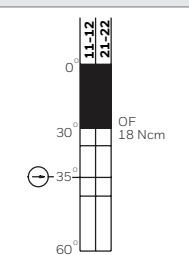
	Contacts	Contact Type	Contact Material	Operating Torque max. Ncm [in-lb]	Bar Chart ¹	0.5-14 NPT Conduit	20 mm Conduit
	1NC-1NO	Snap action 	silver	9.8 [0.87]		GLLA01A2B	GLLC01A2B
	1NC-1NO		gold-plated	9.8 [0.87]		GLLA07A2B	-
	1NC-1NO	BBM, slow action 	silver	10 [0.88]		GLLA03A2B	GLLC03A2B
	1NC-1NO	MBB, slow action 	silver	15.0 [1.33]		GLLA04A2B	GLLC04A2B
	2NC	Slow action 	silver	15.0 [1.33]		GLLA06A2B	GLLC06A2B

¹Contact closed ■; Contact open □. *Positive opening occurs.

MICRO SWITCH Miniature Industrial Limit Switch, GLL Series

Table 6. Side Rotary, 31,5 mm Lever with Ø50 mm Rubber Roller

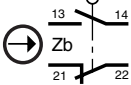
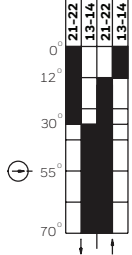
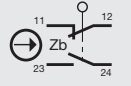
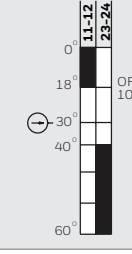
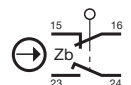
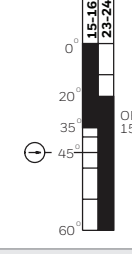
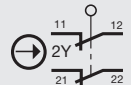
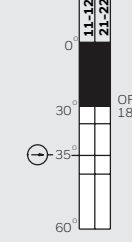
	Contacts	Contact Type	Contact Material	Operating Torque max. Ncm [in-lb]	Bar Chart ¹	0.5-14 NPT Conduit	20 mm Conduit
	1NC-1NO	Snap action 	silver	9,8 [0.87]		GLLA01A1Y	GLLC01A1Y
	1NC-1NO	BBM, slow action 	silver	10 [0.88]		GLLA03A1Y	GLLC03A1Y
	1NC-1NO	MBB, slow action 	silver	15 [1.33]		GLLA04A1Y	GLLC04A1Y
	2NC	Slow action 	silver	18 [1.59]		GLLA06A1Y	GLLC06A1Y

¹Contact closed ■; Contact open □. *Positive opening occurs.

MICRO SWITCH Miniature Industrial Limit Switch, GLL Series

Table 7. Side Rotary, 31,5 mm to 75 mm Adjustable Lever with Ø50 mm Rubber Roller

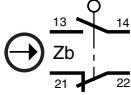
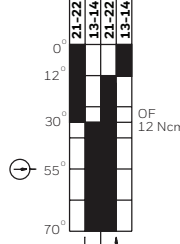
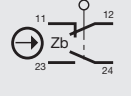
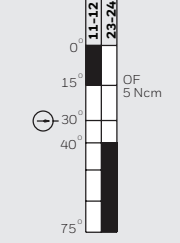
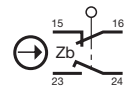
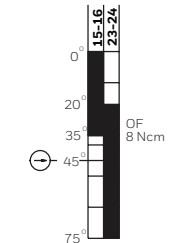
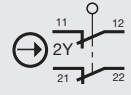
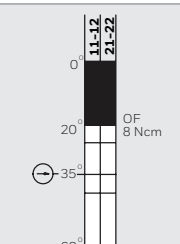
	Contacts	Contact Type	Contact Material	Operating Torque max. Ncm [in-lb]	Bar Chart ¹	0.5-14 NPT Conduit	20 mm Conduit
	1NC-1NO	Snap action 	silver	12 [1.06]		GLLA01A2Y	GLLC01A2Y
	1NC-1NO	BBM, slow action 	silver	5 [0.44]		GLLA03A2Y	GLLC03A2Y
	1NC-1NO	MBB, slow action 	silver	8 [0.71]		GLLA04A2Y	GLLC04A2Y
	2NC	Slow action 	silver	8 [0.71]		GLLA06A2Y	GLLC06A2Y

¹Contact closed ■; Contact open □. *Positive opening occurs.

MICRO SWITCH Miniature Industrial Limit Switch, GLL Series

Table 8. Side Rotary, 22 mm to 150 mm with Ø3 mm Adjustable Metal Rod

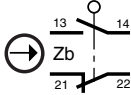
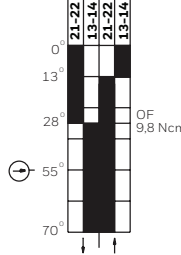
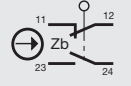
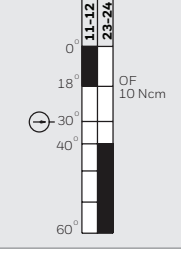
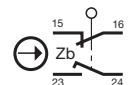
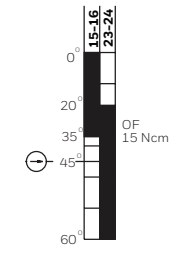
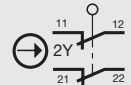
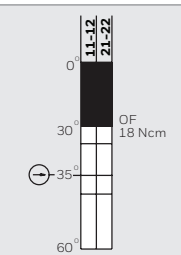
	Contacts	Contact Type	Contact Material	Operating Torque max. Ncm [in-lb]	Bar Chart ¹	0.5-14 NPT Conduit	20 mm Conduit
	1NC-1NO	Snap action 	silver	9,8 [0.87]		GLLA01A4J	GLLC01A4J
	1NC-1NO	BBM, slow action 	silver	10 [0.88]		GLLA03A4J	GLLC03A4J
	1NC-1NO	MBB, slow action 	silver	15 [1.33]		GLLA04A4J	GLLC04A4J
	2NC	Slow action 	silver	18 [1.59]		GLLA06A4J	GLLC06A4J

¹Contact closed ■, Contact open □. *Positive opening occurs.

MICRO SWITCH Miniature Industrial Limit Switch, GLL Series

Table 9. Top Pin Plunger

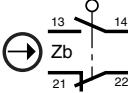
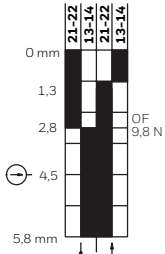
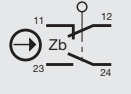
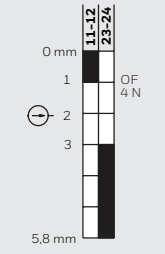
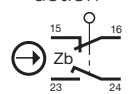
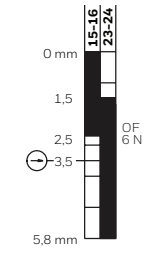
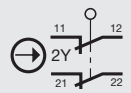
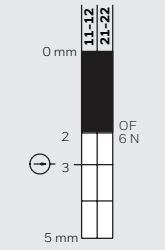
	Contacts	Contact Type	Contact Material	Operating Force max. N [lb]	Bar Chart ¹	0.5-14 NPT Conduit	20 mm Conduit
	1NC-1NO	Snap action 	silver	9,8 [2.22]		GLLA01B	GLLC01B
	1NC-1NO	BBM, slow action 	silver	4 [0.9]		GLLA03B	GLLC03B
	1NC-1NO	MBB, slow action 	silver	6 [1.35]		GLLA04B	GLLC04B
	2NC	Slow action 	silver	6 [1.35]		GLLA06B	GLLC06B

¹Contact closed ■; Contact open □. *Positive opening occurs.

MICRO SWITCH Miniature Industrial Limit Switch, GLL Series

Table 10. Top Roller Plunger

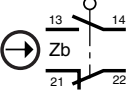
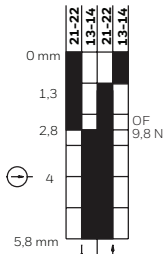
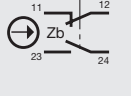
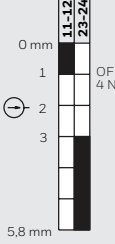
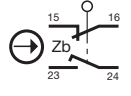
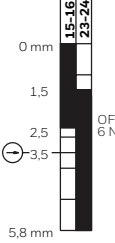
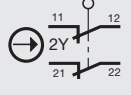
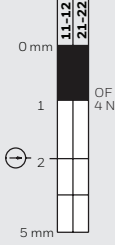
	Contacts	Contact Type	Contact Material	Operating Force max. N [lb]	Bar Chart ¹	0.5-14 NPT Conduit	20 mm Conduit
	1NC-1NO	Snap action 	silver	9,8 [2.22]		GLLA01C	GLLA01C
	1NC-1NO	BBM, slow action 	silver	4 [0.9]		GLLA03C	GLLA03C
	1NC-1NO	MBB, slow action 	silver	6 [1.35]		GLLA04C	GLLC04C
	2NC	Slow action 	silver	4 [0.9]		GLLA06C	GLLC06C

¹Contact closed ■; Contact open □. *Positive opening occurs.

MICRO SWITCH Miniature Industrial Limit Switch, GLL Series

Table 11. Top Horizontal Roller Lever

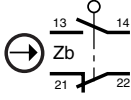
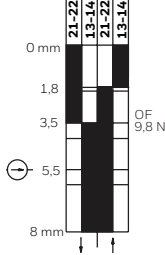
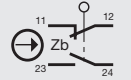
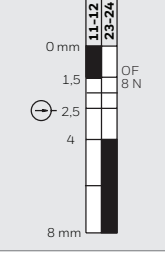
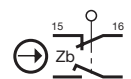
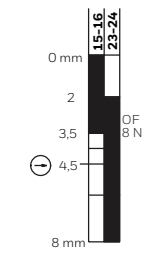
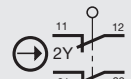
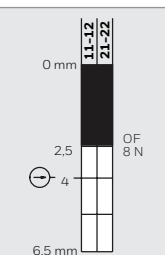
	Contacts	Contact Type	Contact Material	Operating Force max. N [lb]	Bar Chart ¹	0.5-14 NPT Conduit	20 mm Conduit
	1NC-1NO	Snap action 	silver	9,8 [2.22]		GLLA01D	GLLC01D
	1NC-1NO	BBM, slow action 	silver	8 [1.8]		GLLA03D	GLLC03D
	1NC-1NO	MBB, slow action 	silver	8 [1.8]		GLLA04D	GLLC04D
	2NC	Slow action 	silver	8 [1.8]		GLLA06D	GLLC06D

¹Contact closed ■; Contact open □. *Positive opening occurs.

MICRO SWITCH Miniature Industrial Limit Switch, GLL Series

Table 12. Top Vertical Roller Lever

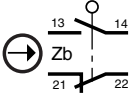
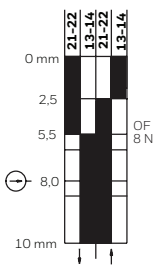
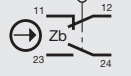
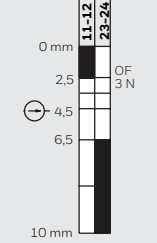
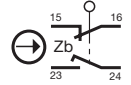
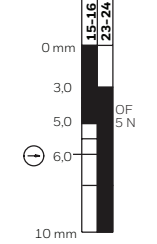
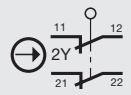
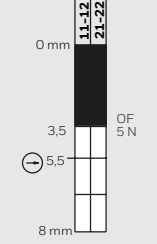
	Contacts	Contact Type	Contact Material	Operating Force max. N [lb]	Bar Chart ¹	0.5-14 NPT Conduit	20 mm Conduit
	1NC-1NO	Snap action 	silver	8 [1.8]		GLLA01F	GLLC01F
	1NC-1NO	BBM, slow action 	silver	3 [0.67]		GLLA03F	GLLC03F
	1NC-1NO	MBB, slow action 	silver	5 [1.12]		GLLA04F	GLLC04F
	2NC	Slow action 	silver	5 [1.12]		GLLA06F	GLLC06F

¹Contact closed ■; Contact open □. *Positive opening occurs.

MICRO SWITCH Miniature Industrial Limit Switch, GLL Series

Figure 2. GLL Side Rotary (A1B) with Fixed Lever Dimensions

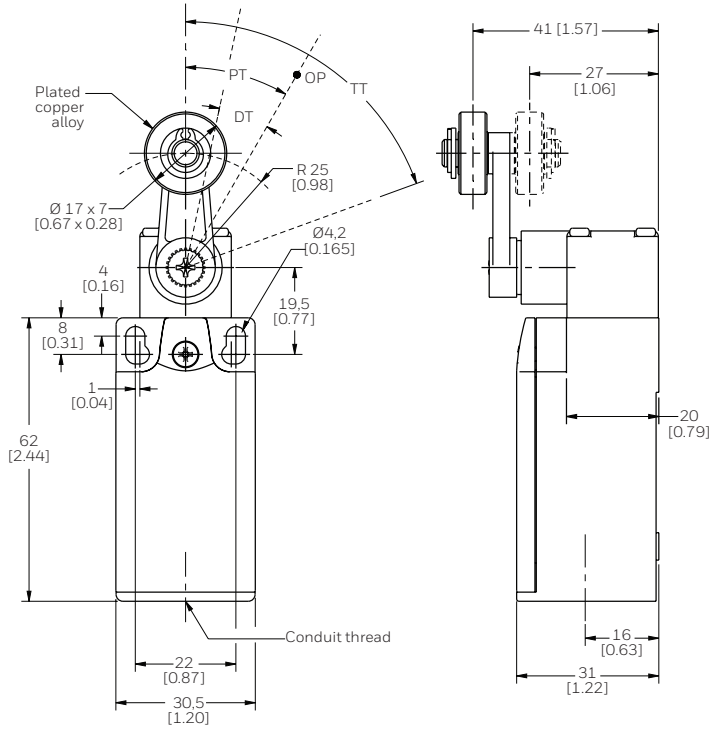

Figure 3. GLL Side Rotary (A3B) with Fixed Lever Dimensions

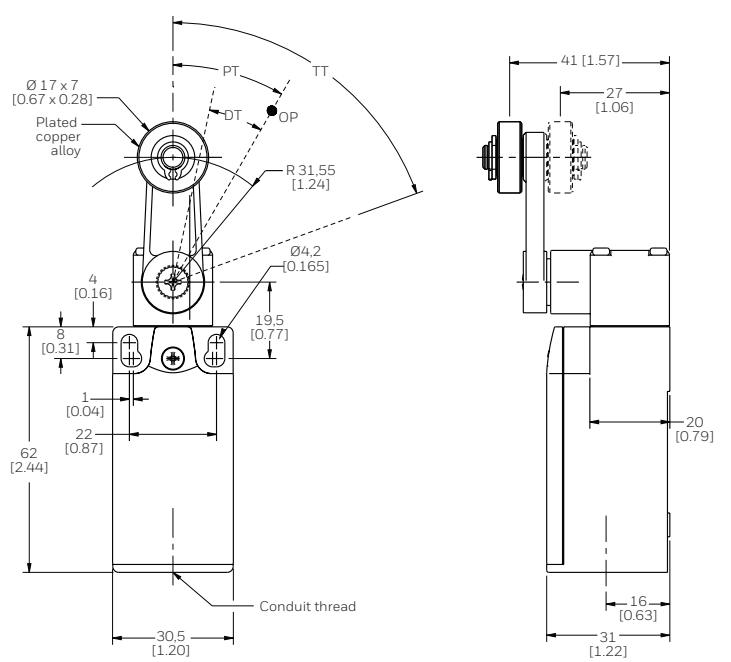

Figure 4. GLL Side Rotary (A2B) with Adj. Lever Dimensions

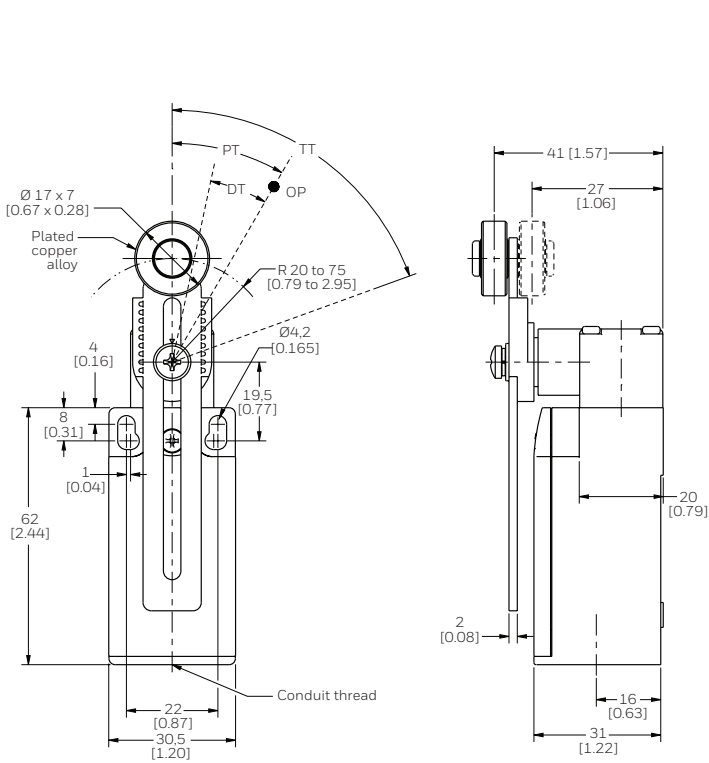
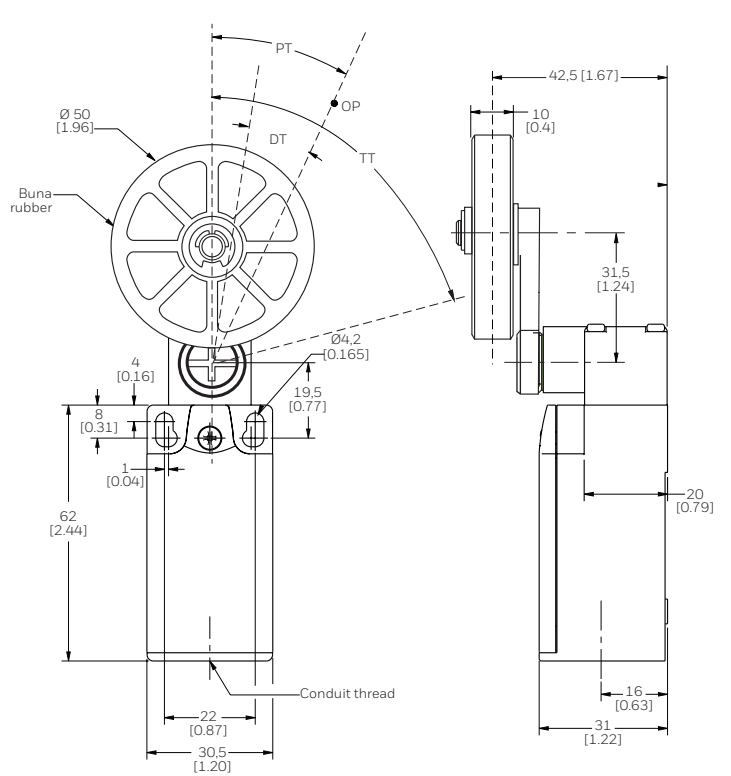

Figure 5. GLL Side Rotary (A1Y) with Roller Lever Dimensions



MICRO SWITCH Miniature Industrial Limit Switch, GLL Series

Figure 6. GLL Side Rotary (A2Y) with Adj. Roller Lever Dimensions

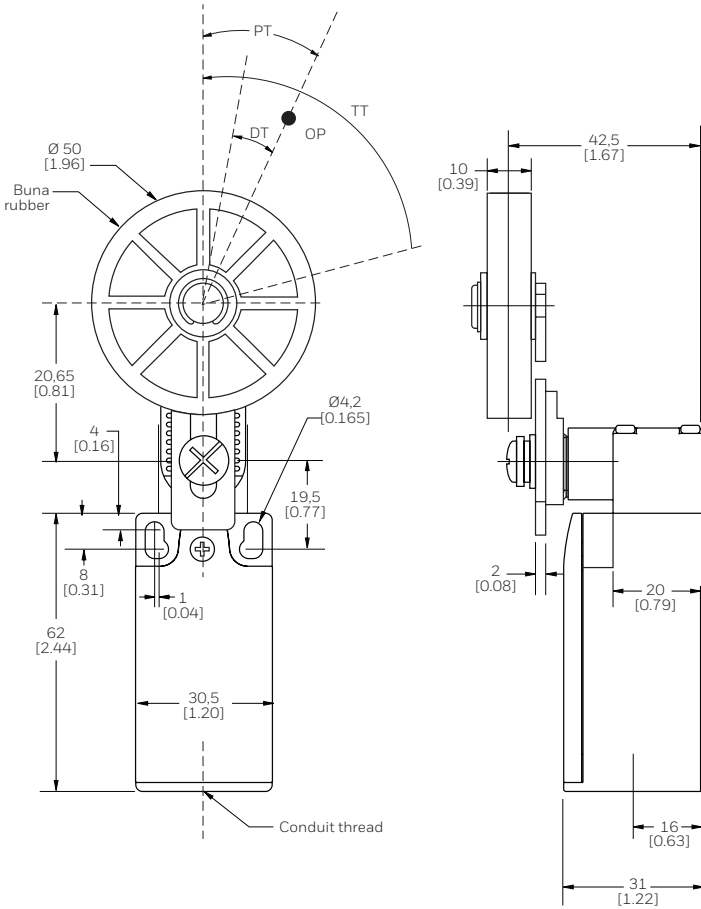

Figure 7. GLL Side Rotary (A4J) with Adj. Rod Lever Dimensions

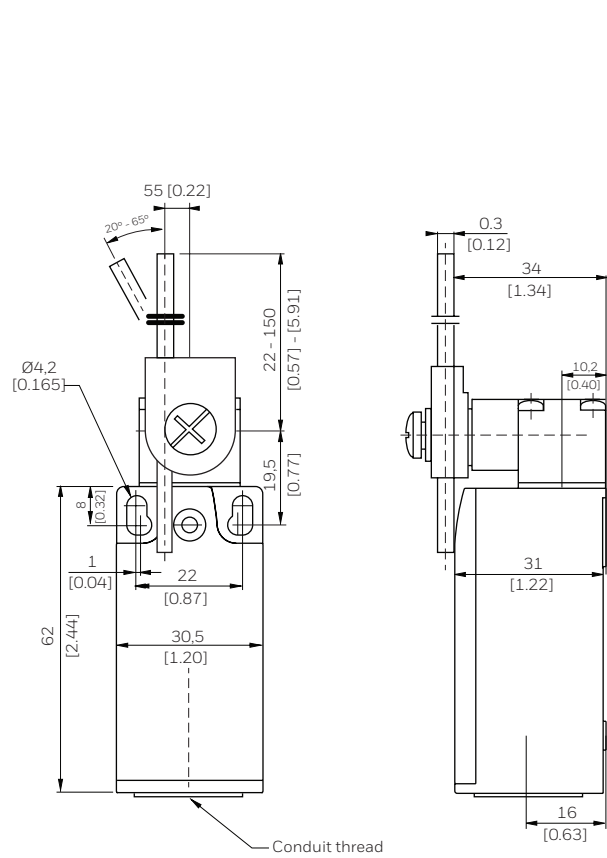

Figure 8. GLL Top Pin Plunger Dimensions

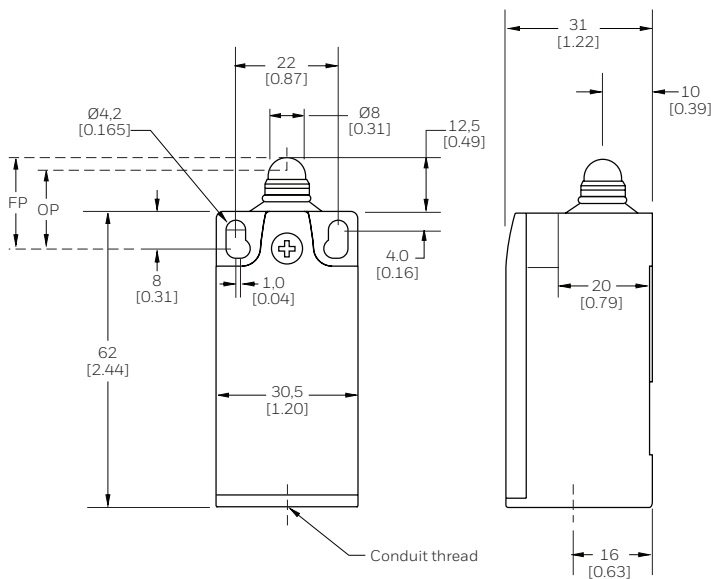
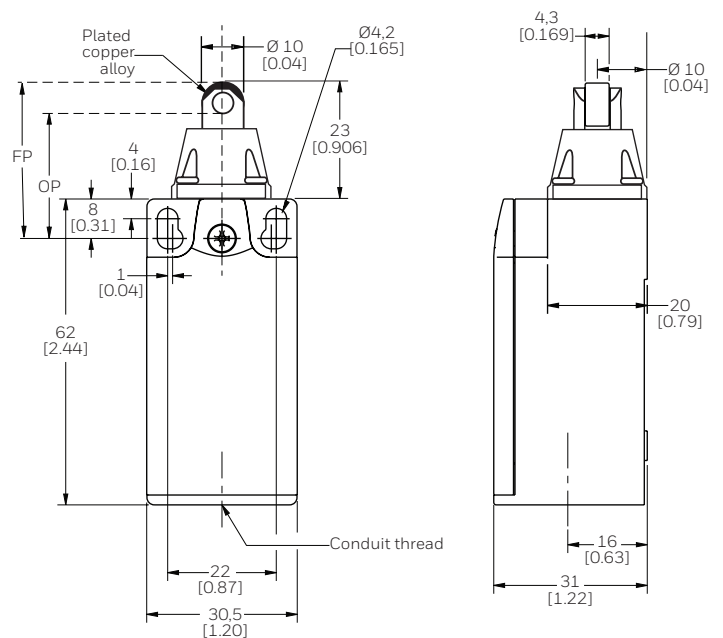

Figure 8. GLL Top Roller Plunger Dimensions



MICRO SWITCH Miniature Industrial Limit Switch, GLL Series

Figure 10. GLL Top Horizontal Roller Lever Dimensions

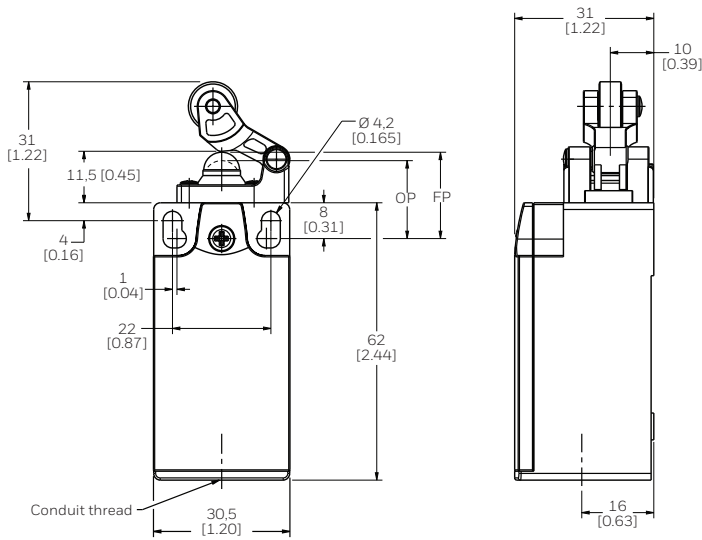
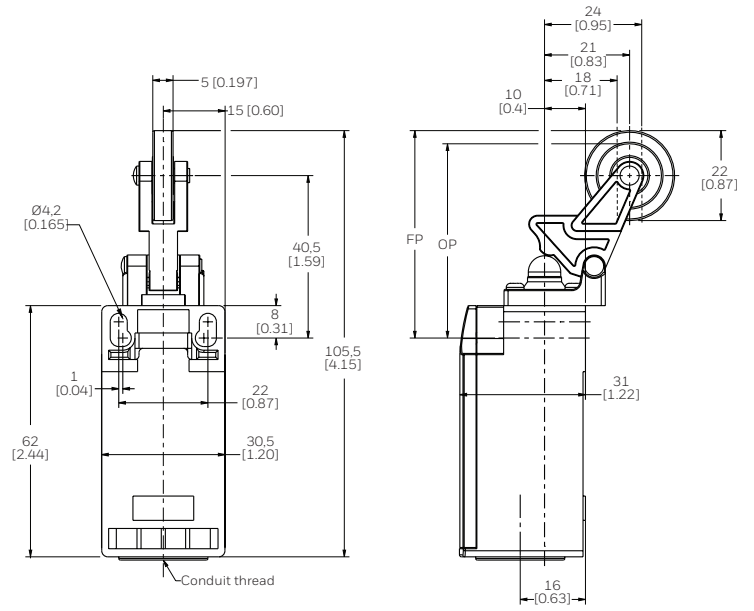

Figure 11. GLL Top Vertical Roller Lever Dimensions



ADDITIONAL MATERIALS

The following associated literature is available on the Honeywell web site at sensing.honeywell.com:

- Product installation instructions
- Product range guide

Find out more

Honeywell serves its customers through a worldwide network of sales offices, representatives and distributors. For application assistance, current specifications, pricing or name of the nearest Authorized Distributor, contact your local sales office. To learn more about Honeywell's sensing and control products, call **+1.815.235.6847** or **1.800.537.6945**, visit **sensing.honeywell.com**, or e-mail inquiries to **info.sc@honeywell.com**

Honeywell Sensing and Internet of Things

9680 Old Bailes Road
Fort Mill, SC 29707
www.honeywell.com

WARNING **PERSONAL INJURY**

DO NOT USE these products as safety or emergency stop devices or in any other application where failure of the product could result in personal injury.

Failure to comply with these instructions could result in death or serious injury.

WARNING **MISUSE OF DOCUMENTATION**

- The information presented in this product sheet is for reference only. Do not use this document as a product installation guide.
- Complete installation, operation, and maintenance information is provided in the instructions supplied with each product.

Failure to comply with these instructions could result in death or serious injury.

Warranty/Remedy

Honeywell warrants goods of its manufacture as being free of defective materials and faulty workmanship during the applicable warranty period. Honeywell's standard product warranty applies unless agreed to otherwise by Honeywell in writing; please refer to your order acknowledgment or consult your local sales office for specific warranty details. If warranted goods are returned to Honeywell during the period of coverage, Honeywell will repair or replace, at its option, without charge those items that Honeywell, in its sole discretion, finds defective. **The foregoing is buyer's sole remedy and is in lieu of all other warranties, expressed or implied, including those of merchantability and fitness for a particular purpose. In no event shall Honeywell be liable for consequential, special, or indirect damages.**

While Honeywell may provide application assistance personally, through our literature and the Honeywell web site, it is buyer's sole responsibility to determine the suitability of the product in the application.

Specifications may change without notice. The information we supply is believed to be accurate and reliable as of this writing. However, Honeywell assumes no responsibility for its use.

Honeywell