



Chipsmall Limited consists of a professional team with an average of over 10 year of expertise in the distribution of electronic components. Based in Hongkong, we have already established firm and mutual-benefit business relationships with customers from,Europe,America and south Asia,supplying obsolete and hard-to-find components to meet their specific needs.

With the principle of “Quality Parts,Customers Priority,Honest Operation,and Considerate Service”,our business mainly focus on the distribution of electronic components. Line cards we deal with include Microchip,ALPS,ROHM,Xilinx,Pulse,ON,Everlight and Freescale. Main products comprise IC,Modules,Potentiometer,IC Socket,Relay,Connector.Our parts cover such applications as commercial,industrial, and automotives areas.

We are looking forward to setting up business relationship with you and hope to provide you with the best service and solution. Let us make a better world for our industry!



Contact us

Tel: +86-755-8981 8866 Fax: +86-755-8427 6832

Email & Skype: info@chipsmall.com Web: www.chipsmall.com

Address: A1208, Overseas Decoration Building, #122 Zhenhua RD., Futian, Shenzhen, China



Series: SharkFin

Description: 4G/WiFi/Active GNSS Direct Mount Antenna

PART NUMBER: GNSSDM700/5800SSS



Features:

- 3-Feeds (4G, WiFi, GNSS)
- GNSS Active Antenna
 - LNA gain 30dB
 - Pre and post LNA filtering
- Direct mount
- Connector SMA Male
- Cable 17 feet
- RoHS compliant

Applications:

- 4G LTE 698-2700MHz
- WiFi dualband 2.4/5GHz
- DSRC 5850-5925GHz
- GNSS (Beidou, GPS, Galileo, Glonass)
- Vehicular mounting
- Asset Tracking, Navigation, Fleet Management
- Mobile and Fixed broadband

All dimensions are in mm / inches

Issue: 1709

In the effort to improve our products, we reserve the right to make changes judged to be necessary.

CONFIDENTIAL AND PROPRIETARY INFORMATION

This document contains confidential and proprietary information of Pulse Electronics, Inc. (Pulse) and is protected by copyright, trade secret and other state and federal laws. Its receipt or possession does not convey any rights to reproduce, disclose its contents, or to manufacture, use or sell anything it may describe. Reproduction, disclosure or use without specific written authorization of Pulse is strictly forbidden.

For more information:

Pulse Worldwide Headquarters
15255 Innovation Drive #100
San Diego, CA 92128
USA
Tel: 1-858-674-8100

Pulse/Larsen Antennas
18110 SE 34th St Bldg 2 Suite 250
Vancouver, WA 98683
USA
Tel: 1-360-944-7551

Europe Headquarters
Pulse GmbH & Do, KG
Zeppelinstrasse 15
Herrenberg, Germany
Tel: 49 7032 7806 0

Pulse (Suzhou) Wireless Products Co, Inc.
99 Huo Ju Road(#29 Bldg,4th Phase
Suzhou New District
Jiangsu Province, Suzhou 215009 PR China
Tel: 86 512 6807 9998



Series: SharkFin

Description: 4G/WiFi/Active GNSS Direct Mount Antenna

PART NUMBER: GNSSDM700/5800SSS

ELECTRICAL SPECIFICATIONS

Frequency(LTE Cable)	698-960/1710-2170/2300-2700	MHz
Frequency(WiFi cable)	2400-2485/5150-5925	MHz
	1561.098 ± 2.046/	
Frequency(GNSS cable)	1575.42 ± 1.023/	MHz
	1602.5625 ± 4	
Nominal Impedance	50	Ω
VSWR (LTE)*	2.5:1	Max
VSWR (WiFi/GNSS)*	2:1	Max
Peak Gain (LTE,698-960MHz,Typical)**	3.0	dBi
Peak Gain (LTE,1710-2700MHz,Typical)**	4.5	dBi
Peak Gain (WiFi, 2400-2500MHz,Typical)**	4.1	dBi
Peak Gain (WiFi, 5150-5925MHz,Typical)**	5.9	dBi
Efficiency (LTE,698-960MHz,Typical)**	83	%
Efficiency (LTE,1710-2700MHz,Typical)**	82	%
Efficiency (WiFi,2400-2500MHz,Typical)**	82	%
Efficiency (WiFi,5150-5925MHz,Typical)**	54	%
HPBW / Horizontal Plane (LTE/WiFi)**		Omni
HPBW / Vertical Plane (LTE, 698-960MHz, Typical)**		52°
HPBW / Vertical Plane (LTE,1710-2700MHz, Typical)**		35°
HPBW / Vertical Plane (WiFi, 2400-2485MHz, Typical)**		32°
HPBW / Vertical Plane (WiFi,5150-5925MHz, Typical)**		25°
Polarization (LTE/WiFi)		Vertical
Polarization (GNSS)		RHCP
Power Withstanding (LTE, 698-960MHz)		100 W
Power Withstanding (LTE, 1710-2700MHz)		20 W
Power Withstanding (WiFi, 2400-5925MHz)		20 W

Issue: 1709

In the effort to improve our products, we reserve the right to make changes judged to be necessary.

CONFIDENTIAL AND PROPRIETARY INFORMATION

This document contains confidential and proprietary information of Pulse Electronics, Inc. (Pulse) and is protected by copyright, trade secret and other state and federal laws. Its receipt or possession does not convey any rights to reproduce, disclose its contents, or to manufacture, use or sell anything it may describe. Reproduction, disclosure or use without specific written authorization of Pulse is strictly forbidden.

Description: 4G/WiFi/Active GNSS Direct Mount Antenna

Series: SharkFin

PART NUMBER: GNSSDM700/5800SSS

RHCP Peak Gain (Radiating element, Typical)***	1 dBic
Gain (LNA gain)	30 dB ± 2 dB
Out of Band Rejection	
698 MHz	>70 dB
960MHz	>65 dB
1710MHz	>60 dB
2170MHz	>65 dB
2400MHz	>65 dB
2700MHz	>65 dB
Noise Figure	<2.4 dB
Operating Voltage	3.3-5 Vdc±0.5V
Current Consumption	9 mA± 2 mA

* Tested with 5.18m cable and with 500mm ground plane

**Tested with 200mm cable and with 500mm ground plane

***Tested with 70X70mm ground plane

Issue: 1709

In the effort to improve our products, we reserve the right to make changes judged to be necessary.

CONFIDENTIAL AND PROPRIETARY INFORMATION

This document contains confidential and proprietary information of Pulse Electronics, Inc. (Pulse) and is protected by copyright, trade secret and other state and federal laws. Its receipt or possession does not convey any rights to reproduce, disclose its contents, or to manufacture, use or sell anything it may describe. Reproduction, disclosure or use without specific written authorization of Pulse is strictly forbidden.

Description: 4G/WiFi/Active GNSS Direct Mount Antenna

Series: SharkFin

PART NUMBER: GNSSDM700/5800SSS

MECHANICAL SPECIFICATIONS

Overall Length	3.5 H x Ø4.26 /88.3 x Ø108[in/mm]
Weight	470g
Antenna Color	BLACK or WHITE
Connector type	SMA MALE
Cable type	RG58/RG174[GNSS/ LTE&WLAN]
Cable length	17' / 5.18m

ENVIRONMENTAL SPECIFICATIONS

Operating Temperature	-40/+85 ° C
Storage Temperature	-40/+85 ° C
Ingress Protection	IP65
Wind-loading	120km/h
RoHS Compliant	Yes

Series: SharkFin

Description: 4G/WiFi/Active GNSS Direct Mount Antenna

PART NUMBER: GNSSDM700/5800SSS

MECHANICAL DRAWING

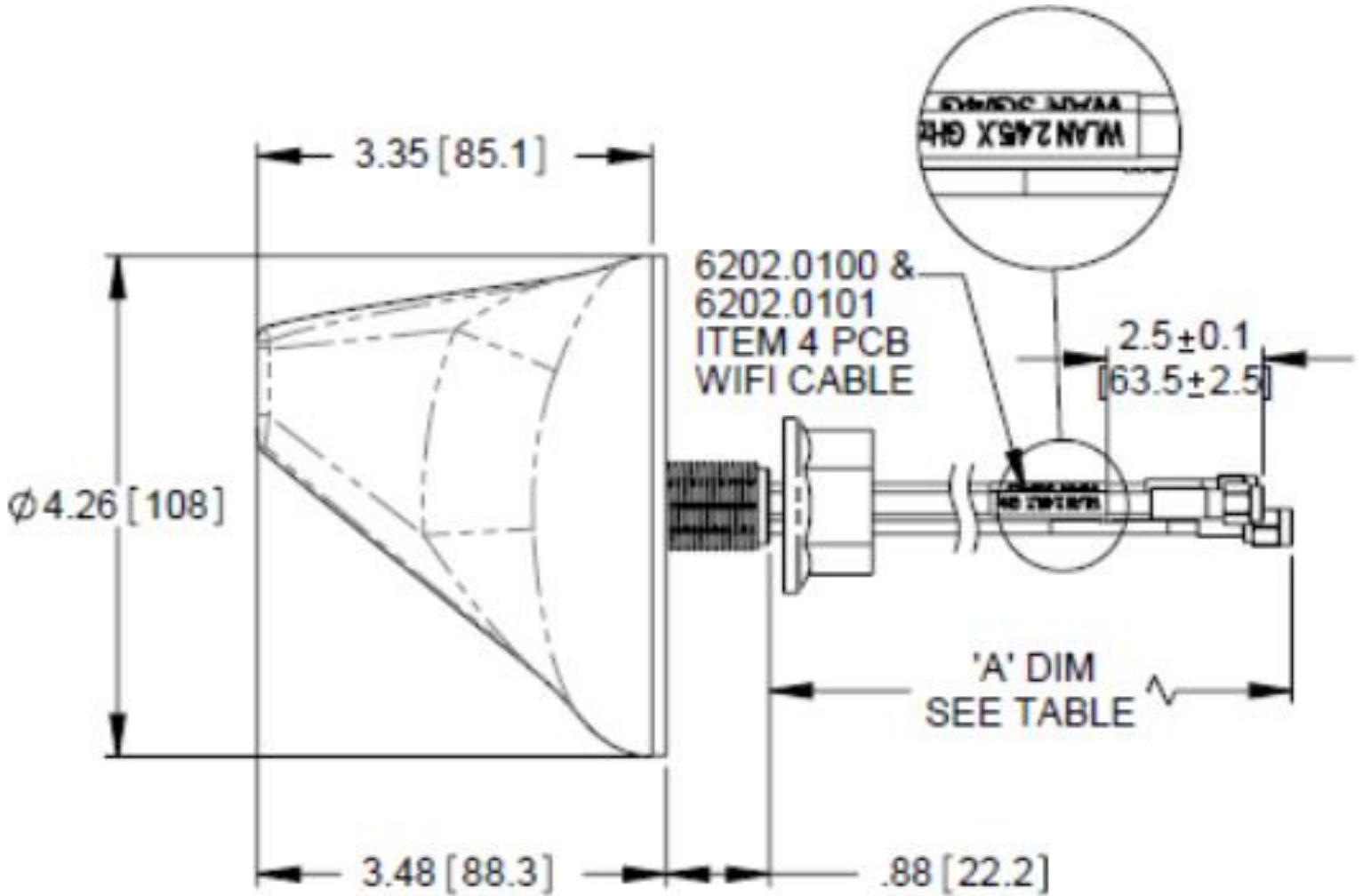

Issue: 1709

In the effort to improve our products, we reserve the right to make changes judged to be necessary.

CONFIDENTIAL AND PROPRIETARY INFORMATION

This document contains confidential and proprietary information of Pulse Electronics, Inc. (Pulse) and is protected by copyright, trade secret and other state and federal laws. Its receipt or possession does not convey any rights to reproduce, disclose its contents, or to manufacture, use or sell anything it may describe. Reproduction, disclosure or use without specific written authorization of Pulse is strictly forbidden.

Series: SharkFin

Description: 4G/WiFi/Active GNSS Direct
Mount Antenna

PART NUMBER: GNSSDM700/5800SSS

Test Setup

- * VSWR is tested with 5.18m cable and with 500mm ground plane
- ** Radiation performance is tested with 200mm cable and with 500mm ground plane
- *** GNSS module is tested with 70X70mm ground plane

Series: SharkFin

Description: 4G/WiFi/Active GNSS Direct Mount Antenna

PART NUMBER: GNSSDM700/5800SSS

CHARTS

VSWR of LTE

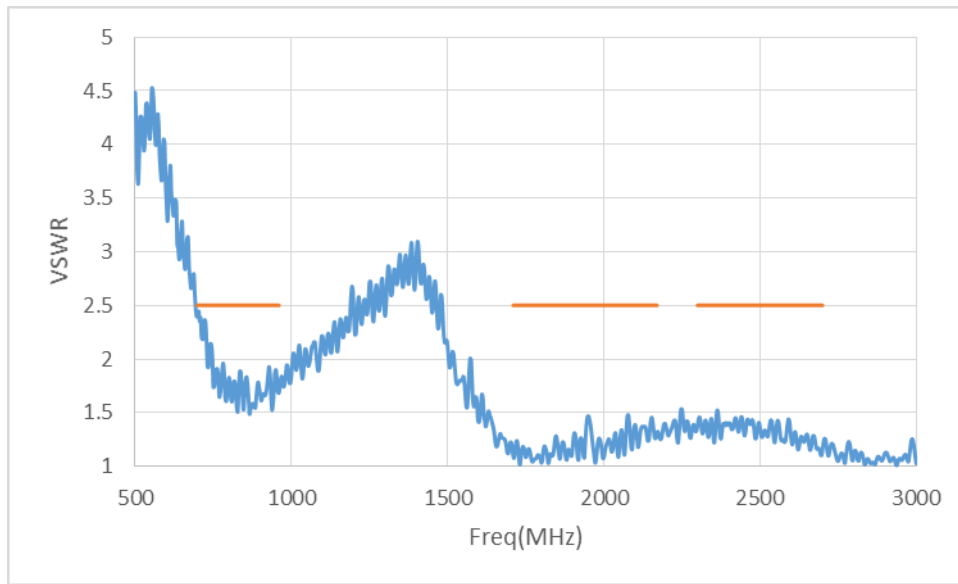

VSWR of WiFi

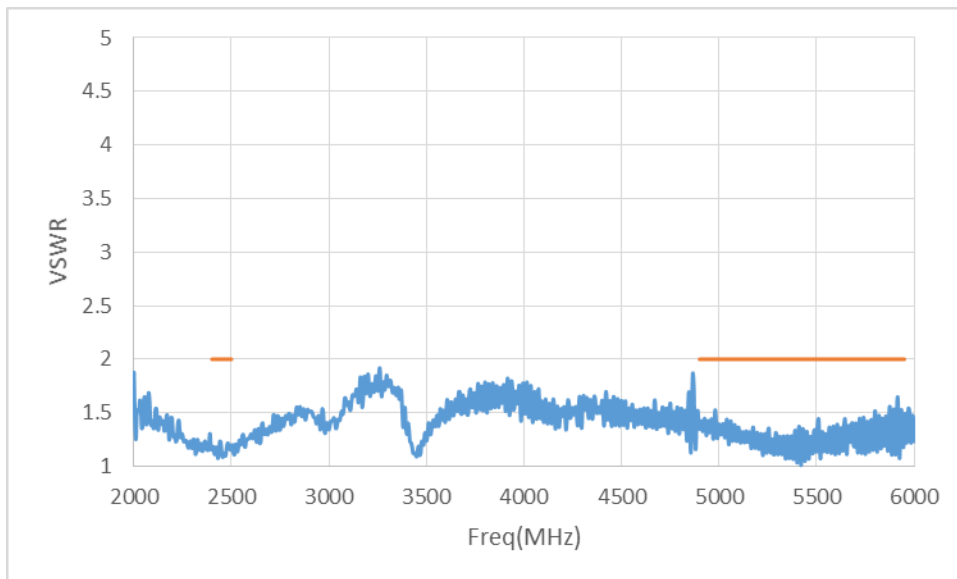

Issue: 1709

In the effort to improve our products, we reserve the right to make changes judged to be necessary.

CONFIDENTIAL AND PROPRIETARY INFORMATION

This document contains confidential and proprietary information of Pulse Electronics, Inc. (Pulse) and is protected by copyright, trade secret and other state and federal laws. Its receipt or possession does not convey any rights to reproduce, disclose its contents, or to manufacture, use or sell anything it may describe. Reproduction, disclosure or use without specific written authorization of Pulse is strictly forbidden.

Description: 4G/WiFi/Active GNSS Direct Mount Antenna

Series: SharkFin

PART NUMBER: GNSSDM700/5800SSS

CHARTS

Radiation Efficiency of LTE

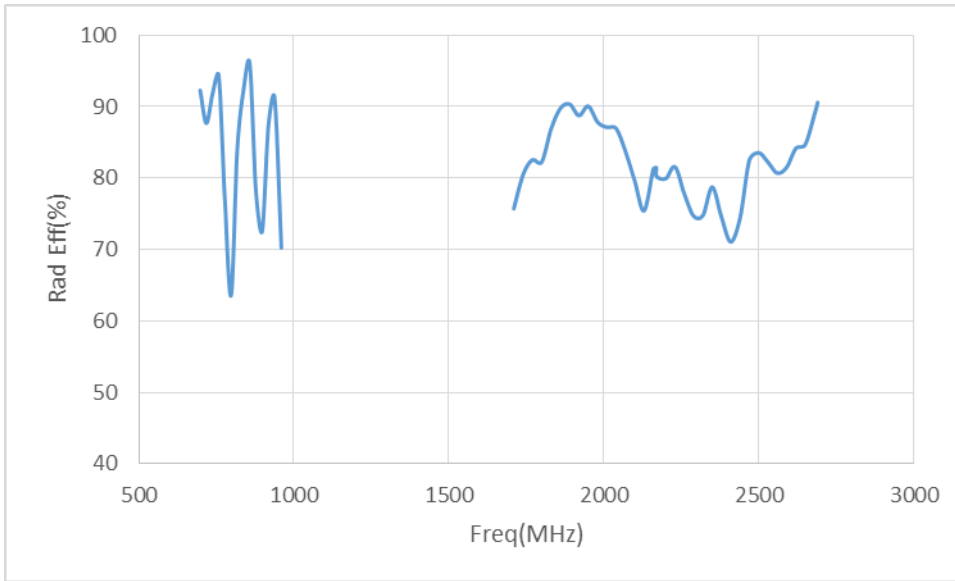

Radiation Efficiency of WiFi

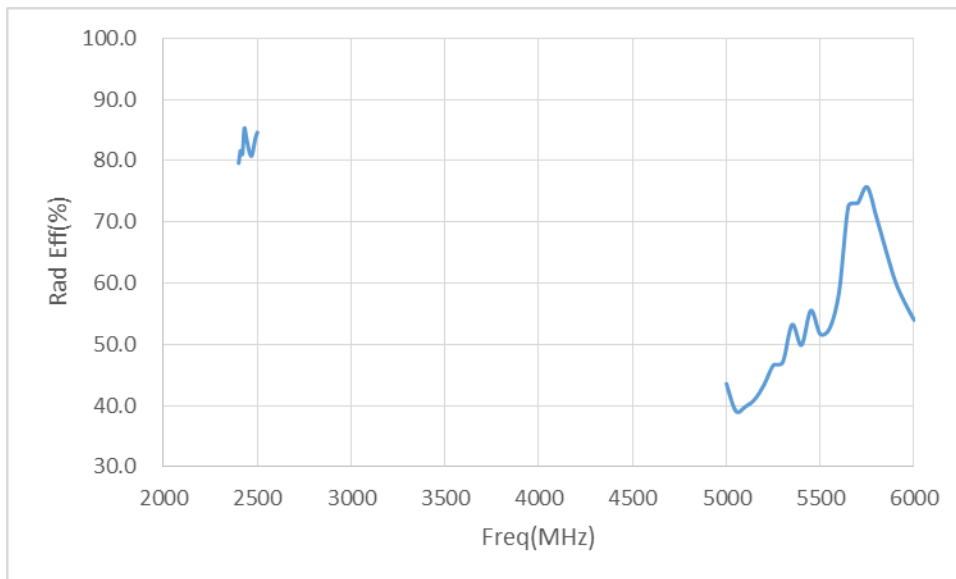

Issue: 1709

In the effort to improve our products, we reserve the right to make changes judged to be necessary.

CONFIDENTIAL AND PROPRIETARY INFORMATION

This document contains confidential and proprietary information of Pulse Electronics, Inc. (Pulse) and is protected by copyright, trade secret and other state and federal laws. Its receipt or possession does not convey any rights to reproduce, disclose its contents, or to manufacture, use or sell anything it may describe. Reproduction, disclosure or use without specific written authorization of Pulse is strictly forbidden.

Description: 4G/WiFi/Active GNSS Direct Mount Antenna

Series: SharkFin

PART NUMBER: GNSSDM700/5800SSS

CHARTS

Peak Gain of LTE

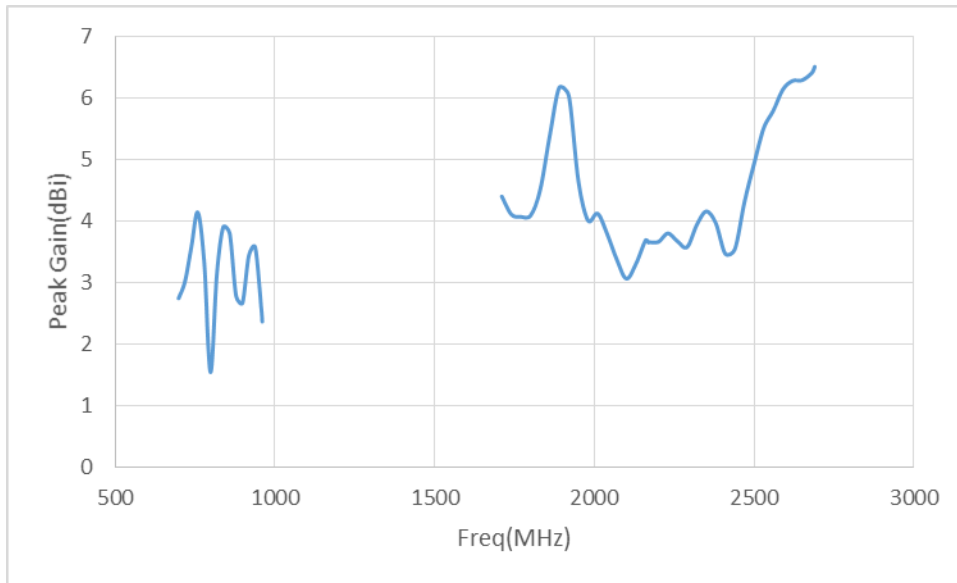

Peak Gain of WiFi

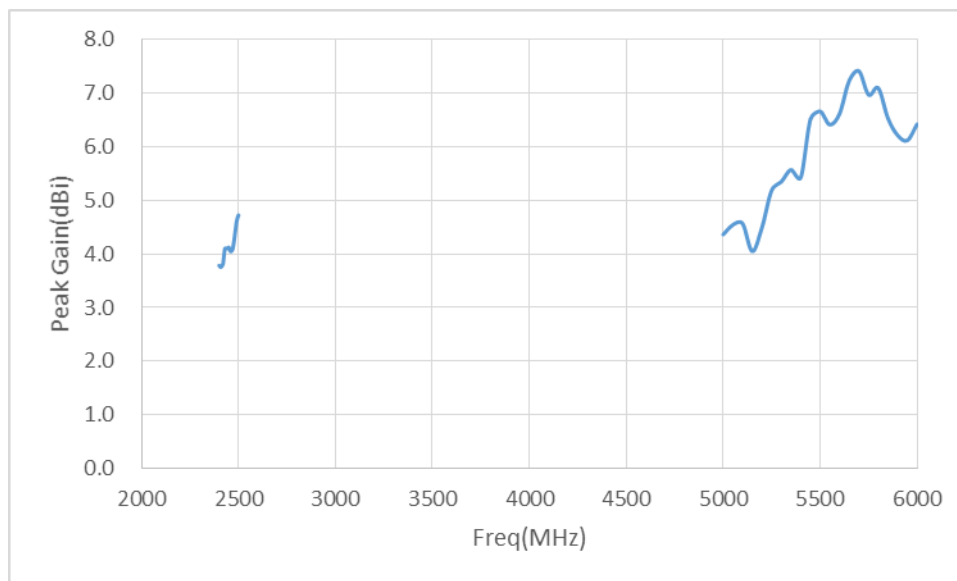

Issue: 1709

In the effort to improve our products, we reserve the right to make changes judged to be necessary.

CONFIDENTIAL AND PROPRIETARY INFORMATION

This document contains confidential and proprietary information of Pulse Electronics, Inc. (Pulse) and is protected by copyright, trade secret and other state and federal laws. Its receipt or possession does not convey any rights to reproduce, disclose its contents, or to manufacture, use or sell anything it may describe. Reproduction, disclosure or use without specific written authorization of Pulse is strictly forbidden.

Description: 4G/WiFi/Active GNSS Direct Mount Antenna

Series: SharkFin

PART NUMBER: GNSSDM700/5800SSS

CHARTS

LTE antenna X-Y plane radiation pattern at LTE low band

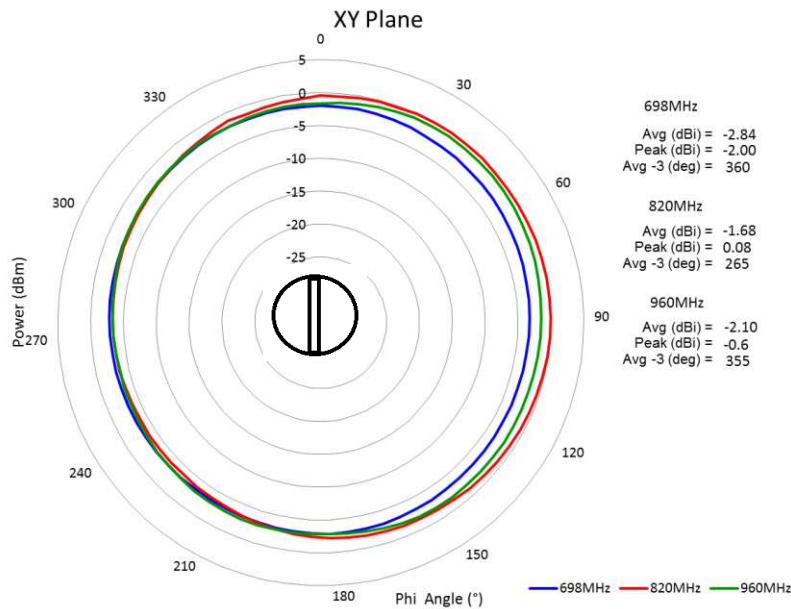

LTE antenna Z-X plane radiation pattern at LTE low band

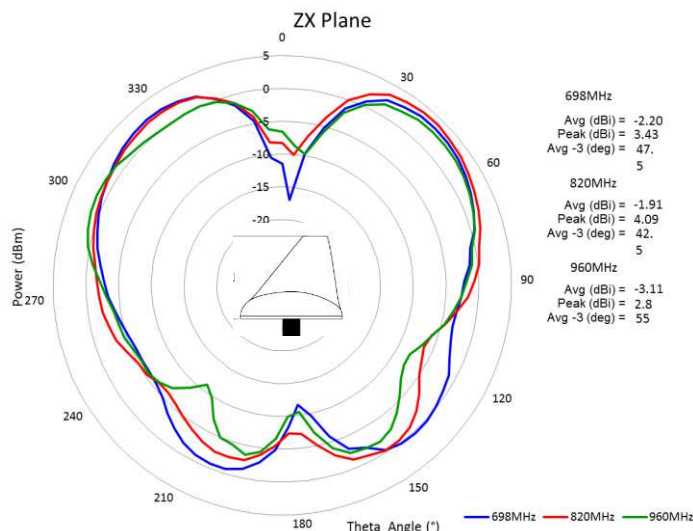

Issue: 1709

In the effort to improve our products, we reserve the right to make changes judged to be necessary.

CONFIDENTIAL AND PROPRIETARY INFORMATION

This document contains confidential and proprietary information of Pulse Electronics, Inc. (Pulse) and is protected by copyright, trade secret and other state and federal laws. Its receipt or possession does not convey any rights to reproduce, disclose its contents, or to manufacture, use or sell anything it may describe. Reproduction, disclosure or use without specific written authorization of Pulse is strictly forbidden.

Description: 4G/WiFi/Active GNSS Direct Mount Antenna

Series: SharkFin

PART NUMBER: GNSSDM700/5800SSS

CHARTS

LTE antenna Y-Z plane radiation pattern at LTE low band

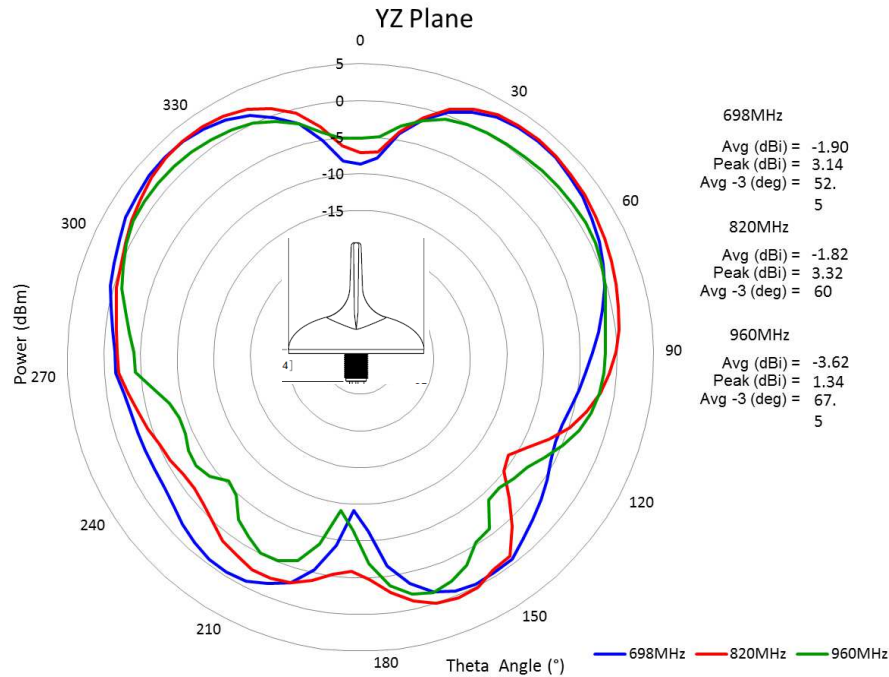

LTE antenna X-Y plane radiation pattern at LTE high band

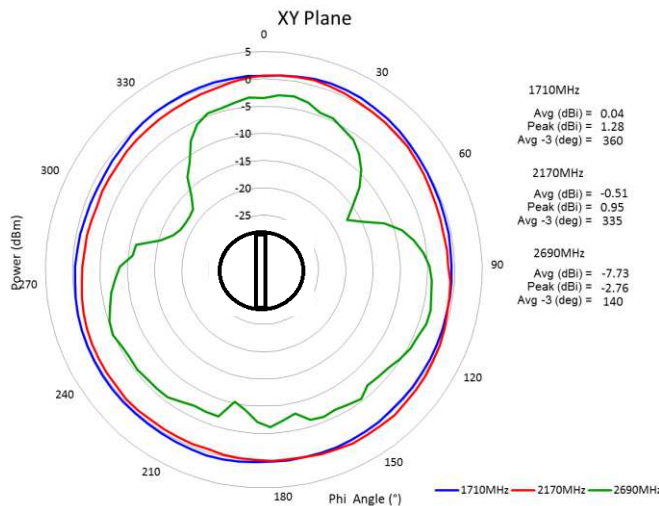

Issue: 1709

In the effort to improve our products, we reserve the right to make changes judged to be necessary.

CONFIDENTIAL AND PROPRIETARY INFORMATION

This document contains confidential and proprietary information of Pulse Electronics, Inc. (Pulse) and is protected by copyright, trade secret and other state and federal laws. Its receipt or possession does not convey any rights to reproduce, disclose its contents, or to manufacture, use or sell anything it may describe. Reproduction, disclosure or use without specific written authorization of Pulse is strictly forbidden.

Description: 4G/WiFi/Active GNSS Direct Mount Antenna

Series: SharkFin

PART NUMBER: GNSSDM700/5800SSS

CHARTS

LTE antenna Z-X plane radiation pattern at LTE high band

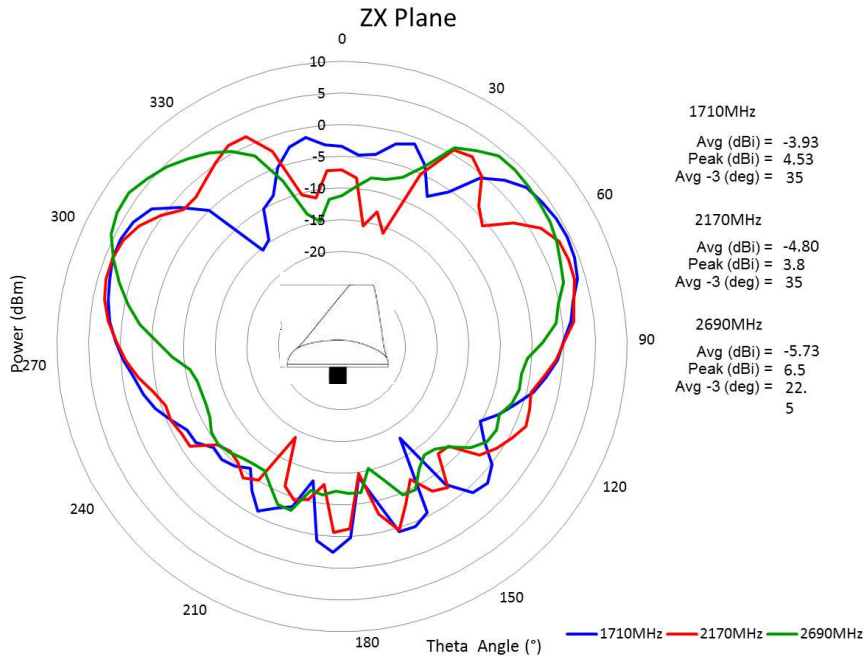

LTE antenna Y-Z plane radiation pattern at LTE high band

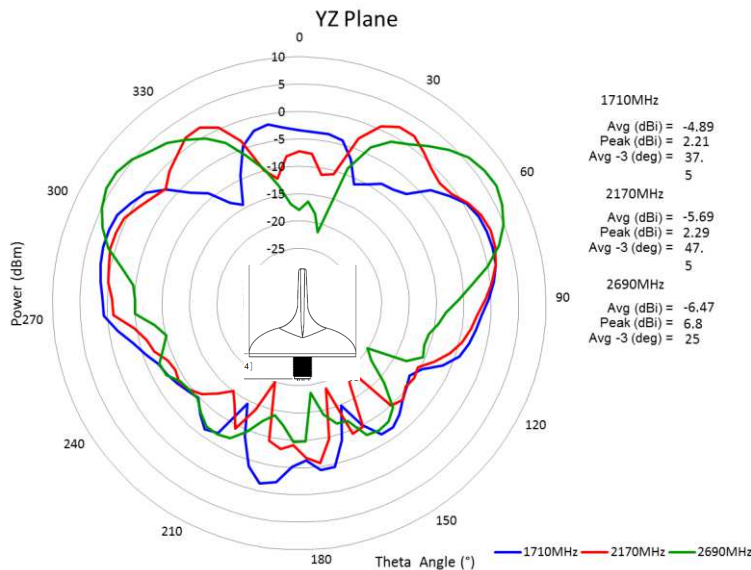

Issue: 1709

In the effort to improve our products, we reserve the right to make changes judged to be necessary.

CONFIDENTIAL AND PROPRIETARY INFORMATION

This document contains confidential and proprietary information of Pulse Electronics, Inc. (Pulse) and is protected by copyright, trade secret and other state and federal laws. Its receipt or possession does not convey any rights to reproduce, disclose its contents, or to manufacture, use or sell anything it may describe. Reproduction, disclosure or use without specific written authorization of Pulse is strictly forbidden.

Description: 4G/WiFi/Active GNSS Direct Mount Antenna

Series: SharkFin

PART NUMBER: GNSSDM700/5800SSS

CHARTS

WiFi antenna X-Y plane radiation pattern at WiFi low band

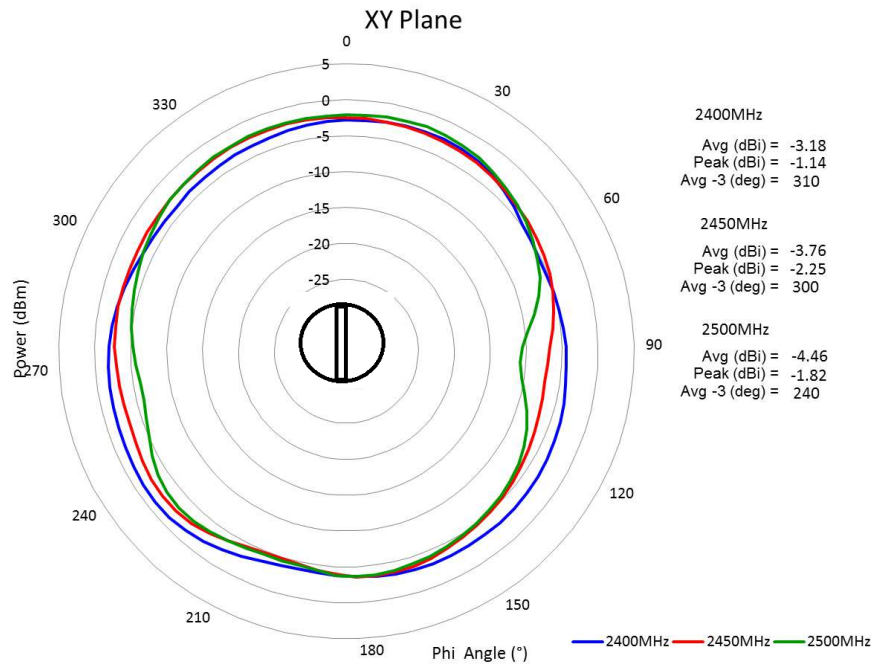

WiFi antenna Z-X plane radiation pattern at WiFi low band

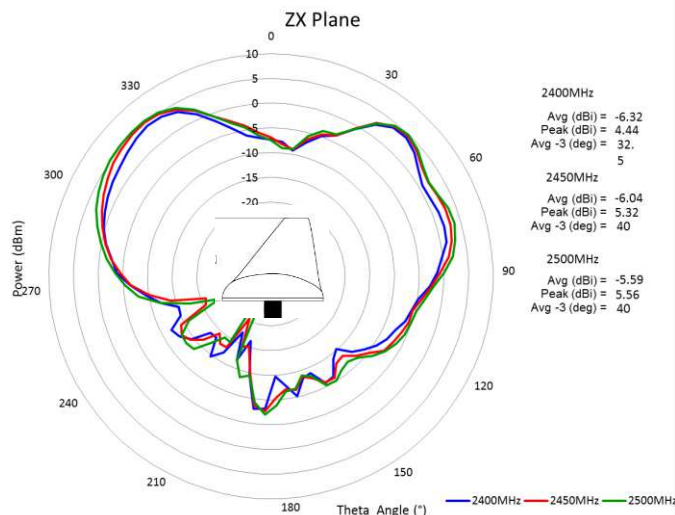

Issue: 1709

In the effort to improve our products, we reserve the right to make changes judged to be necessary.

CONFIDENTIAL AND PROPRIETARY INFORMATION

This document contains confidential and proprietary information of Pulse Electronics, Inc. (Pulse) and is protected by copyright, trade secret and other state and federal laws. Its receipt or possession does not convey any rights to reproduce, disclose its contents, or to manufacture, use or sell anything it may describe. Reproduction, disclosure or use without specific written authorization of Pulse is strictly forbidden.

CHARTS

WiFi antenna Y-Z plane radiation pattern at WiFi low band

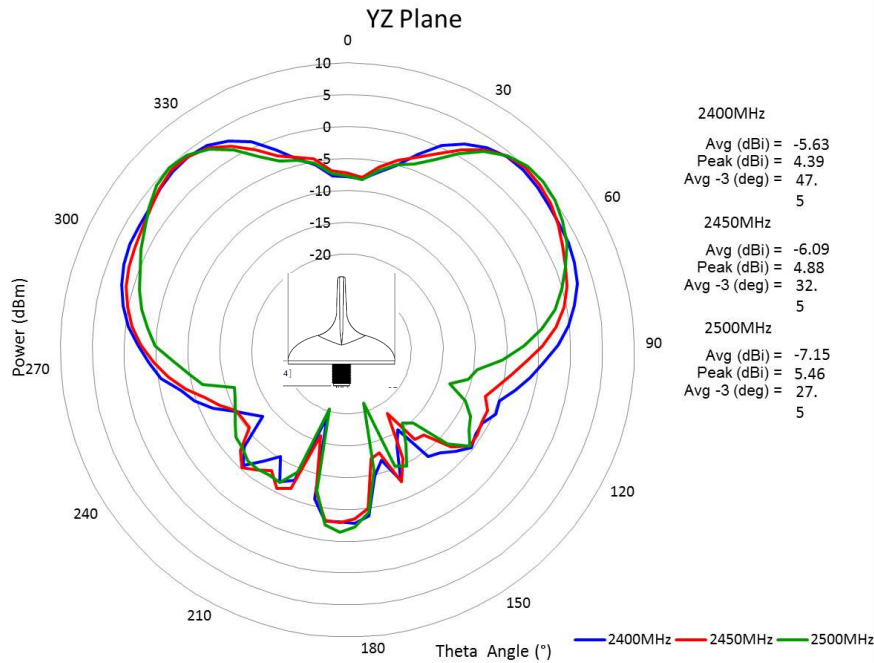

WiFi antenna X-Y plane radiation pattern at WiFi high band

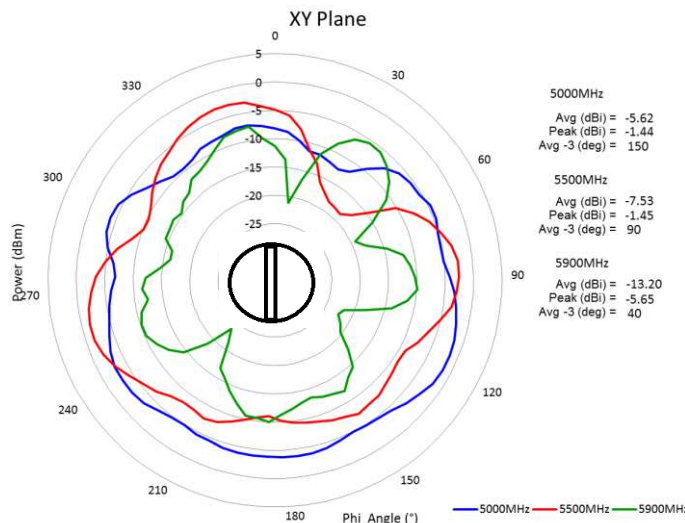

Issue: 1709

In the effort to improve our products, we reserve the right to make changes judged to be necessary.

CONFIDENTIAL AND PROPRIETARY INFORMATION

This document contains confidential and proprietary information of Pulse Electronics, Inc. (Pulse) and is protected by copyright, trade secret and other state and federal laws. Its receipt or possession does not convey any rights to reproduce, disclose its contents, or to manufacture, use or sell anything it may describe. Reproduction, disclosure or use without specific written authorization of Pulse is strictly forbidden.

Description: 4G/WiFi/Active GNSS Direct Mount Antenna

Series: SharkFin

PART NUMBER: GNSSDM700/5800SSS

CHARTS

WiFi antenna Z-X plane radiation pattern at WiFi high band

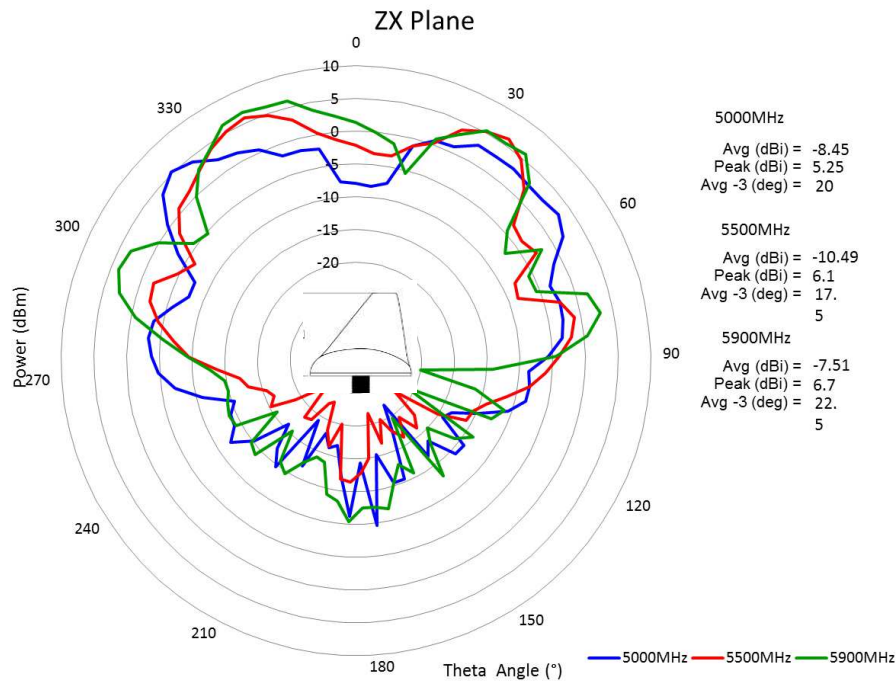

WiFi antenna Y-Z plane radiation pattern at WiFi high band

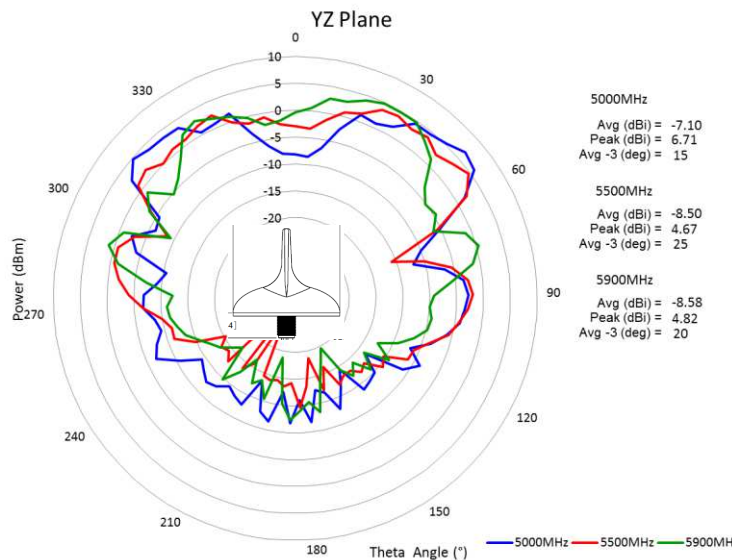

Issue: 1709

In the effort to improve our products, we reserve the right to make changes judged to be necessary.

CONFIDENTIAL AND PROPRIETARY INFORMATION

This document contains confidential and proprietary information of Pulse Electronics, Inc. (Pulse) and is protected by copyright, trade secret and other state and federal laws. Its receipt or possession does not convey any rights to reproduce, disclose its contents, or to manufacture, use or sell anything it may describe. Reproduction, disclosure or use without specific written authorization of Pulse is strictly forbidden.

Description: 4G/WiFi/Active GNSS Direct Mount Antenna

Series: SharkFin

PART NUMBER: GNSSDM700/5800SSS

CHARTS

LNA Gain and out-of-band rejection

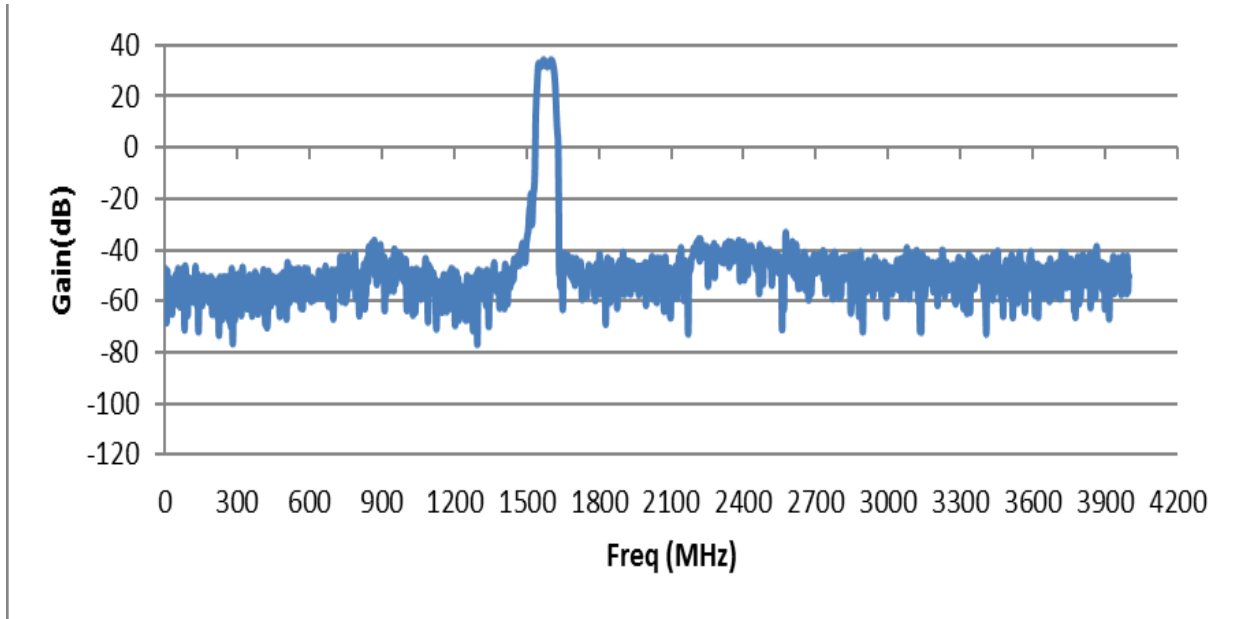

Radiation Pattern (70mm x 70mm ground plane) GPS & Galileo

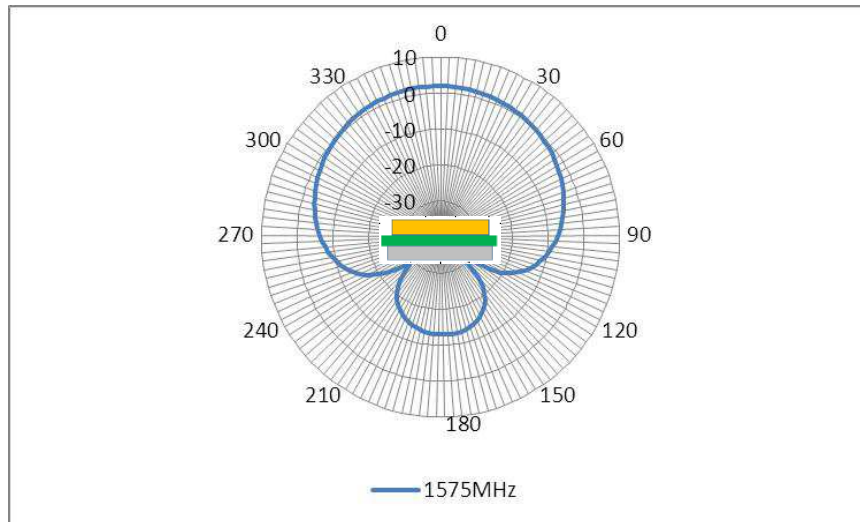

Issue: 1709

In the effort to improve our products, we reserve the right to make changes judged to be necessary.

CONFIDENTIAL AND PROPRIETARY INFORMATION

This document contains confidential and proprietary information of Pulse Electronics, Inc. (Pulse) and is protected by copyright, trade secret and other state and federal laws. Its receipt or possession does not convey any rights to reproduce, disclose its contents, or to manufacture, use or sell anything it may describe. Reproduction, disclosure or use without specific written authorization of Pulse is strictly forbidden.

Series: SharkFin

Description: 4G/WiFi/Active GNSS Direct Mount Antenna

PART NUMBER: GNSSDM700/5800SSS

CHARTS

Radiation Pattern (70mm x 70mm ground plane) GLONASS

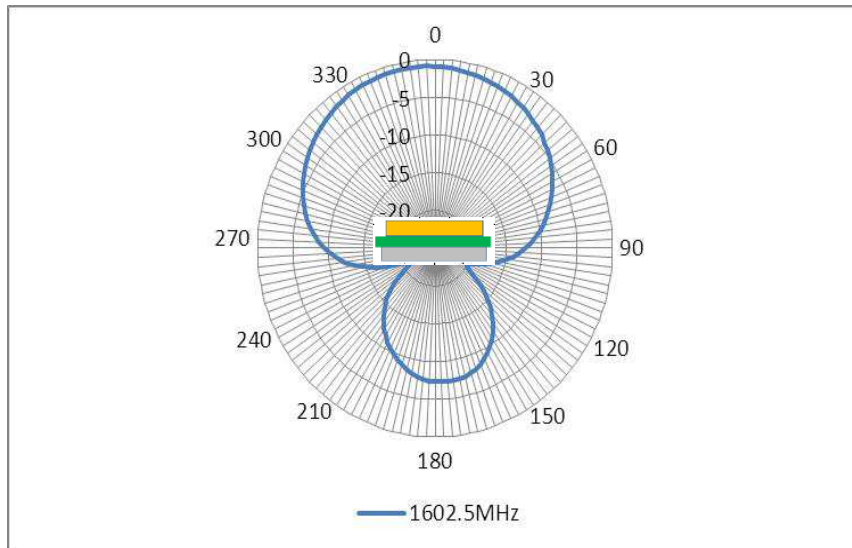

Radiation Pattern (70mm x 70mm ground plane) BD2

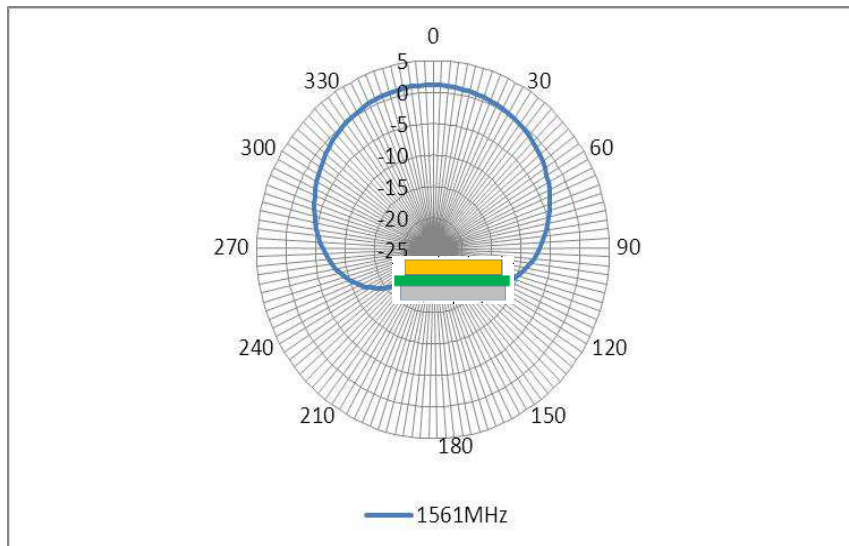

Issue: 1709

In the effort to improve our products, we reserve the right to make changes judged to be necessary.

CONFIDENTIAL AND PROPRIETARY INFORMATION

This document contains confidential and proprietary information of Pulse Electronics, Inc. (Pulse) and is protected by copyright, trade secret and other state and federal laws. Its receipt or possession does not convey any rights to reproduce, disclose its contents, or to manufacture, use or sell anything it may describe. Reproduction, disclosure or use without specific written authorization of Pulse is strictly forbidden.

Series: SharkFin

Description: 4G/WiFi/Active GNSS Direct
Mount Antenna

PART NUMBER: GNSSDM700/5800SSS

PACKAGING

1pcs antennas per PE bag

12pcs antenna per package box

Package box: 400mm*300mm*30mm