



Chipsmall Limited consists of a professional team with an average of over 10 year of expertise in the distribution of electronic components. Based in Hongkong, we have already established firm and mutual-benefit business relationships with customers from,Europe,America and south Asia,supplying obsolete and hard-to-find components to meet their specific needs.

With the principle of “Quality Parts,Customers Priority,Honest Operation,and Considerate Service”,our business mainly focus on the distribution of electronic components. Line cards we deal with include Microchip,ALPS,ROHM,Xilinx,Pulse,ON,Everlight and Freescale. Main products comprise IC,Modules,Potentiometer,IC Socket,Relay,Connector.Our parts cover such applications as commercial,industrial, and automotives areas.

We are looking forward to setting up business relationship with you and hope to provide you with the best service and solution. Let us make a better world for our industry!



## Contact us

Tel: +86-755-8981 8866 Fax: +86-755-8427 6832

Email & Skype: info@chipsmall.com Web: www.chipsmall.com

Address: A1208, Overseas Decoration Building, #122 Zhenhua RD., Futian, Shenzhen, China



# GP-A SERIES

Related Information

- General terms and conditions..... F-7
- Sensor selection guide ..... P.1055~
- Glossary of terms..... P.1493
- General precautions ..... P.1501



## Resolution 0.04 % F.S., Linearity $\pm 0.5$ % F.S., IP67G environment resistance

### Accurate measurement of minute displacements

Minute displacement of metallic objects can be accurately measured with a resolution of 0.04 % F.S.

[ GP-A5S (For 1 mm 0.039 in sensing type)  
Resolution: 0.4  $\mu$ m 0.016 mil ]

### Linearity $\pm 0.5$ % F.S.

Displacement is accurately output since it incorporates a high accuracy linearity correction circuit.

### ENVIRONMENTAL RESISTANCE

#### The sensor head protected as per IP67G

With IP67G environment resistance, various measurements are possible under many different conditions.

### FUNCTIONS

#### Equipped with a zero-adjustment function

By pressing the zero-adjustment button, you can reset the output voltage to 0 V with one touch. (Resets the current output to 4 mA)

This function comes in handy when performing tolerance diagnosis of a masterwork to be used as the standard. Easy adjustment for product changes. (Remote operation is also possible) (by way of an external input.)



### MOUNTING

#### Sensor heads can be mounted in narrow spaces

If mounting standard types and different frequency types parallel to each other, they use up one-third the space needed for mounting compared to the same models. In addition, the GP-A14F type can be mounted close together and the sensor heads can be set in a narrow range for distortion and other difficult measurements.

### BASIC PERFORMANCE

#### Stable temperature characteristics

These sensor heads boast a 2 mm 0.079 in or more sensing range enabling 0.03 % F.S./ $^{\circ}$ C. (Excluding the different frequency type).

[ GP-A8S (For 2 mm 0.079 in sensing type)  
Temperature characteristics: 0.6  $\mu$ m/ $^{\circ}$ C 0.024 mil/ $^{\circ}$ C ]

### OPERABILITY

#### Fine adjustment of output

Fine adjustment according to the sensing conditions is possible with shift and span functions.

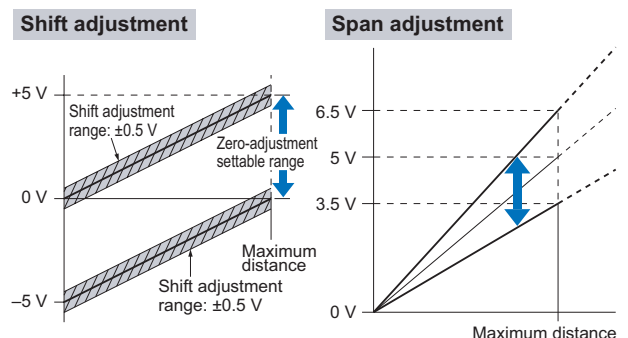

- Selection Guide
- Laser Displacement
- Magnetic Displacement
- Collimated Beam
- Digital Panel Controller
- Metal-sheet Double-feed Detection

- GP-X
- GP-A

**APPLICATIONS**

**Measuring gap between rollers**

Fine gap measurement is possible to control the gap between rollers.

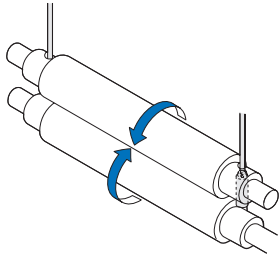

**Measuring parallelism of chassis**

Even a slight tilt can be reliably detected.

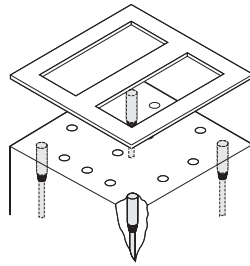

**ORDER GUIDE**

Type	Appearance (mm in)		Sensing range	Set model No.	Output
	Sensor heads	Amplifier			
For 1 mm 0.039 in sensing Non-threaded type sensor head Different frequency				GP-A5S	Analog voltage • Output voltage: 0 to 5 V  Analog current • Output current: 4 to 20 mA
				GP-A5SI	
For 2 mm 0.079 in sensing Non-threaded type sensor head Different frequency				GP-A8S	
				GP-A8SI	
For 2 mm 0.079 in sensing Threaded type sensor head Different frequency				GP-A10M	
				GP-A10MI	
For 5 mm 0.197 in sensing Threaded type sensor head Different frequency			GP-A12ML		
			GP-A12MLI		
For 3 mm 0.118 in sensing Front sensing type sensor head Different frequency			GP-A14F		
			GP-A14FI		

Please ensure to order the sensor head and the amplifier as a set. The set is calibrated and delivered.

**OPTIONS**

Type	Model No.	Description
Sensor head mounting bracket	MS-SS5	Mounting bracket for GP-A5S(I)
	MS-SS8	Mounting bracket for GP-A8S(I)

**Sensor head mounting bracket**

- MS-SS5
- MS-SS8

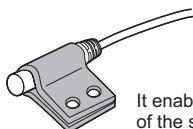

It enables easy fixing of the sensor head.

FIBER SENSORS

LASER SENSORS

PHOTO-ELECTRIC SENSORS

MICRO PHOTO-ELECTRIC SENSORS

AREA SENSORS

LIGHT CURTAINS / SAFETY COMPONENTS

PRESSURE / FLOW SENSORS

INDUCTIVE PROXIMITY SENSORS

PARTICULAR USE SENSORS

SENSOR OPTIONS

WIRE-SAVING UNITS

WIRE-SAVING SYSTEMS

MEASURE-MENT SENSORS

STATIC ELECTRICITY PREVENTION DEVICES

LASER MARKERS

PLC

HUMAN MACHINE INTERFACES

ENERGY CONSUMPTION VISUALIZATION COMPONENTS

FA COMPONENTS

MACHINE VISION SYSTEMS

UV CURING SYSTEMS

Selection Guide

Laser Displacement

Magnetic Displacement

Collimated Beam

Digital Panel Controller

Metal-sheet Double-feed Detection

GP-X

GP-A

## SPECIFICATIONS

Type	For 1 mm <b>0.039 in</b> sensing		For 2 mm <b>0.079 in</b> sensing				For 5 mm <b>0.197 in</b> sensing		For 3 mm <b>0.118 in</b> sensing		
	Non-threaded type sensor head		Non-threaded type sensor head		Threaded type sensor head		Threaded type sensor head		Front sensing type sensor head		
	Different frequency		Different frequency		Different frequency		Different frequency		Different frequency		
Item	Set model No.	<b>GP-A5S</b>	<b>GP-A5SI</b>	<b>GP-A8S</b>	<b>GP-A8SI</b>	<b>GP-A10M</b>	<b>GP-A10MI</b>	<b>GP-A12ML</b>	<b>GP-A12MLI</b>	<b>GP-A14F</b>	<b>GP-A14FI</b>
Sensing range		0 to 1 mm <b>0 to 0.039 in</b>		0 to 2 mm <b>0 to 0.079 in</b>				0 to 5 mm <b>0 to 0.197 in</b>		0 to 3 mm <b>0 to 0.118 in</b>	
Standard sensing object		Iron sheet 8 × 8 × t 1 mm <b>0.315 × 0.315 × t 0.039 in</b>		Iron sheet 12 × 12 × t 1 mm <b>0.472 × 0.472 × t 0.039 in</b>				Iron sheet 30 × 30 × t 1 mm <b>1.181 × 1.181 × t 0.039 in</b>		Iron sheet 15 × 15 × t 1 mm <b>0.591 × 0.591 × t 0.039 in</b>	
Supply voltage		24 V DC ±10 % Ripple P-P 10 % or less									
Current consumption		150 mA or less									
Analog output (Analog voltage output) (Analog current output)		Analog voltage • Output voltage: 0 to 5 V • Output impedance: 100 Ω approx.					Analog current • Output current: 4 to 20 mA • Load resistance: 0 to 350 Ω				
Response frequency		1.6 kHz (−3 dB)									
Resolution		0.04 % F.S.									
Linearity		Within ±0.5 % F.S.									
Alarm output		NPN open-collector transistor • Maximum sink current: 100 mA • Applied voltage: 30 V DC or less (between alarm output and 0 V) • Residual voltage: 1.6 V or less (at 100 mA sink current) 0.4 V or less (at 16 mA sink current)									
Output operation		Turns ON when the sensor head connection is improper or the sensor head cable is disconnected									
Short-circuit protection		—									
External zero-adjustment input		Input condition: Non-voltage contact or NPN open-collector transistor input Signal condition: Low ... 0 to 1 V (duration 30 ms or more) High ... 5 to 30 V, or open Operation: Low ... External zero-adjustment setting High ... External zero-adjustment ineffective									
Zero-adjustment setting method		Push button setting / External input setting									
Power indicator		Green LED (lights up when the power is ON)									
Over indicator		Orange LED (lights up when sensing range is exceeded)									
Alarm indicator		Yellow LED (lights up when the alarm output is ON)									
Adjustments		①Shift adjustment (by push-buttons), ②Span adjustment (by 14-turn adjuster)									
Temperature characteristics (Note 2)	Sensor head	0.5 μm/°C <b>0.020 mil/°C</b>	0.6 μm/°C <b>0.024 mil/°C</b>	1 μm/°C <b>0.039 mil/°C</b>	0.6 μm/°C <b>0.024 mil/°C</b>	1 μm/°C <b>0.039 mil/°C</b>	1.5 μm/°C <b>0.059 mil/°C</b>	2.5 μm/°C <b>0.098 mil/°C</b>	0.9 μm/°C <b>0.035 mil/°C</b>	1.5 μm/°C <b>0.059 mil/°C</b>	
	Amplifier	0.4 μm/°C <b>0.016 mil/°C</b>		0.8 μm/°C <b>0.031 mil/°C</b>			2.0 μm/°C <b>0.079 mil/°C</b>		1.2 μm/°C <b>0.047 mil/°C</b>		
Protection	Sensor head	IP67 (IEC), IP67G									
	Amplifier	—									
Ambient temperature	Sensor head	−10 to +55 °C <b>+14 to +131 °F</b> , Storage: −20 to +70 °C <b>−4 to +158 °F</b>									
	Amplifier	0 to +50 °C <b>+32 to +122 °F</b> (No dew condensation), Storage: 0 to +50 °C <b>+32 to +122 °F</b>									
Ambient humidity		35 to 85 % RH, Storage: 35 to 85 % RH									
Voltage withstandability	Sensor head	250 V AC for one min. between all supply terminals connected together and enclosure									
Insulation resistance	Sensor head	20 MΩ, or more, with 250 V DC megger between all supply terminals connected together and enclosure									
Vibration resistance	Sensor head	10 to 55 Hz frequency, 1.5 mm <b>0.059 in</b> amplitude in X, Y and Z directions for two hours each									
	Amplifier	10 to 150 Hz frequency, 0.75 mm <b>0.030 in</b> amplitude in X, Y and Z directions for two hours each									
Shock resistance	Sensor head	500 m/s <sup>2</sup> acceleration (50 G approx.) in X, Y and Z directions for five times each									
	Amplifier	100 m/s <sup>2</sup> acceleration (10 G approx.) in X, Y and Z directions for five times each									
Material	Sensor head	Enclosure: Stainless steel (SUS303) Sensing part: Polyallylate		Enclosure: Stainless steel (SUS303) Sensing part: ABS			Enclosure: Brass (Nickel plated) Sensing part: Nylon		Enclosure: Stainless steel (SUS303) Sensing part: ABS		
	Amplifier	Enclosure: ABS									
Cable	Sensor head	Connector attached high frequency coaxial cable, 3 m <b>9.843 ft</b> long									
Cable length (Note 3)	Amplifier	Total length up to 100 m <b>328.084 ft</b> is possible with 0.3mm <sup>2</sup> , or more, cable.									
Net Weight	Sensor head	40 g approx.				50 g approx. (Note 4)		45 g approx. (Note 4)		50 g approx.	
	Amplifier	170 g approx.									
Accessories		Adjusting screwdriver: 1 pc.				Nut: 2 pcs., Toothed lock washer: 1 pc. Adjusting screwdriver: 1 pc.				2 pcs. each of M3 countersunk head screws, spring washers, plain washers and M3 nuts Adjusting screwdriver: 1 pc.	

Notes: 1) Where measurement conditions have not been specified precisely, the conditions used were an ambient temperature of +20 °C **+68 °F**.

2) These values are for a range which is 20 to 60 % of the maximum sensing distance.

3) Take care that the output voltage is reduced due to the resistance of the wiring cable.

4) The given weight of the threaded type sensor head is the value including the weight of the nuts and the toothed lock washer.

## I/O CIRCUIT AND WIRING DIAGRAMS

### I/O circuit diagram

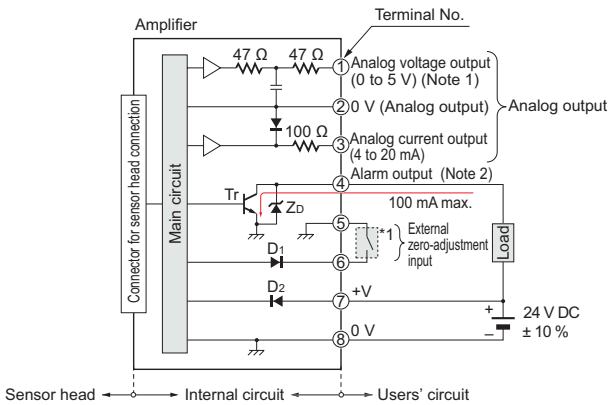

- Notes: 1) In case of using the analog voltage output, connect a device having a high input impedance. Also, take care that the output voltage is reduced due to the resistance of the wiring cable.  
 2) The alarm output is not incorporated with a short-circuit protection circuit. Do not connect it directly to a power supply or a capacitive load.

Symbols ... D1: Input protection diode  
 D2: Reverse supply polarity protection diode  
 Zb: Surge absorption zener diode  
 Tr: NPN output transistor

### Wiring diagram

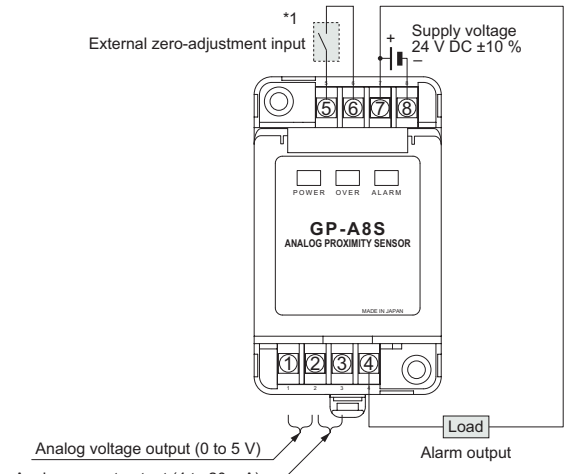

Note: After the wiring, make sure to fit the terminal cover having a concave depression at the top should be fitted on the side having terminal Nos. 1 to 4.

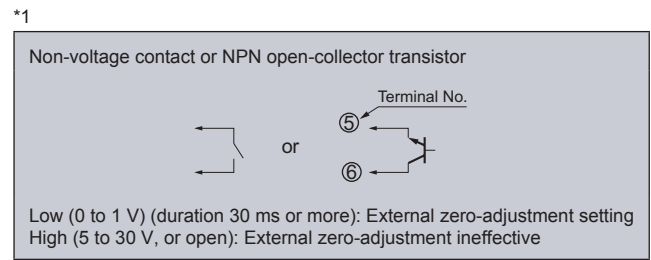

## SENSING CHARACTERISTICS (TYPICAL)

### Correlation between material and output voltage / current

The GP-A series is made for all types of standard iron sensing objects. The graph below describes the output discrepancies that occur when detecting different types of metals.

**GP-A5S(I)**

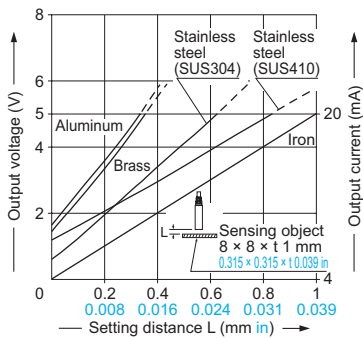

**GP-A8S(I) GP-A10M(I)**

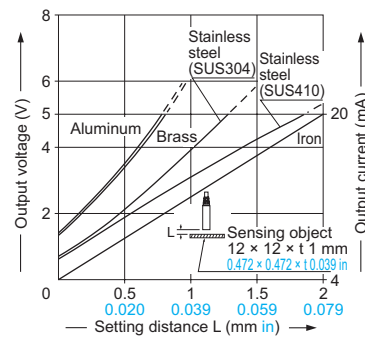

**GP-A12ML(I)**

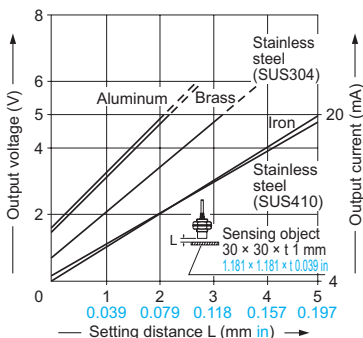

**GP-A14F(I)**

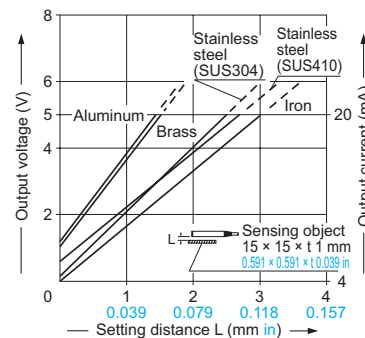

FIBER SENSORS

LASER SENSORS

PHOTO-ELECTRIC SENSORS

MICRO PHOTO-ELECTRIC SENSORS

AREA SENSORS

LIGHT CURTAINS / SAFETY COMPONENTS

PRESSURE / FLOW SENSORS

INDUCTIVE PROXIMITY SENSORS

PARTICULAR USE SENSORS

SENSOR OPTIONS

WIRE-SAVING UNITS

WIRE-SAVING SYSTEMS

MEASUREMENT SENSORS

STATIC ELECTRICITY PREVENTION DEVICES

LASER MARKERS

PLC

HUMAN MACHINE INTERFACES

ENERGY CONSUMPTION VISUALIZATION COMPONENTS

FA COMPONENTS

MACHINE VISION SYSTEMS

UV CURING SYSTEMS

Selection Guide

Laser Displacement

Magnetic Displacement

Collimated Beam

Digital Panel Controller

Metal-sheet Double-feed Detection

GP-X  
GP-A

**PRECAUTIONS FOR PROPER USE**

Refer to p.1501 for general precautions.



- Never use this product as a sensing device for personnel protection.
- In case of using sensing devices for personnel protection, use products which meet laws and standards, such as OSHA, ANSI or IEC etc., for personnel protection applicable in each region or country.

- Make sure to use in combination the sensor head and amplifier which have the same production serial number (5 digits). Since adjustment is done before shipment, if items with different production serial numbers are combined, the sensing characteristics will deteriorate even if they have the same model number.
- The length of the sensor head cable cannot be changed.

**Linearity in case of disc-shaped or cylindrical objects**

- In case the sensing object is disc-shaped or cylindrical, the linearity of the analog output varies with the sensing object size. In such a case, conduct zero adjustment when close mounting and, by adjusting to the maximum sensing distance and to 5 V as the voltage output (current output 20 mA), linearity ( $\pm 0.5\%$  F.S.) can be attained on a full-scale if the sensing object's size is larger than those described in the table below.

Model No.	Iron disc diameter $\phi$ (mm in)	Iron cylinder diameter $\phi$ (mm in)
GP-A5S(I)	12 0.472	10 0.394
GP-A8S(I)	12 0.472	10 0.394
GP-A10M(I)	12 0.472	10 0.394
GP-A12ML(I)	30 1.118	50 1.969
GP-A14F(I)	12 0.472	10 0.394

**<In case of disc>**

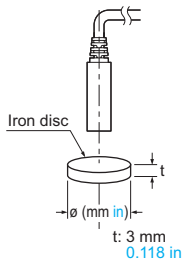

**<In case of cylinder>**

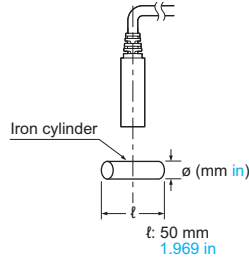

**Mounting sensor head**

**Mounting with set screw**

- The tightening torque should be under the value given below.
- Make sure to use an M3 or smaller set screw having a cup-point.

**<Non-threaded type sensor head>**

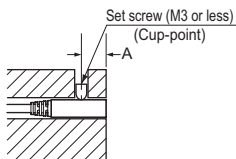

Model No.	A (mm in)	Tightening torque
GP-A5S(I)	5 0.197	0.44 N·m
GP-A8S(I)	or more	0.58 N·m

Note: Do not apply excess torque.

**Mounting with nut**

- The tightening torque should be under the value given below.

**<Threaded type sensor head>**

GP-A10M(I)	GP-A12ML(I)	Model No.	B (mm in)	Tightening torque
		GP-A10M(I)	7 0.276 or more	9.8 N·m
		GP-A12ML(I)	14 0.551 or more	20 N·m

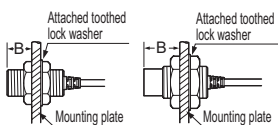

Note: Install in such a way so that the nut does not protrude from the screw.

**Mounting GP-A14(I)**

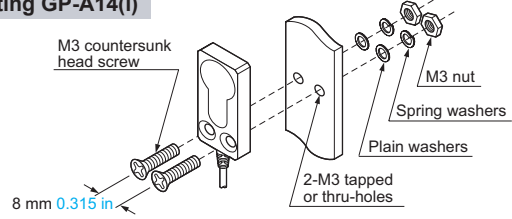

**Distance from surrounding metal**

- As metal around the sensor may affect the sensing performance, pay attention to the following points.

**<Embedding of the sensor in metal>**

- Since the analog output may change if the sensor is completely embedded in metal, keep the minimum distance specified in the table below.

(Non-threaded type sensor head)  
(threaded type sensor head)

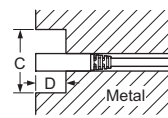

<Front sensing type sensor head>

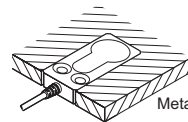

Model No.	C (mm in)	D (mm in)
GP-A5S(I)	$\phi 18$ $\phi 0.709$	4 0.157
GP-A8S(I)		7 0.276
GP-A10M(I)	$\phi 50$ $\phi 1.969$	14 0.551
GP-A12ML(I)		

- GP-A14F(I) can be used by being completely embedded in metal. However, the surrounding metal should not protrude beyond the sensing face.

**Mutual interference**

- When two or more sensor heads are installed in parallel or face to face, since the specifications may not be met, keep the minimum separation distance specified in the table below.

(Non-threaded type sensor head)  
(threaded type sensor head)  
(Front sensing type sensor head)

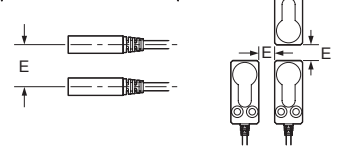

Model No.	E (mm in)	
	Between "I" type and non-"I" type	Between two "I" types or two non-"I" types
GP-A5S(I)	11 0.433	36 1.417
GP-A8S(I)	11 0.433	38 1.496
GP-A10M(I)		
GP-A12ML(I)	14 0.551	130 5.118
GP-A14F(I)	0 0	30 1.181

Notes: 1) "I" type is different frequency type.

2) If the required resolution is lower than the specification (0.04 % F.S.), it is possible to bring the sensor heads nearer than the separation distances given in the table above. For further details, please contact our office.

**Dimensions of suitable crimp terminals**

(Unit: mm in)

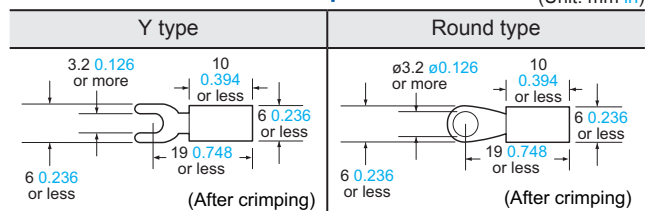

Note: Please use crimp terminals which have insulation sleeves.

Recommended crimp terminal: Type 1.25 - 3.0

**Others**

- Do not use during the initial transient time (0.5 sec.) after the power supply is switched on.
- Do not use the sensor at places having intense vibrations, as this can cause malfunction.

FIBER SENSORS  
LASER SENSORS  
PHOTO-ELECTRIC SENSORS  
MICRO PHOTO-ELECTRIC SENSORS  
AREA SENSORS  
LIGHT CURTAINS / SAFETY COMPONENTS  
PRESSURE / FLOW SENSORS  
INDUCTIVE PROXIMITY SENSORS  
PARTICULAR USE SENSORS  
SENSOR OPTIONS  
SIMPLE WIRE-SAVING UNITS  
WIRE-SAVING SYSTEMS  
MEASURE-HEAT SENSORS  
STATIC ELECTRICITY PREVENTION DEVICES  
LASER MARKERS  
PLC  
HUMAN MACHINE INTERFACES  
ENERGY CONSUMPTION VISUALIZATION COMPONENTS  
FA COMPONENTS  
MACHINE VISION SYSTEMS  
UV CURING SYSTEMS

Selection Guide  
Laser Displacement  
Magnetic Displacement  
Collimated Beam  
Digital Panel Controller  
Metal-sheet Double-feed Detection

GP-X  
GP-A

